

Interface transceiver of RS-232 standard with one supply voltage

ILX3232

IC ILX3232 is purposed for application in high-performance information processing systems and control devices of wide application.

Input voltage levels are compatible with standard CMOS levels.

- Output voltage levels are compatible with input levels of K-MOS, N-MOS and TTL integrated circuits.
- Supply voltage : 3.3V
- Low input current: 1.0 μA ; 0.1 μA at $T = 25\text{ }^\circ\text{C}$.
- Output current 24 mA.
- Latching current not less than 450 mA at $T = 25\text{ }^\circ\text{C}$
- Tolerable value of static potential not less than 2000V

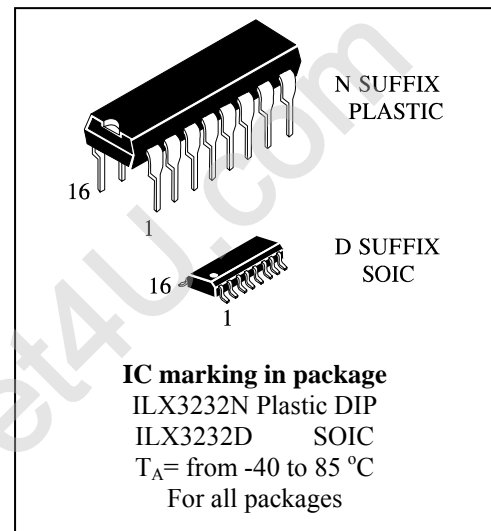

Truth table

Inputs	Outputs
R_{IN}, T_{IN}	R_{OVT}, T_{OVT}
H	L
L	H

Note -
H – voltage high level;
L – low voltage level

Pin symbols in package

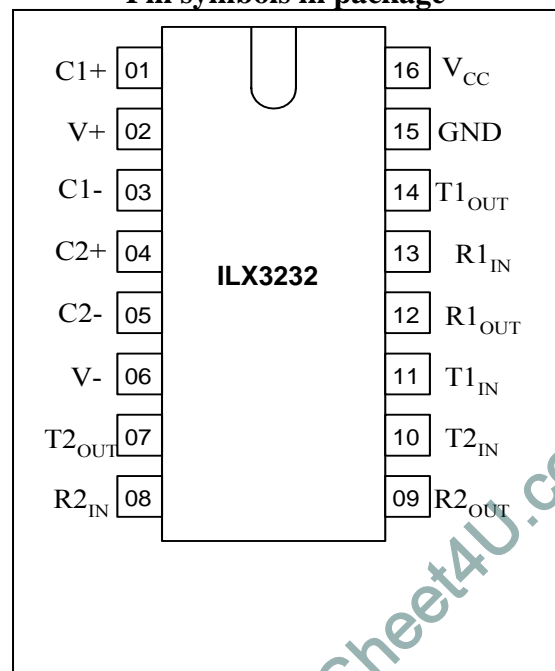

Table of pin description

Pin No.	Symbol	Pin name
01	C1+	Output of external capacitance of positive voltage multiplier unit
02	V+	Output of positive voltage of multiplier unit
03	C1-	Output of external capacitance of positive voltage multiplier unit
04	C2+	Output of external capacitance of negative voltage multiplier unit
05	C2-	Output of external capacitance of negative voltage multiplier unit
06	V-	Output of negative voltage of multiplier unit
07	T2 _{OUT}	Output of transmitter data (levels RS – 232)
08	R2 _{IN}	Input of receiver data (levels RS – 232)
09	R2 _{OUT}	Output of receiver data (levels TTL/KMOS)
10	T2 _{IN}	Input of transmitter data (levels TTL/KMOS)
11	T1 _{IN}	Input of transmitter data (levels TTL/KMOS)
12	R1 _{OUT}	Output of receiver data (levels TTL/KMOS)
13	R1 _{IN}	Input of receiver data (levels RS – 232)
14	T1 _{OUT}	Output of transmitter data (levels RS – 232)
15	GND	Common output
16	V _{CC}	Supply output of voltage source

Maximum conditions

Symbol	Parameter	Rate		Unit
		min	max	
V _{CC}	Supply voltage	-0.3	6.0	V
V+	Transmitter high output voltage	V _{CC} - 0.3	14	
V-	Transmitter low output voltage	-0.3	-14	
V _{TIN}	Transmitter input voltage	-0.3	V+ + 0.3	
V _{RIN}	Receiver input voltage	-30	30	
P _D	Dissipated power	-	842	mW
	DIP – package SO - package			
I _{SC}	Output current of transmitter short circuit	-	Continuously	mA
T _a	Ambient temperature	-60	150	°C

Recommended Operating Conditions

Symbol	Parameter	Rate		Unit
		min	max	
V _{CC}	Supply voltage	3.0	5.5	V
V ₊	Transmitter output high voltage	V _{CC}	-	
V ₋	Transmitter output low voltage	-V _{CC}	-	
V _{TIN}	Transmitter input voltage	0	V _{CC}	
V _{RIN}	Receiver input voltage	-30	30	
I _{SC}	Transmitter short circuit output current	-	±60	mA
T _a	Ambient temperature	-40	85	°C

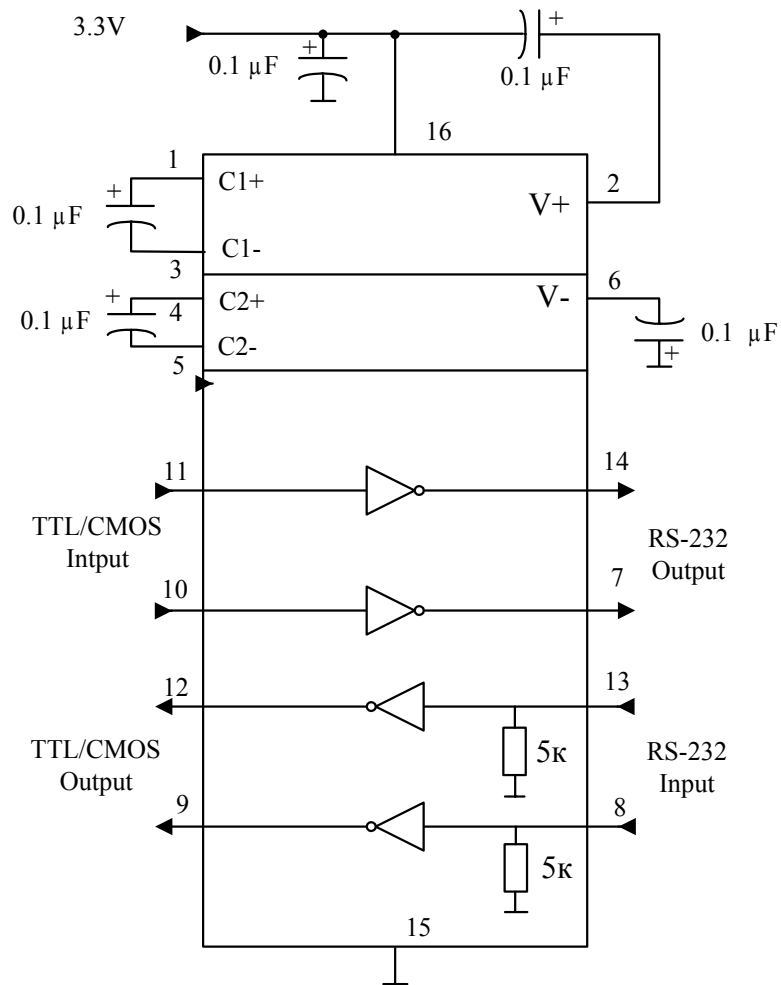

Static parameters

Symbol	Parameter	Test conditions	Rate				Unit
			25°C		-40 °C to 85 °C		
			min	max	min	max	
I _{CC}	Consumption current static	V _{CC} = 3.3 V V _{IL} = 0 V	-	10.0	-	14.0*	mA

Receiver electrical parameters

V _h	Hysteresis voltage	V _{CC} = 3.3 V	0.2	0.9	0.2	1.0	V
V _{On}	On (operation) voltage	V _O ≤ 0.1 V I _{OL} ≤ 20 μA	-	2.4	-	2.3	
V _{off}	Off (dropout) voltage	V _O ≥ V _{CC} - 0.1 V I _{OH} ≤ -20 μA	0.6	-	0.7	-	
V _{OL}	Output low voltage	I _{OL} = 3.2 mA V _{CC} = 3.0 V V _{IH} = 2.4 V	-	0.3	-	0.4	
V _{OH}	Output high voltage	I _{OH} = -1.0 mA V _{CC} = 3.0 V V _{IL} = 0.8 V	2.4	-	2.3	-	
R _I	Input resistance	V _{CC} = 3.3 V	3.0	7.0	3.0	7.0	kOhm

Transmitter electrical parameters

V _{OL}	Output low voltage	V _{CC} = 3.0 V V _{IH} = 2.0 V R _L = 3.0 kOhm	-	-3.5	-	-3.3	V
V _{OH}	Output high voltage	V _{CC} = 3.0 V V _{IL} = 0.8 V R _L = 3.0 kOhm	3.5	-	3.3	-	
I _{IL}	Input low current	V _{CC} = 3.3 V V _{IL} = 0 V	-	-1.0	-	-10.0	μA
I _{IH}	Input high current	V _{CC} = 3.3 V V _{IH} = V _{CC}		1.0		10.0	
SR	Speed of output front change	V _{CC} = 3.3 V C _L = 50 - 1000 pF R _L = 3.0 - 7.0 kOhm	3.0	30	2.7	27	V/μs
R _O	Output resistance	V _{CC} = V ₊ = V ₋ = 0 V V _O = ± 2 V	350	-	300	-	Ohm
I _{SC}	Short circuit output current	V _{CC} = 3.3 V V _O = 0 V V _I = V _{CC} V _I = 0 V		-50 50		-60 60	mA
ST	Speed of information transmission	V _{CC} = 3.0 V C _L = 1000 pF R _L = 3.0 kOhm t _w = 7 μs (for extreme -t _w = 8mks)	140	-	120	-	

Dynamic parameters

Symbol	Parameter	Test conditions	Rate				Unit
			25 °C		from -40 °C to 85 °C		
			min	max	min	max	
t_{PHLR} (t_{PLHR})	Signal propagation delay time when switching on (off)	$V_{CC} = 3.0\text{ V}$ $C_L = 150\text{ pF}$ $V_{IL} = 0\text{ V}$ $V_{IH} = 3.0\text{ V}$ $t_{LH} = t_{HL} \leq 10\text{ ns}$	-	9.7	-	10	μs
t_{PHLT} (t_{PLHT})	Signal propagation delay time when switching on (off)	$V_{CC} = 3.0\text{ V}$ $C_L = 2500\text{ pF}$ $V_{IL} = 0\text{ V}$ $V_{IH} = 3.0\text{ V}$ $R_L = 3\text{ k}\Omega$ $t_{LH} = t_{HL} \leq 10\text{ ns}$		5.0*		6.0*	

Capacitance

Symbol	Parameter	V_{CC}	Rate	Unit
C_{IN}	Input capacitance	3.3	9.0	pF
C_{PD}	Dynamic capacitance		90	

Timing diagram when measuring IC dynamic parameters

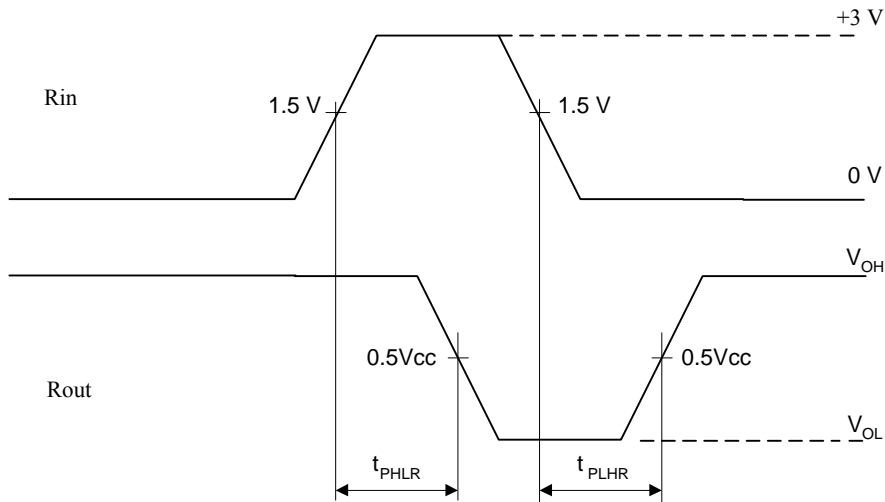

Figure 3

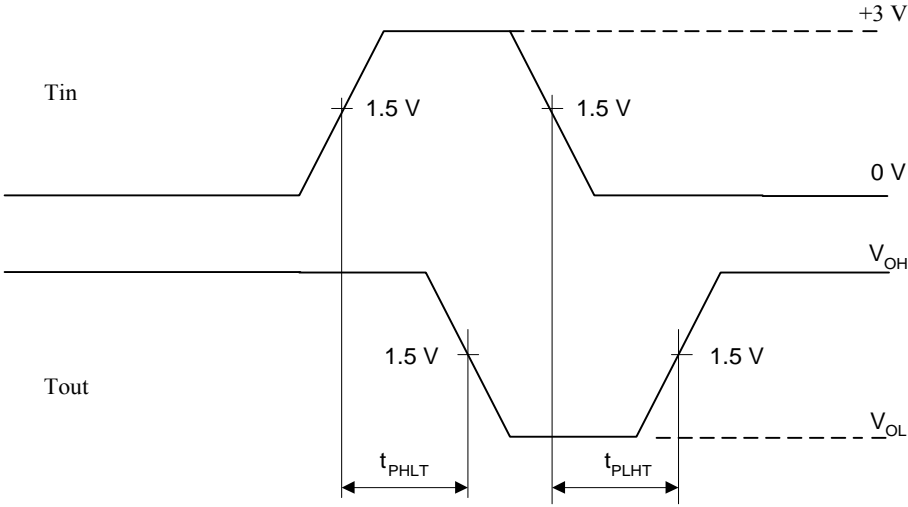

Figure 4

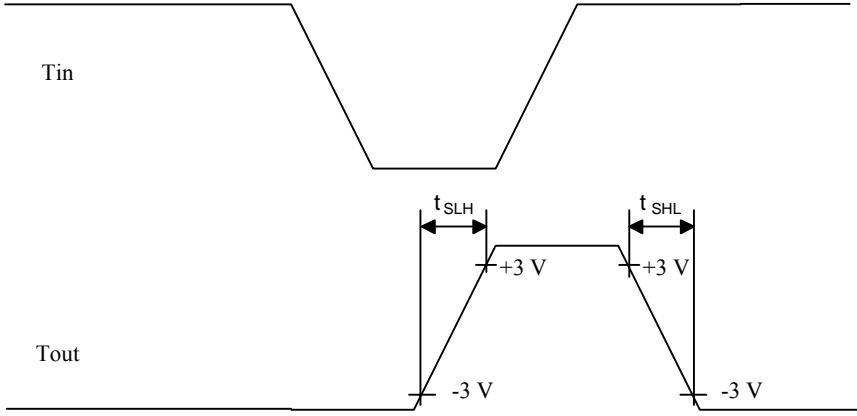

Figure 5

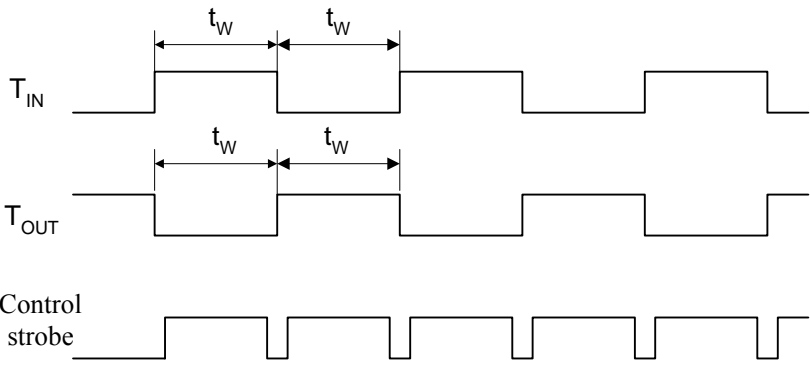

Figure 6

TYPICAL PERFORMANCE CHARACTERISTICS (unless otherwise specified $T_j = 25^\circ\text{C}$)

Figure 1 : Driver Voltage Transfer Characteristics for Transmitter Inputs

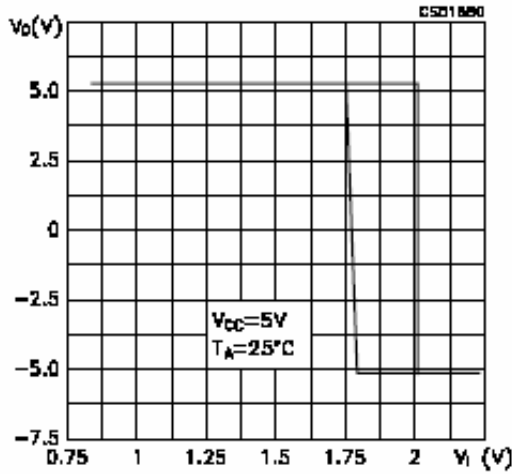

Figure 4 : Output Current vs Output Low Voltage

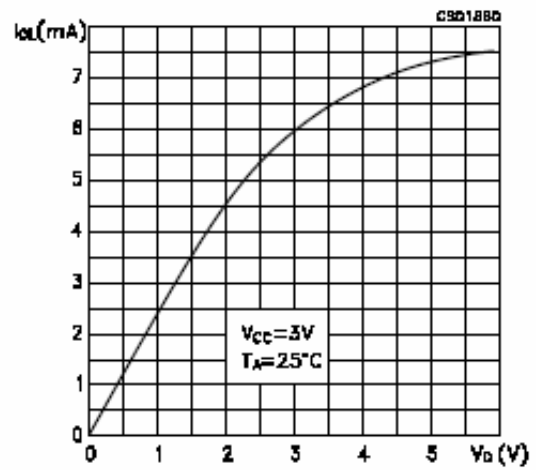

Figure 2 : Driver Voltage Transfer Characteristics for Receiver Inputs

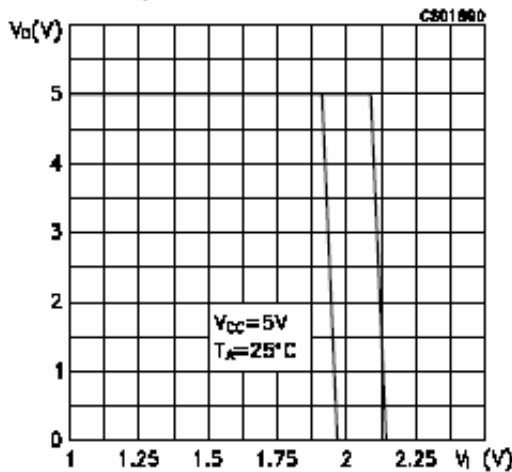

Figure 5 : Output Current vs Output High Voltage

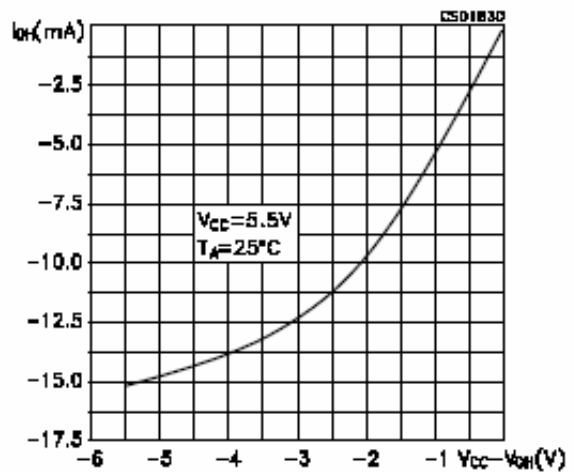

Figure 3 : Output Current vs Output Low Voltage

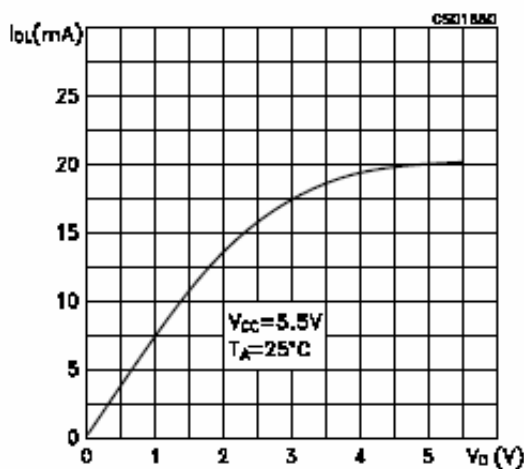

Figure 6 : Output Current vs Output High Voltage

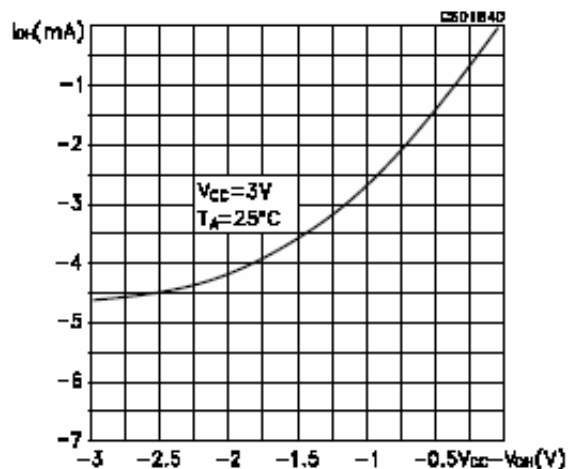
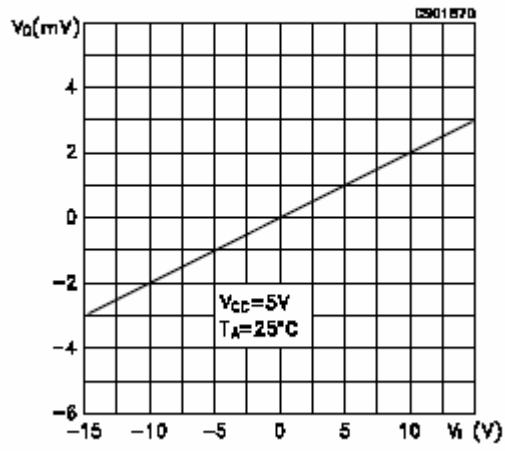
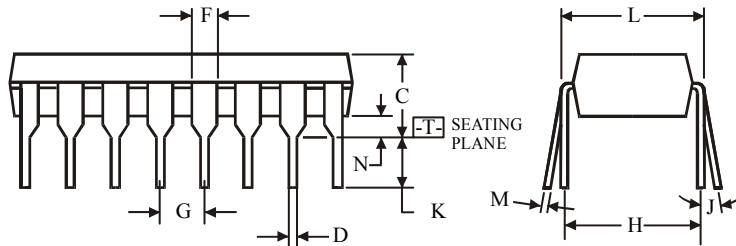
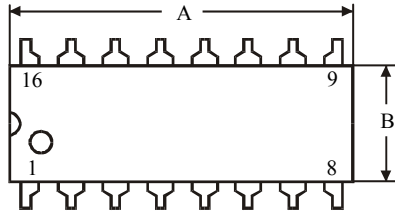
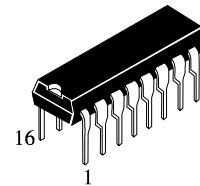

Figure 7 : Receiver Input Resistance



**N SUFFIX PLASTIC DIP
(MS - 001BB)**



$\oplus 0.25 (0.010) \text{ (M) } T$

NOTES:

- Dimensions "A", "B" do not include mold flash or protrusions.
Maximum mold flash or protrusions 0.25 mm (0.010) per side.

Dimension, mm		
Symbol	MIN	MAX
A	18.67	19.69
B	6.1	7.11
C		5.33
D	0.36	0.56
F	1.14	1.78
G	2.54	
H	7.62	
J	0°	10°
K	2.92	3.81
L	7.62	8.26
M	0.2	0.36
N	0.38	

**D SUFFIX SOIC
(MS - 012AC)**

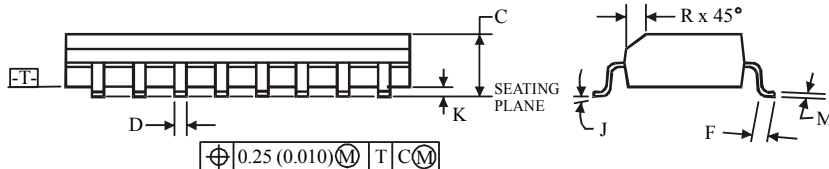
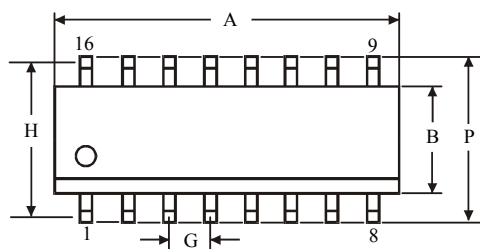
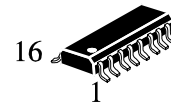

$\oplus 0.25 (0.010) \text{ (M) } T \text{ (C) (M)}$

NOTES:

- Dimensions A and B do not include mold flash or protrusion.
- Maximum mold flash or protrusion 0.15 mm (0.006) per side for A; for B - 0.25 mm (0.010) per side.

Dimension, mm		
Symbol	MIN	MAX
A	9.8	10
B	3.8	4
C	1.35	1.75
D	0.33	0.51
F	0.4	1.27
G	1.27	
H	5.72	
J	0°	8°
K	0.1	0.25
M	0.19	0.25
P	5.8	6.2
R	0.25	0.5