

SPECIFICATIONS

PRODUCT : LCD MODULE

MODEL NO. : S95160

CUSTOMER			SUCCESS		
APPROVED	CHECKED	CHECKED	APPROVED	CHECKED	PREPARED

APPROVAL FOR SPECIFICATIONS ONLY

APPROVAL FOR SPECIFICATIONS AND SAMPLE

深圳市宇顺电子有限公司

SUCCESS ELECTRONIC CO., LTD.

RECORDS OF REVISION

DATE	REVISED NO.	REVISED DESCRIPTIONS	PREPARED	CHECKED	APPROVED
2007-4-5	01	FIRST ISSUE	Daniel. YU	Daniel. YU	
2007-4-18	02	Modify the viewing angle	Com.W		
2007-7-30	03	Modify the backlight parameters	Com.W		

STANDARD DOC.	PRODUCT SPEC.	MODULE NO.	S95160	PAGE	2
------------------	------------------	---------------	--------	------	---

CONTENTS

1.	GENERAL SPECIFICATIONS	3
2.	FEATURES	3
3.	MECHANICAL SPECIFICATIONS	3
4.	OUTLINE DIMENSIONS	4
5.	INTERFACE ASSIGNMENT	5
6.	BLOCK DIAGRAM	6
7.	TIMING CHARACTERISTICS	7
8.	RESET TIMING CHARACTERISTICS	8
9.	DDRAM ARRANGMENT	9
10.	ABSOLUTE MAXIMUM RATINGS	10
11.	ELECTRICAL CHARACTERISTICS	10
12.	LED BACKLIGHT CHARACTERISTICS	11
13.	OPTICAL CHARACTERISTICS	12
14.	ENVIRONMENTAL ABSOLUTE MAXIMUM RATINGS	15
15.	RELIABILITY TEST	15
16.	THE STANDARD OF INSPECTION	16
17.	USING LCD MODULES	19

STANDARD DOC.	PRODUCT SPEC.	MODULE NO.	S95160	PAGE	3
------------------	------------------	---------------	--------	------	---

1. GENERAL SPECIFICATIONS

1-1 SCOPE:

This specification covers the delivery requirements for the liquid crystal display delivered by SUCCESS ELECTRONIC to Customer ◦

1-2 PRODUCTS:

Liquid Crystal Display Module (LCM)

1-3 MODULE NAME:

S95160

2. FEATURES

- (1) Display Type: 3.2" TFT, Transmissive, 3 o'clock, Normal White.
- (2) With white LED Backlight
- (3) Control IC SSD1289Z

3. MECHANICAL SPECIFICATIONS

ITEM	SPECIFICATIONS	UNIT
OUTLINE DIMENSIONS	57.54(W) x 79.2(H) x 4.6(T)	mm
ACTIVE AREA	48.6 (W) x 64.8(H)	mm
DISP.CONSTRUCTION	240(RGB) x 320 Dots	PIXELS
NUMBER OF DOTS	240 x 3 x 320	Dots
PIXEL PITCH	0.2025X0.2025	mm
ASSY.TYPE	COG+FPC	---
BACKLIGHT	WHITE LED	—
WEIGHT	TBD	g

4.OUTLINE DIMENSIONS

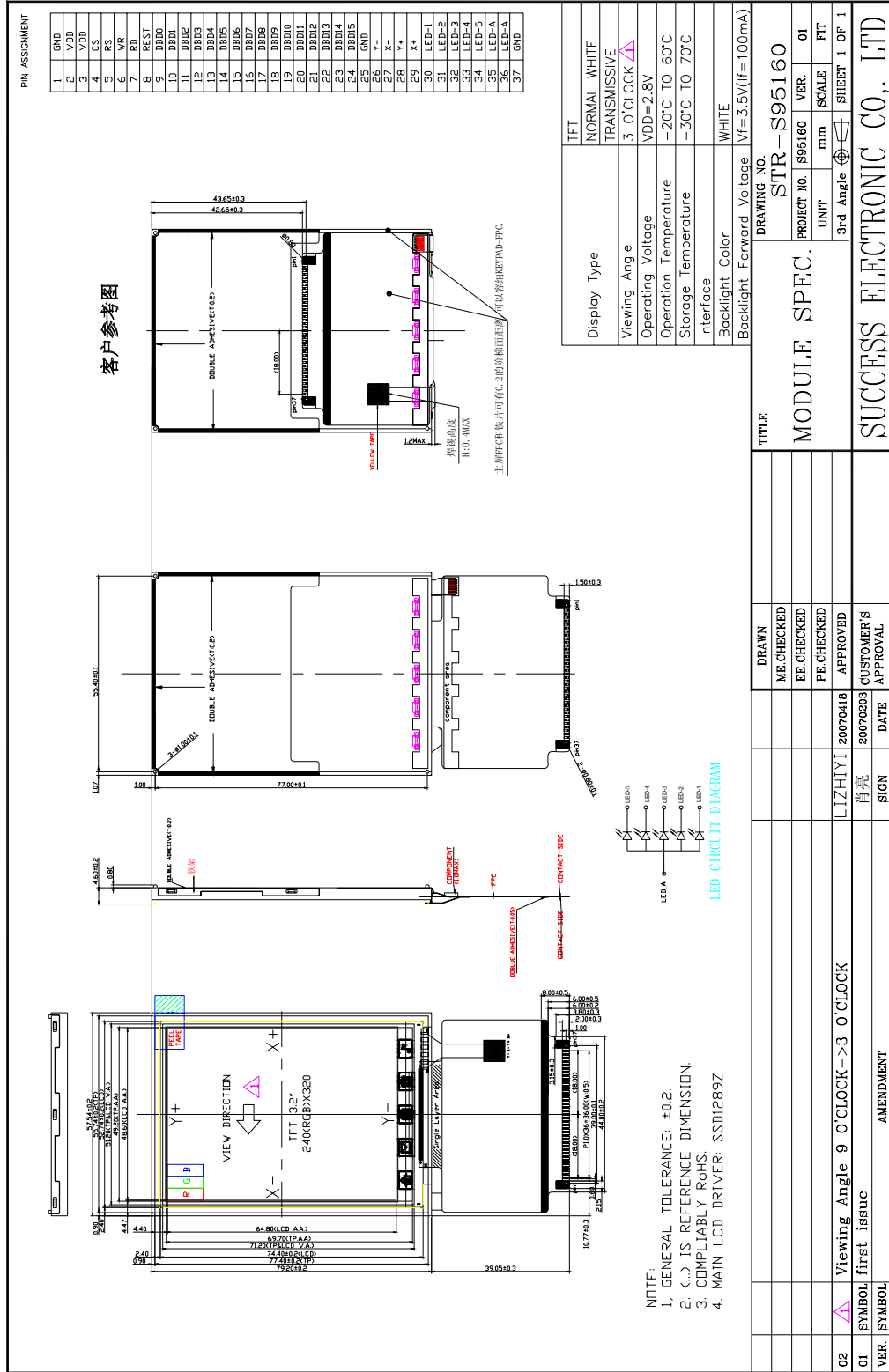

STANDARD DOC.	PRODUCT SPEC.	MODULE NO.	S95160	PAGE	5
------------------	------------------	---------------	--------	------	---

5. INTERFACE ASSIGNMENT

PIN NO.	FUNCTION DESCRIPTIONS	SYMBOL
1	Ground	GND
2	Power supply for analog and logic	VDD
3	Power supply for analog and logic	VDD
4	Chip enable signal , chip can be accessed when it is low	CS
5	The signal for register index (RS=1)or register command(RS=0) select	RS
6	Serves as a write signal and writes data at the rising edge in i80 system interface	WR
7	Serves as a read signal and read data at the low level in i80 system interface	RD
8	Reset pin, can reset the chip at the low level	REST
9	Data bus 0	DBD0
10	Data bus 1	DBD1
11	Data bus 2	DBD2
12	Data bus 3	DBD3
13	Data bus 4	DBD4
14	Data bus 5	DBD5
15	Data bus 6	DBD6
16	Data bus 7	DBD7
17	Data bus 8	DBD8
18	Data bus 9	DBD9
19	Data bus 10	DBD10
20	Data bus 11	DBD11
21	Data bus 12	DBD12
22	Data bus 13	DBD13
23	Data bus 14	DBD14
24	Data bus 15	DBD15
25	Ground	GND
26	Touch panel input pin	Y-
27	Touch panel input pin	X-
28	Touch panel input pin	Y+
29	Touch panel input pin	X+
30	Power supply for LED-	LED-1
31	Power supply for LED-	LED-2
32	Power supply for LED-	LED-3
33	Power supply for LED-	LED-4
34	Power supply for LED-	LED-5
35	Power supply for LED+	LED-A
36	Power supply for LED+	LED-A
37	Ground	GND

SUCCESS ELECTRONIC CO.,LTD.

6.APPLICATION CUICIRT

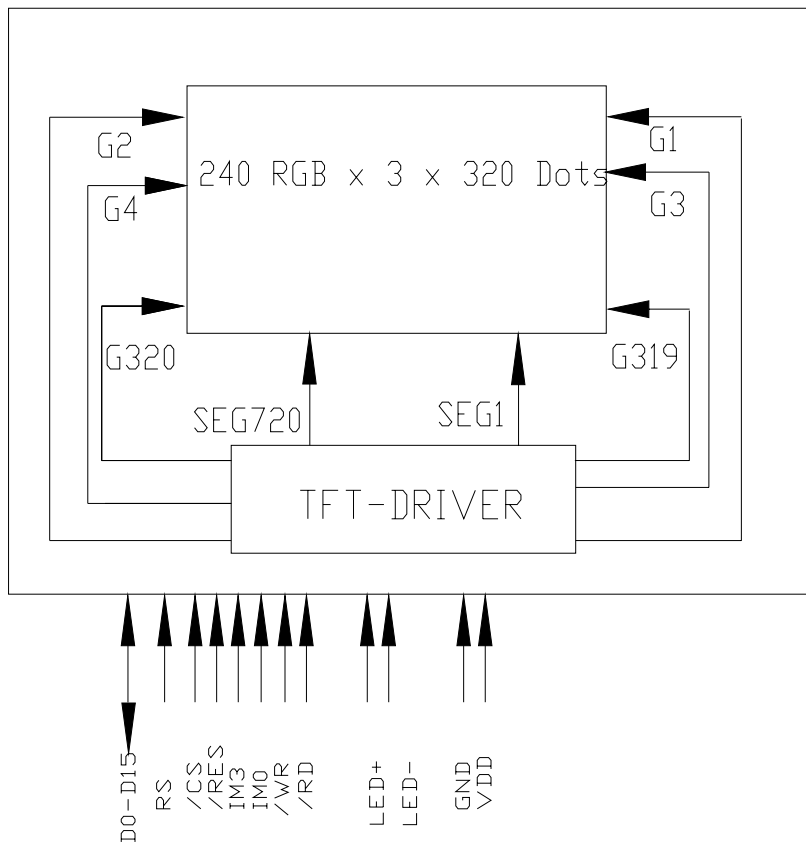
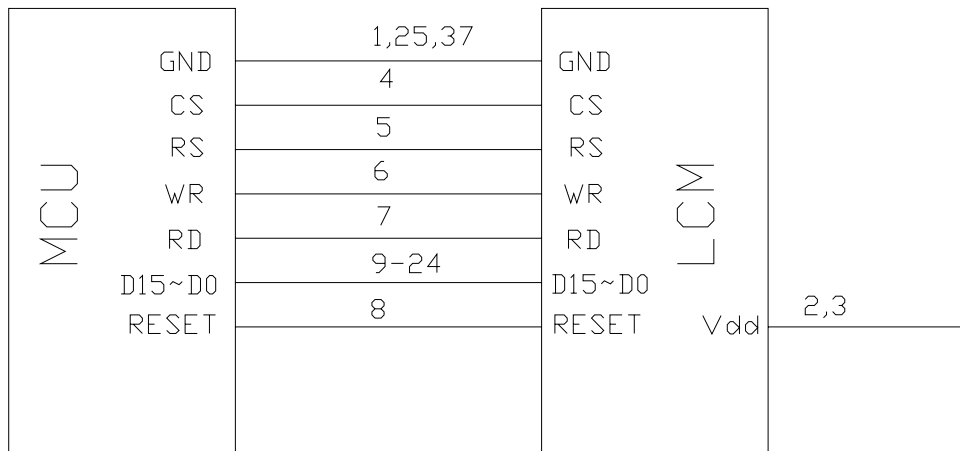

7.1 80SYSTEM TIMING CHARACTERISTICS

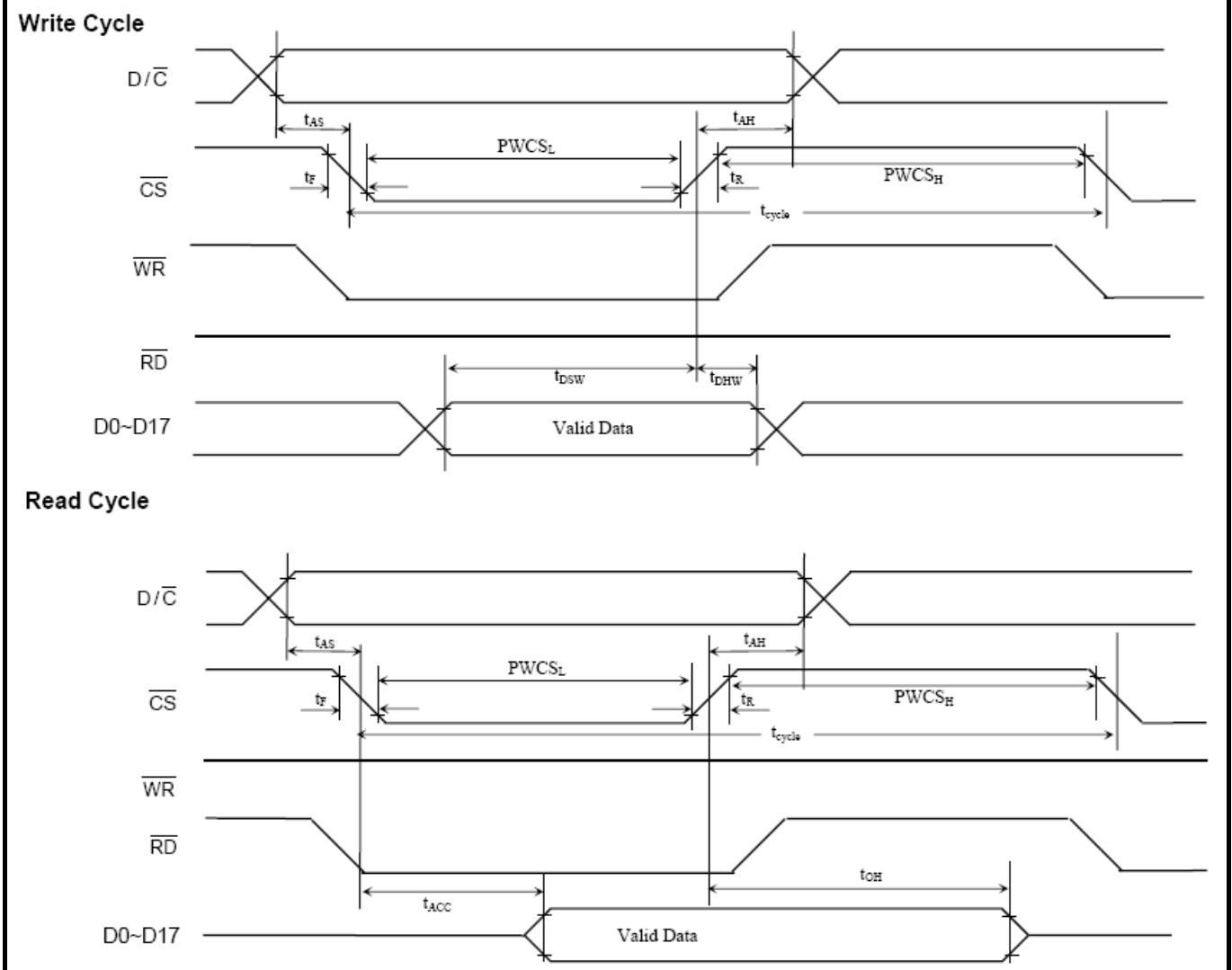

Figure 13-2 –Parallel 8080-series Interface Timing Characteristics

9. DDRAM ARRANGEMENT

		RL=1	S0	S1	S2	S3	S4	S5	S6	S7	S8	...	S714	S715	S716	S717	S718	S719					
		RL=0	S719	S718	S717	S716	S715	S714	S713	S712	S711	...	S5	S4	S3	S2	S1	S0					
		BGR=0	R	G	B	R	G	B	R	G	B	...	R	G	B	R	G	B					
		BGR=1	B	G	R	B	G	R	B	G	R	...	B	G	R	B	G	R					
TB=1	TB=0																		Vertical address				
G0	G319	0000H,0000H				0000H,0001H				0000H,0010H				...	0000H,00EEH				0000H,00EFH				0
G1	G318	0001H,0000H				0001H,0001H				0001H,0010H				...	0001H,00EEH				0001H,00EFH				1
G2	G317	0010H,0000H				0010H,0001H				0010H,0010H				...	0010H,00EEH				0010H,00EFH				2
G3	G316	0011H,0000H				0011H,0001H				0011H,0010H				...	0011H,00EEH				0011H,00EFH				3
G4	G315	0100H,0000H				0100H,0001H				0100H,0010H				...	0100H,00EEH				0100H,00EFH				4
.
.
.
G316	G3	013CH,0000H				013CH,0001H				013CH,0010H				...	013CH,00EEH				013CH,00EFH				316
G317	G2	013DH,0000H				013DH,0001H				013DH,0010H				...	013DH,00EEH				013DH,00EFH				317
G318	G1	013EH,0000H				013EH,0001H				013EH,0010H				...	013EH,00EEH				013EH,00EFH				318
G319	G0	013FH,0000H				013FH,0001H				013FH,0010H				...	013FH,00EEH				013FH,00EFH				319

Horizontal address

0	1	2	...	238	239
---	---	---	-----	-----	-----

Remark : The address is in 00xxH,0yyyH format, where yyy is the vertical address and xx is the horizontal address

STANDARD DOC.	PRODUCT SPEC.	MODULE NO.	S95160			PAGE	9
------------------	------------------	---------------	--------	--	--	------	---

10. ABSOLUTE MAXIMUM RATING

ITEM	SYMBOL	CONDITION	STANDARD VALUE			UNIT
			MIN	TYP	MAX	
POWER SUPPLY FOR LOGIC	VDD—VSS	Ta=25°C	-0.3	—	4.0	V
INPUT VOLTAGE	VIN	Ta=25°C	-0.3	—	VDD+0.3	V
OPERATION TEMPERATURE	TOPR	---	- 20	—	70	°C
STORAGE TEMPERATURE	TSTG	---	- 30	—	+80	°C

NOTES:

(1) LCM should be grounded during handling LCM.

11. ELECTRICAL CHARACTERISTICS

ITEM	SYMBOL	CONDITIONS	STANDARD VALUE			UNIT
			MIN	TYP	MAX	
POWER SUPPLY VOLTAGE	VDD—VSS	Ta= +25°C	-	2.8	-	V
POWER SUPPLY FOR LCD DRIVING	Vlcd	Ta= +25°C	-	7.8	-	V
INPUT VOLTAGE "H" LEVEL	VIH	—	0.8VDD	—	VDD	V
INPUT VOLTAGE "L" LEVEL	VIL	—	VSS	—	0.2VDD	V
OUTPUT VOLTAGE "H" LEVEL	VOH	IOH=-100uA	0.8VDD	—	VDD	V
OUTPUT VOLTAGE "L" LEVEL	VOL	IOL=100uA	VSS	—	0.2VDD	V

12. LED BACKLIGHT

12-1 POWER SUPPLY FOR LED BACKLIGHT

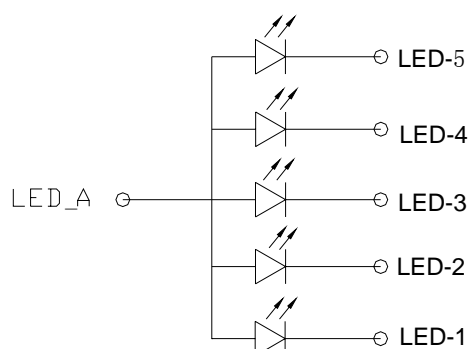

12-2 ABSOLUTE MAXIMUM RATING

PARAMETER	SYMBOL	SPECIFICATIONS	UNIT
POWER DISSIPATION	PD	350	mW
OPERATION TEMPERATURE	TOPR	-20°C ~ +70°C	°C
STORAGE TEMPERATURE	TSTG	-30°C ~ +80°C	°C

12-3 ELECTRICAL CHARACTERISTICS

PARAMETER	SYMBOL	REMARK	STANDARD VALUE			UNIT
			MIN	TYP	MAX	
FORWARD VOLTAGE	VF	If = 100MA	3.0	3.2	3.4	V
LUMINOUS INTENSITY	Iv	If = 100MA	3000	3200	3500	cd/m ²
LUMINOUS TOLERANCE	Iv-m	(min/max)/100	80	—	—	%

STANDARD DOC.	PRODUCT SPEC.	MODULE NO.	S95160	PAGE	11
------------------	------------------	---------------	--------	------	----

13.OPTICAL CHARACTERISTICS

Item	Symbol	Conditions	Specifications			Unit	Note	
			Min.	Typ.	Max.			
Transmittance	T%	Viewing normal angle $\theta_x = \theta_y = 0^\circ$	NA	5.5	NA	%	All left side data are based on CMO's following condition -- Type 767 NTSC: 60% LC: 5091 Light : C light (Machine:BM5A) Polarizer without DBEF Reference Only	
Contrast Ratio	CR		150	250	NA	--		
Response Time	T_R		NA	15	20	ms		
	T_F		NA	35	50	ms		
Chromaticity	Red		X_R	0.608	0.638	0.668		
			Y_R	0.296	0.326	0.356		
	Green		X_G	0.267	0.297	0.327		
			Y_G	0.549	0.579	0.609		
	Blue		X_B	0.104	0.134	0.164		
			Y_B	0.081	0.111	0.141		
White	X_W	0.285	0.315	0.345				
	Y_W	0.315	0.345	0.375				
Viewing Angle	Hor.	θ_{x+}	-	45	-	deg.		
		θ_{x-}	-	45	-			
	Ver.	θ_{y+}	-	35	-			
		θ_{y-}	-	15	-			

(1) DEFINITION OF VIEWING ANGLE

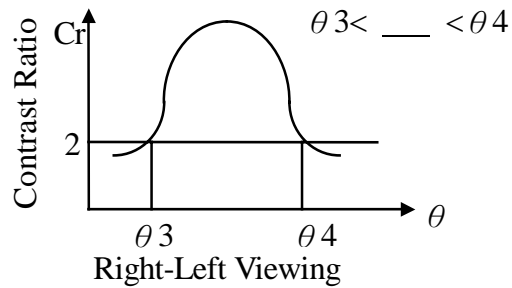
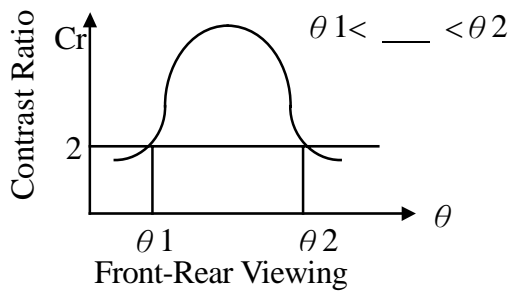
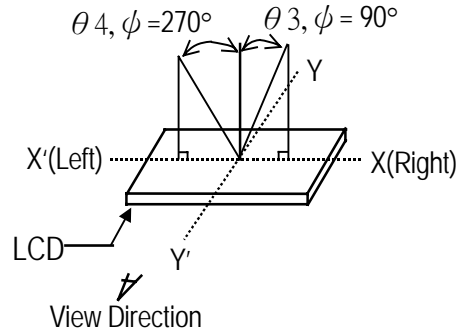
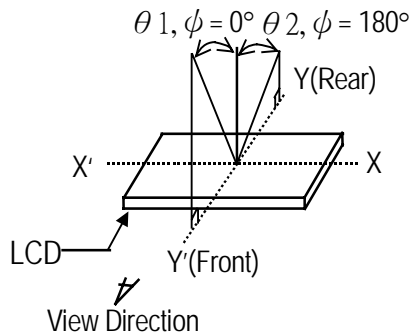

(2) DEFINITION OF CONTRAST

$$C.R = \frac{\text{Brightness of non-selected segment (B2)}}{\text{Brightness of selected segment (B1)}}$$

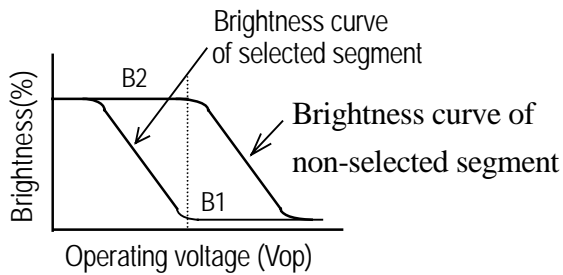

(3) DEFINITION OF RESPONSE

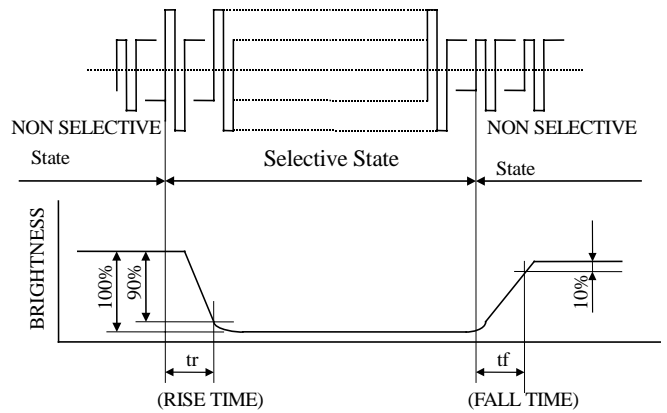

(4) MEASURING INSTRUMENTS FOR ELECTRO-OPTICAL CHARACTERISTICS

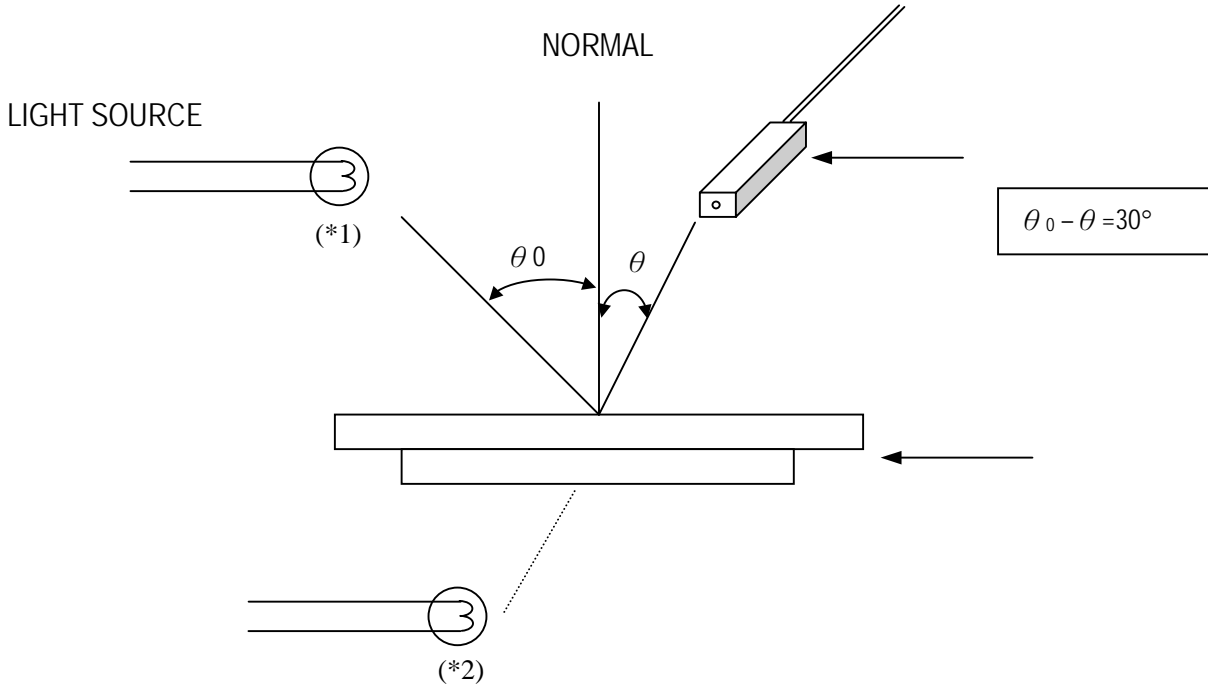

*1. Light source position for measuring the reflective type of LCD panel

*2. Light source position for measuring the transfective / transmissive types of LCD panel

STANDARD DOC.	PRODUCT SPEC.	MODULE NO.	S95160	PAGE	14
------------------	------------------	---------------	--------	------	----

14. ENVIRONMENTAL ABSOLUTE MAXIMUM RATINGS

ITEM	SYMBOL	CONDITIONS	CRITERION
OPERATING TEMPERATURE	TOPR	-20°C ~ +70°C	NO DEFECT IN DISPLAYING AND OPERATIONAL FUNCTION
STORAGE TEMPERATURE	TSTG	-30°C ~ +80°C	NO DEFECT IN DISPLAYING AND OPERATIONAL FUNCTION
HUMIDITY	—	See Note	WITHOUT CONDENSATION

*NOTE: TEST CONDITION

(1) TEMPERATURE AND HUMIDITY: IF NO SPECIFICATION, TEMP. SET AT 25±2°C, HUMIDITY SET AT 60±5%RH

(2) OPERATING STATE: SAMPLES SUBJECT TO THE TESTS SHALL BE IN "OPERATING" CONDITION

15. RELIABILITY TEST

ITEM	CONDITIONS	CRITERION
OPERATING TEMPERATURE	HIGH TEMPERATURE +70°C 240HRS	NO DEFECT IN DISPLAYING AND OPERATIONAL FUNCTION
	LOW TEMPERATURE - 20°C 240HRS	
STORAGE TEMPERATURE	HIGH TEMPERATURE +80°C 240HRS	NO DEFECT IN DISPLAYING AND OPERATIONAL FUNCTION
	LOW TEMPERATURE - 30°C 240HRS	
HUMIDITY	40°C 90%RH 120HRS	NO DEFECT IN DISPLAYING AND OPERATIONAL FUNCTION
VIBRATION	<ul style="list-style-type: none"> • Operating Time: thirty minutes exposure for each direction (X,Y,Z) • Sweep Frequency: 10~55Hz (1 min) • Amplitude: 1.5mm 	NO DEFECT IN DISPLAYING AND OPERATIONAL FUNCTION
THERMAL SHOCK	-20°C (30mins) ←→ +80°C (30mins) 10 cycles	NO DEFECT IN DISPLAYING AND OPERATIONAL FUNCTION

NOTE: The samples must be free from defect before test, must be restore at room condition at least for 2 hour after reliability test before any inspection.

16.THE STANDARD OF INSPECTION

16-1 Inspection items and specification for appearance (power off)

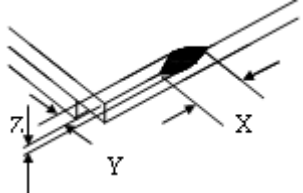
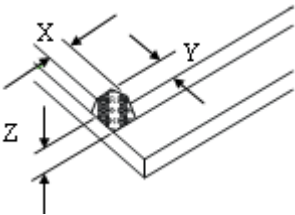
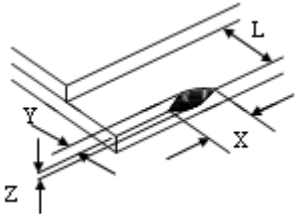
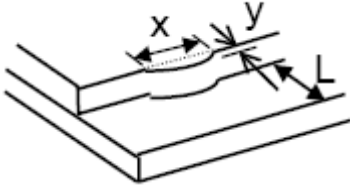
No.	Item	Criterion	AQL																						
1	Dimension	Dimension out of the specification	1.0																						
2	Glass crack	<p>1、 General crack</p>  <table border="1" data-bbox="853 492 1316 616"> <tr> <td>X</td> <td>Y</td> <td>Z</td> </tr> <tr> <td>$\geq K/8$</td> <td>Not over A area</td> <td>$\leq T$</td> </tr> </table> <p>2、 corner</p>  <table border="1" data-bbox="853 739 1316 862"> <tr> <td>X</td> <td>Y</td> <td>Z</td> </tr> <tr> <td>$\geq K/8$</td> <td>Not over A area</td> <td>No check</td> </tr> </table> <p>3、 contact pad crack</p>  <table border="1" data-bbox="853 1041 1316 1164"> <tr> <td>X</td> <td>Y</td> <td>Z</td> </tr> <tr> <td>$\geq K/8$</td> <td>$\geq L/3$</td> <td>No check</td> </tr> </table> <p>4、 Substrate protuberance and internal crack</p>  <table border="1" data-bbox="885 1332 1236 1422"> <tr> <td>X</td> <td>Y</td> </tr> <tr> <td>$\geq K/8$</td> <td>$\geq L/3$</td> </tr> </table> <p>Transfer position crack: $\leq L/5$</p>	X	Y	Z	$\geq K/8$	Not over A area	$\leq T$	X	Y	Z	$\geq K/8$	Not over A area	No check	X	Y	Z	$\geq K/8$	$\geq L/3$	No check	X	Y	$\geq K/8$	$\geq L/3$	2.50
X	Y	Z																							
$\geq K/8$	Not over A area	$\leq T$																							
X	Y	Z																							
$\geq K/8$	Not over A area	No check																							
X	Y	Z																							
$\geq K/8$	$\geq L/3$	No check																							
X	Y																								
$\geq K/8$	$\geq L/3$																								

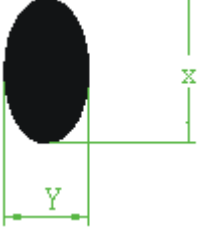
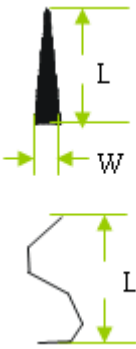
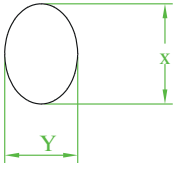
3	Black dot \ White dot	 <p>X: long diameter Y: short diameter D: average of diameter $D=(X+Y)/2$</p>	<table border="1" style="width:100%; border-collapse: collapse;"> <thead> <tr> <th rowspan="2">D</th> <th colspan="2">Acceptable of defect</th> </tr> <tr> <th>A/B Area</th> <th>C Area</th> </tr> </thead> <tbody> <tr> <td>$D < 0.2$</td> <td colspan="2">No check</td> </tr> <tr> <td>$0.2 \leq D < 0.3$</td> <td colspan="2">2</td> </tr> <tr> <td>$0.3 \leq D \leq 0.5$</td> <td colspan="2">1</td> </tr> <tr> <td>$D > 0.5$</td> <td colspan="2">0</td> </tr> </tbody> </table>	D	Acceptable of defect		A/B Area	C Area	$D < 0.2$	No check		$0.2 \leq D < 0.3$	2		$0.3 \leq D \leq 0.5$	1		$D > 0.5$	0		2.50				
D	Acceptable of defect																								
	A/B Area	C Area																							
$D < 0.2$	No check																								
$0.2 \leq D < 0.3$	2																								
$0.3 \leq D \leq 0.5$	1																								
$D > 0.5$	0																								
4	Line defect	 <p>L: Length W: Width Defect of polarizer (Scratches, Spot) : According to the limit specimen</p>	<table border="1" style="width:100%; border-collapse: collapse;"> <thead> <tr> <th rowspan="2">Length</th> <th rowspan="2">Whidth</th> <th colspan="2">Acceptable of defect</th> </tr> <tr> <th>A/B Area</th> <th>C Area</th> </tr> </thead> <tbody> <tr> <td>accept</td> <td>$W \leq 0.02$</td> <td>No check</td> <td rowspan="2">No check</td> </tr> <tr> <td>$L \leq 3$</td> <td>$W \leq 0.05$</td> <td>2</td> </tr> <tr> <td rowspan="2">$L \leq 2.5$</td> <td>$W \leq 0.05$</td> <td>2</td> <td rowspan="2">As round type</td> </tr> <tr> <td>$W > 0.05$</td> <td colspan="2"></td> </tr> </tbody> </table>	Length	Whidth	Acceptable of defect		A/B Area	C Area	accept	$W \leq 0.02$	No check	No check	$L \leq 3$	$W \leq 0.05$	2	$L \leq 2.5$	$W \leq 0.05$	2	As round type	$W > 0.05$			2.50	
Length	Whidth	Acceptable of defect																							
		A/B Area	C Area																						
accept	$W \leq 0.02$	No check	No check																						
$L \leq 3$	$W \leq 0.05$	2																							
$L \leq 2.5$	$W \leq 0.05$	2	As round type																						
	$W > 0.05$																								
5	Polarizer Bubble		<table border="1" style="width:100%; border-collapse: collapse;"> <thead> <tr> <th rowspan="2">D</th> <th colspan="2">Acceptable of defect</th> </tr> <tr> <th>A/B Area</th> <th>C Area</th> </tr> </thead> <tbody> <tr> <td>$D \leq 0.2$</td> <td colspan="2">No check</td> </tr> <tr> <td>$0.2 \leq D \leq 0.5$</td> <td colspan="2">3</td> </tr> <tr> <td>$0.5 \leq D \leq 1.0$</td> <td colspan="2">2</td> </tr> <tr> <td>$D > 1.0$</td> <td colspan="2">0</td> </tr> </tbody> </table>	D	Acceptable of defect		A/B Area	C Area	$D \leq 0.2$	No check		$0.2 \leq D \leq 0.5$	3		$0.5 \leq D \leq 1.0$	2		$D > 1.0$	0		2.50				
D	Acceptable of defect																								
	A/B Area	C Area																							
$D \leq 0.2$	No check																								
$0.2 \leq D \leq 0.5$	3																								
$0.5 \leq D \leq 1.0$	2																								
$D > 1.0$	0																								
6	External print of panel	1、 Transfigure、 pin hole: same as segment transfiguer 2、 Print width: print width $\geq 1/2$ standard width is acceptable		2.50																					
7	Silicon glue	The area of painting silicon glue must cover the ITO circuit.		2.50																					
8	Defect of PCB	1、 The char 、 wrong edition、 bresking off circuit、 crack and air-logged orifice are unreceivable for PCB. 2、 gold finger of PCB can not be oxidative、 smudgy and broken..		2.50																					

STANDARD DOC.	PRODUCT SPEC.	MODULE NO.	S95160	PAGE	17
---------------	---------------	------------	--------	------	----

9	SMT organ	1、 deflexion of component $\leq 1/3$ width of component 2、 Trying to keep dot of soldering tin orbicular 3、 Damage 、 break、 wrong assembly and unseal are unreceivable for component.	2.50
10	Steel Frame	1、 Break and distortion are unreceivable for frame. 2、 If there is one nick which can not lead to cast or hole of painting, we allow that following: Length ≤ 5 mm;Width ≤ 0.3 mm	2.50

16-2 Inspection items and specification for display defect (power on)

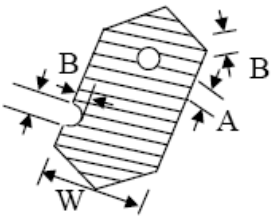
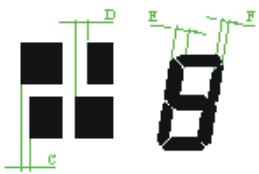
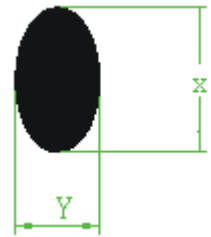
1	Electrical Defect	Segment missing	Not allow	1.0																
		Segment short	Not allow																	
		Non-display	Not allow																	
2	Pin hole	<p>1、 Pin hole</p>  <table border="1" style="margin-left: 20px;"> <tr> <td>width</td> <td>Acceptable of defect</td> </tr> <tr> <td>$W < 0.4$</td> <td>$D \leq 0.2$ & $D \leq 1/2W$</td> </tr> <tr> <td>$W \geq 0.4$</td> <td>$D \leq 0.25$ & $D \leq 1/3W$</td> </tr> </table> <p>* $D = (A+B)/2$ $D \leq 0.1$ acceptable</p>	width	Acceptable of defect	$W < 0.4$	$D \leq 0.2$ & $D \leq 1/2W$	$W \geq 0.4$	$D \leq 0.25$ & $D \leq 1/3W$	2.50											
width	Acceptable of defect																			
$W < 0.4$	$D \leq 0.2$ & $D \leq 1/2W$																			
$W \geq 0.4$	$D \leq 0.25$ & $D \leq 1/3W$																			
3	Display pattern	 <table border="1" style="margin-left: 20px;"> <tr> <td>Width</td> <td>Acceptable of defect</td> </tr> <tr> <td>$W < 0.4$</td> <td>$C, D, G \leq 1/2W$</td> </tr> <tr> <td>$W \geq 0.4$</td> <td>$C, D, G \leq 0.2$</td> </tr> </table> <p>W: Design dimension C、 D: discrepant dimension $G = E-F$</p>	Width	Acceptable of defect	$W < 0.4$	$C, D, G \leq 1/2W$	$W \geq 0.4$	$C, D, G \leq 0.2$	1.0											
Width	Acceptable of defect																			
$W < 0.4$	$C, D, G \leq 1/2W$																			
$W \geq 0.4$	$C, D, G \leq 0.2$																			
4	Black/white dot	 <table border="1" style="margin-left: 20px;"> <tr> <td rowspan="2">D</td> <td colspan="2">Acceptable QTY</td> </tr> <tr> <td>A/B Area</td> <td>C Area</td> </tr> <tr> <td>$D < 0.1$</td> <td colspan="2">No check</td> </tr> <tr> <td>$0.1 \leq D < 0.2$</td> <td colspan="2">2</td> </tr> <tr> <td>$0.2 \leq D \leq 0.25$</td> <td colspan="2">1</td> </tr> <tr> <td>$D > 0.25$</td> <td colspan="2">0</td> </tr> </table> <p>X: long diameter Y: shot diameter D: average diameter $D = (X+Y)/2$</p>	D	Acceptable QTY		A/B Area	C Area	$D < 0.1$	No check		$0.1 \leq D < 0.2$	2		$0.2 \leq D \leq 0.25$	1		$D > 0.25$	0		2.50
D	Acceptable QTY																			
	A/B Area	C Area																		
$D < 0.1$	No check																			
$0.1 \leq D < 0.2$	2																			
$0.2 \leq D \leq 0.25$	1																			
$D > 0.25$	0																			

STANDARD DOC.	PRODUCT SPEC.	MODULE NO.	S95160		PAGE	18
---------------	---------------	------------	--------	--	------	----

5	Line defect	<p>L: length W: width</p>	Length	Width	Acceptable QTY		2.50
			不计	$W \leq 0.02$	No check	C Area	
			$L \leq 3$	$W \leq 0.03$	2	No check	
			$L \leq 2.5$	$0.03 < W \leq 0.05$	2		
		$W > 0.05$		Sa round type			

17.USING LCD MODULES

17-1 LIQUID CRYSTAL DISPLAY MODULES

LCD is composed of glass and polarizer. Pay attention to the following items when handling.

- (1) Please keep the temperature within specified range for use and storage. Polarization degradation, bubble generation or polarizer peel-off may occur with high temperature and high humidity.
- (2) Do not touch, push or rub the exposed polarizers with anything harder than an HB pencil lead (glass, tweezers, etc.).
- (3) N-hexane is recommended for cleaning the adhesives used to attach front/rear polarizers and reflectors made of organic substances which will be damaged by chemicals such as acetone, toluene, ethanol and isopropylalcohol.
- (4) If the display surface becomes contaminated, breathe on the surface and gently wipe it with a soft dry cloth. If it is heavily contaminated, wipe gently with absorbent cotton or other soft material like chamois soaked in Isopropyl alcohol or Ethyl alcohol. Do not scrub hard to avoid damaging the display surface.
- (5) Wipe off saliva or water drops immediately, contact with water over a long period of time may cause deformation or color fading.
- (6) Avoid contacting oil and fats.
- (7) Condensation on the surface and contact with terminals due to cold will damage, stain or dirty the polarizers. After products are tested at low temperature they must be warmed up in a container before coming is contacting with room temperature air.
- (8) Do not put or attach anything on the display area to avoid leaving marks on.
- (9) Do not touch the display with bare hands. This will stain the display area and degradate insulation between terminals (some cosmetics are determinated to the polarizers).
- (10) Exercise care to minimize corrosion of the electrode. Corrosion of the electrodes is accelerated by water droplets, moisture condensation or a current flow in a high-humidity environment.
- (11) As glass is fragile. It tends to become or chipped during handling especially on the edges. Please avoid dropping or jarring.

17-2 PRECAUTION FOR HANDING LCD MODULES

Since LCM has been assembled and adjusted with a high degree of precision, avoid applying excessive shocks to the module or making any alterations or modifications to it.

SUCCESS ELECTRONIC CO.,LTD.

STANDARD DOC.	PRODUCT SPEC.	MODULE NO.	S95160	PAGE	19
--------------------------	--------------------------	-----------------------	---------------	-------------	-----------

- (1) Do not alter, modify or change the the shape of the tab on the metal frame.
- (2) Do not make extra holes on the printed circuit board, modify its shape or change the positions of components to be attached.
- (3) Do not damage or modify the pattern writing on the printed circuit board.
- (4) Absolutely do not modify the zebra rubber strip (conductive rubber) or heat seal connector.
- (5) Except for soldering the interface, do not make any alterations or modifications with a soldering iron.
- (6) Do not drop, bend or twist LCM. In particular, do not forcibly pull or bend the I/O cable or the backlight cable.
- (7) In order to avoid the cracking of the FPC,you should to pay attention to the area of FPC where the FPC was bent .the edge of coverlay;the area of surface of Ni-Au plating,the area of soldering land,the area of through hole.

17-3 ELECTRO-STATIC DISCHARGE CONTROL

Since this module uses a CMOS LSI, the same careful attention should be paid to electrostatic discharge as for an ordinary CMOS IC.

- (1) Make certain that you are grounded when handing LCM. To minimize the performance degradation of the LCD modules resulting from destruction caused by static electricity etc., exercise care to avoid holding the following sections when handling the modules. - Exposed area of the printed circuit board. - Terminal electrode sections.
- (2) Before remove LCM from its packing case or incorporating it into a set, be sure the module and your body have the same electric potential.
- (3) When soldering the terminal of LCM, make certain the AC power source for the soldering iron does not leak.
- (4) When using an electric screwdriver to attach LCM, the screwdriver should be of ground potentiality to minimize as much as possible any transmission of electromagnetic waves produced sparks coming from the commutator of the motor.
- (5) As far as possible make the electric potential of your work clothes and that of the work bench the ground potential.
- (6) To reduce the generation of static electricity be careful that the air in the work is not too dried. A relative humidity of 50%-60% is recommended.

17-4 PRECAUTIONS FOR OPERATION

- (1) Viewing angle varies with the change of liquid crystal driving voltage (VO). Adjust VO to show the best contrast.
- (2) Driving the LCD in the voltage above the limit shortens its life.
- (3) If the LCD modules have been operating for a long time showing the same display patterns, the display patterns may remain on the screen as ghost images and a slight contrast irregularity may also appear. A normal operating status can be regained by suspending use for some time. It should be noted that this phenomenon does not adversely affect performance reliability.
- (4) Response time is greatly delayed at temperature below the operating temperature range. However, this does not mean the LCD will be out of the order. It will recover when it returns to the specified temperature range.
- (5) If the display area is pushed hard during operation, the display will become abnormal. However, it will return to normal if it is turned off and then back on.
- (6) Condensation on terminals can cause an electrochemical reaction disrupting the terminal circuit. Therefore, it must be used under the relative condition of 40°C , 50% RH.
- (7) When turning the power on, input each signal after the positive/negative voltage becomes stable.

STANDARD DOC.	PRODUCT SPEC.	MODULE NO.	S95160	PAGE	20
------------------	------------------	---------------	--------	------	----

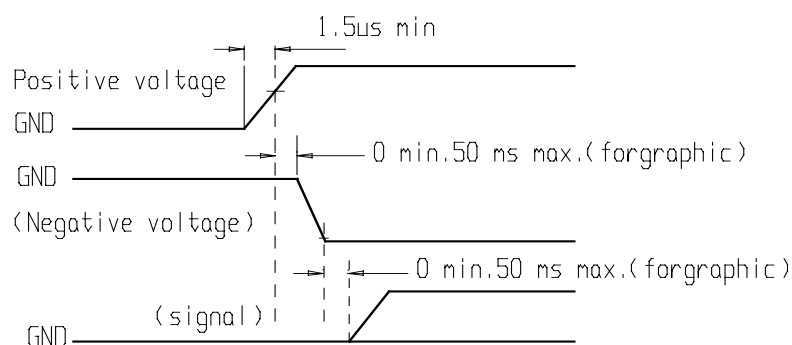

17-5 STORAGE

When storing LCDs as spares for some years, the following precaution are necessary.

- (1) Store them in a sealed polyethylene bag. If properly sealed, there is no need for dessicant.
- (2) Store them in a dark place. Do not expose to sunlight or fluorescent light, keep the temperature between 0°C and 35°C.
- 3) The polarizer surface should not come in contact with any other objects. (We advise you to store them in the container in which they were shipped.)
- (4) Environmental conditions :
 - Do not leave them for more than 160hrs. at 70°C.
 - Should not be left for more than 48hrs. at -20°C.

17-6 SAFETY

- (1) It is recommended to crush damaged or unnecessary LCDs into pieces and wash them off with solvents such as acetone and ethanol, which should later be burned.
- (2) If any liquid leaks out of a damaged glass cell and comes in contact with the hands, wash off thoroughly with soap and water.

17-7 LIMITED WARRANTY

Unless agreed between SUCCESS and customer, SUCCESS will replace or repair any of its LCD modules which are found to be functionally defective when inspected in accordance with SUCCESS LCD acceptance standards (copies available upon request) for a period of one year from date of shipments. Cosmetic/visual defects must be returned to SUCCESS within 90 days of shipment. Confirmation of such date shall be based on freight documents. The warranty liability of SUCCESS limited to repair and/or replacement on the terms set forth above. SUCCESS will not be responsible for any subsequent or consequential events.

17-8 RETURN LCM UNDER WARRANTY

No warranty can be granted if the precautions stated above have been disregarded. The typical examples of violations are :

- Broken LCD glass.
- Circuit modified in any way, including addition of components.

Module repairs will be invoiced to the customer upon mutual agreement. Modules must be returned with sufficient description of the failures or defects. Any connectors or cable installed by the customer must be removed completely without damaging the PCB's eyelet, conductors and terminals.