

MOSFET

CoolSiC™ Power Device 750 V G1

The 750 V CoolSiC™ is built over the solid silicon carbide technology developed in Infineon in more than 20 years. Leveraging the wide bandgap SiC material characteristics, the 750V CoolSiC™ MOSFET offers a unique combination of performance, reliability and ease of use. Suitable for high temperature and harsh operations, it enables the simplified and cost effective deployment of the highest system efficiency.

Features

- Highly robust 750V technology, 100% avalanche tested
- Best-in-class $R_{DS(on)} \times Q_{fr}$
- Excellent $R_{DS(on)} \times Q_{oss}$ and $R_{DS(on)} \times Q_G$
- Unique combination of low C_{rss}/C_{iss} and high $V_{GS(th)}$
- Infineon proprietary die attach technology
- Driver source pin available

Benefits

- Enhanced robustness and reliability for bus voltages beyond 500 V
- Superior efficiency in hard switching
- Higher switching frequency in soft switching topologies
- Robustness against parasitic turn on for unipolar gate driving
- Reduced switching losses through improved gate control

Potential applications

- EV charging infrastructure
- Solar PV inverters
- UPS (uninterruptable power supplies)
- Energy storage and battery formation
- Telecom and Server SMPS

Product validation

Fully qualified according to JEDEC for Industrial Applications

Please note: The source and driver source pins are not exchangeable. Their exchange might lead to malfunction.

Table 1 Key Performance Parameters

Parameter	Value	Unit
V_{DSS} over full $T_{j,range}$	750	V
$R_{DS(on),typ}$	20	mΩ
$R_{DS(on),max}$	27	mΩ
$Q_{G,typ}$	67	nC
$I_{DM,max}$	261	A
$Q_{oss,typ}$ @ 500 V	133	nC
$E_{oss,typ}$ @ 500 V	23.9	μJ

Type / Ordering Code	Package	Marking	Related Links
IMZA75R020M1H	PG-TO247-4	75R020M1	see Appendix A

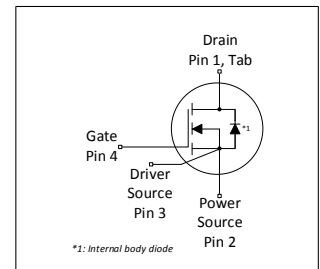
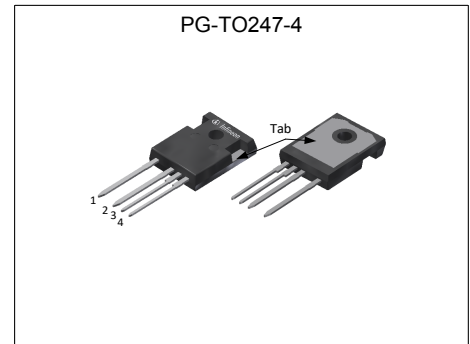

RoHS

Table of Contents

Description	1
Maximum ratings	3
Thermal characteristics	4
Operating range	4
Electrical characteristics	5
Electrical characteristics diagrams	7
Test Circuits	12
Package Outlines	13
Appendix A	14
Revision History	15
Trademarks	15
Disclaimer	15

1 Maximum ratings

at $T_j = 25\text{ °C}$, unless otherwise specified.

Note: for optimum lifetime and reliability, Infineon recommends operating conditions that do not exceed 80% of the maximum ratings stated in this datasheet.

Table 2 Maximum ratings

Parameter	Symbol	Values			Unit	Note / Test Condition
		Min.	Typ.	Max.		
Continuous DC drain current ¹⁾	I_{DCC}	-	-	75 52	A	$T_C = 25\text{ °C}$ $T_C = 100\text{ °C}$
Peak drain current ²⁾	I_{DM}	-	-	261	A	$T_C = 25\text{ °C}$, $V_{\text{GS}} = 18\text{ V}$
Avalanche energy, single pulse	E_{AS}	-	-	333	mJ	$I_{\text{D}} = 12.5\text{ A}$, $V_{\text{DD}} = 50\text{ V}$; see table 11
Avalanche energy, repetitive pulse	E_{AR}	-	-	1.66	mJ	$I_{\text{D}} = 12.5\text{ A}$, $V_{\text{DD}} = 50\text{ V}$; see table 11
Avalanche current, single pulse	I_{AS}	-	-	12.5	A	-
MOSFET dv/dt ruggedness	dv/dt	-	-	200	V/ns	$V_{\text{DS}} = 0\text{...}500\text{ V}$
Gate source voltage (static)	V_{GS}	-5	-	23	V	-
Gate source voltage (transient)	V_{GS}	-10	-	25	V	$t_p \leq 500\text{ ns}$, duty cycle $\leq 1\%$
Power dissipation	P_{tot}	-	-	278	W	$T_C = 25\text{ °C}$
Storage temperature	T_{stg}	-55	-	150	°C	-
Operating junction temperature	T_j	-55	-	175	°C	-
Mounting torque	-	-	-	60	Ncm	M3 and M3.5 screws
Continuous reverse drain current ¹⁾	I_{SDC}	-	-	75 50	A	$V_{\text{GS}} = 18\text{ V}$, $T_C = 25\text{ °C}$ $V_{\text{GS}} = 0\text{ V}$, $T_C = 25\text{ °C}$
Peak reverse drain current ²⁾	I_{SM}	-	-	261 83	A	$T_C = 25\text{ °C}$, $t_p \leq 250\text{ ns}$ $T_C = 25\text{ °C}$
Insulation withstand voltage	V_{ISO}	-	-	n.a.	V	V_{rms} , $T_C = 25\text{ °C}$, $t = 1\text{ min}$

¹⁾ Limited by $T_{j,\text{max}}$

²⁾ Pulse width t_p limited by $T_{j,\text{max}}$

2 Thermal characteristics

Table 3 Thermal characteristics

Parameter	Symbol	Values			Unit	Note / Test Condition
		Min.	Typ.	Max.		
Thermal resistance, junction - case	$R_{th(j-c)}$	-	-	0.54	°C/W	Not subject to production test. Parameter verified by design/characterization according to JESD51-14.
Soldering temperature, wave soldering only allowed at leads	T_{sold}	-	-	260	°C	1.6mm (0.063 in.) from case for 10s

3 Operating range

Table 4 Operating range

Parameter	Symbol	Values			Unit	Note / Test Condition
		Min.	Typ.	Max.		
Gate-source voltage operating range including undershoots ¹⁾	V_{GS}	-2	-	20	V	-
Recommended turn-on voltage	$V_{GS(on)}$	-	18	-	V	-
Recommended turn-off voltage	$V_{GS(off)}$	-	0	-	V	-

¹⁾ **Important notice:** If the gate source voltage of the device in application exceeds the operating range (Table 4), the device $R_{DS(on)}$ and $V_{GS(th)}$ might exceed the maximum value stated in the datasheet at the end of the lifetime of the device. In order to ensure sound operation of the device over the planned lifetime, the maximum ratings (Table 2) and the application note AN2018-09 must be considered.

4 Electrical characteristics

at $T_j = 25\text{ °C}$, unless otherwise specified

Table 5 Static characteristics

Parameter	Symbol	Values			Unit	Note / Test Condition
		Min.	Typ.	Max.		
Drain-source voltage ¹⁾	V_{DSS}	750	-	-	V	$V_{GS} = 0\text{ V}$, $I_D = 1.17\text{ mA}$, $T_j = -55\text{ °C to }175\text{ °C}$
Gate threshold voltage ²⁾	$V_{GS(th)}$	3.5	4.3	5.6	V	$V_{DS} = V_{GS}$, $I_D = 11.7\text{ mA}$
Zero gate voltage drain current	I_{DSS}	-	1 10	75 -	μA	$V_{DS} = 750\text{ V}$, $V_{GS} = 0\text{ V}$, $T_j = 25\text{ °C}$ $V_{DS} = 750\text{ V}$, $V_{GS} = 0\text{ V}$, $T_j = 175\text{ °C}$
Gate-source leakage current	I_{GSS}	-	-	100	nA	$V_{GS} = 20\text{ V}$, $V_{DS} = 0\text{ V}$
Drain-source on-state resistance	$R_{DS(on)}$	-	25 20 18 36	- 27 -	m Ω	$V_{GS} = 15\text{ V}$, $I_D = 32.5\text{ A}$, $T_j = 25\text{ °C}$ $V_{GS} = 18\text{ V}$, $I_D = 32.5\text{ A}$, $T_j = 25\text{ °C}$ $V_{GS} = 20\text{ V}$, $I_D = 32.5\text{ A}$, $T_j = 25\text{ °C}$ $V_{GS} = 18\text{ V}$, $I_D = 32.5\text{ A}$, $T_j = 175\text{ °C}$
Internal gate resistance	$R_{G,int}$	-	3	-	Ω	$f = 1\text{ MHz}$

Table 6 Dynamic characteristics

External parasitic elements (PCB layout) influence switching behavior significantly.

Stray inductances and coupling capacitances must be minimized.

For layout recommendations please use provided application notes or contact Infineon sales office.

Parameter	Symbol	Values			Unit	Note / Test Condition
		Min.	Typ.	Max.		
Input capacitance	C_{iss}	-	2217	-	pF	$V_{GS} = 0\text{ V}$, $V_{DS} = 500\text{ V}$, $f = 250\text{ kHz}$
Reverse transfer capacitance	C_{riss}	-	14	-	pF	$V_{GS} = 0\text{ V}$, $V_{DS} = 500\text{ V}$, $f = 250\text{ kHz}$
Output capacitance ³⁾	C_{oss}	-	149	193	pF	$V_{GS} = 0\text{ V}$, $V_{DS} = 500\text{ V}$, $f = 250\text{ kHz}$
Output charge ³⁾	Q_{oss}	-	133	173	nC	calculation based on C_{oss}
Effective output capacitance, energy related ⁴⁾	$C_{o(er)}$	-	191	-	pF	$V_{GS} = 0\text{ V}$, $V_{DS} = 0\text{...}500\text{ V}$
Effective output capacitance, time related ⁵⁾	$C_{o(tr)}$	-	267	-	pF	$I_D = \text{constant}$, $V_{GS} = 0\text{ V}$, $V_{DS} = 0\text{...}500\text{ V}$
Turn-on delay time	$t_{d(on)}$	-	13	-	ns	$V_{DD} = 500\text{ V}$, $V_{GS} = 18\text{ V}$, $I_D = 32.5\text{ A}$, $R_G = 1.8\text{ }\Omega$; see table 10
Rise time	t_r	-	15	-	ns	$V_{DD} = 500\text{ V}$, $V_{GS} = 18\text{ V}$, $I_D = 32.5\text{ A}$, $R_G = 1.8\text{ }\Omega$; see table 10
Turn-off delay time	$t_{d(off)}$	-	29	-	ns	$V_{DD} = 500\text{ V}$, $V_{GS} = 18\text{ V}$, $I_D = 32.5\text{ A}$, $R_G = 1.8\text{ }\Omega$; see table 10
Fall time	t_f	-	9	-	ns	$V_{DD} = 500\text{ V}$, $V_{GS} = 18\text{ V}$, $I_D = 32.5\text{ A}$, $R_G = 1.8\text{ }\Omega$; see table 10

¹⁾ Tested at $T_j = 25\text{ °C}$, minimum V_{DSS} verified by design over full junction temperature range.

²⁾ Tested after 1 ms pulse at $V_{GS} = +20\text{ V}$. "Linear mode" operation is not recommended. For assessment of potential "linear mode" operation, please contact Infineon sales office.

³⁾ Maximum specification is defined by calculated six sigma upper confidence bound.

⁴⁾ $C_{o(er)}$ is a fixed capacitance that gives the same stored energy as C_{oss} while V_{DS} is rising from 0 to 500 V.

⁵⁾ $C_{o(tr)}$ is a fixed capacitance that gives the same charging time as C_{oss} while V_{DS} is rising from 0 to 500 V.

Table 7 Gate charge characteristics

Parameter	Symbol	Values			Unit	Note / Test Condition
		Min.	Typ.	Max.		
Plateau gate to source charge	$Q_{GS(pl)}$	-	18	-	nC	$V_{DD} = 500\text{ V}$, $I_D = 32.5\text{ A}$, $V_{GS} = 0\text{ to }18\text{ V}$
Gate to drain charge	Q_{GD}	-	17	-	nC	$V_{DD} = 500\text{ V}$, $I_D = 32.5\text{ A}$, $V_{GS} = 0\text{ to }18\text{ V}$
Total gate charge	Q_G	-	67	-	nC	$V_{DD} = 500\text{ V}$, $I_D = 32.5\text{ A}$, $V_{GS} = 0\text{ to }18\text{ V}$

Table 8 Reverse diode characteristics

Parameter	Symbol	Values			Unit	Note / Test Condition
		Min.	Typ.	Max.		
Drain-source reverse voltage	V_{SD}	-	3.9	5.3	V	$V_{GS} = 0\text{ V}$, $I_S = 32.5\text{ A}$, $T_j = 25\text{ °C}$
MOSFET forward recovery time	t_{fr}	-	23 15	-	ns	$V_{DD} = 500\text{ V}$, $I_S = 32.5\text{ A}$, $di_S/dt = 1000\text{ A}/\mu\text{s}$; see table 9 $V_{DD} = 500\text{ V}$, $I_S = 32.5\text{ A}$, $di_S/dt = 4000\text{ A}/\mu\text{s}$; see table 9
MOSFET forward recovery charge ¹⁾	Q_{fr}	-	135 212	-	nC	$V_{DD} = 500\text{ V}$, $I_S = 32.5\text{ A}$, $di_S/dt = 1000\text{ A}/\mu\text{s}$; see table 9 $V_{DD} = 500\text{ V}$, $I_S = 32.5\text{ A}$, $di_S/dt = 4000\text{ A}/\mu\text{s}$; see table 9
MOSFET peak forward recovery current	I_{frm}	-	12 29	-	A	$V_{DD} = 500\text{ V}$, $I_S = 32.5\text{ A}$, $di_S/dt = 1000\text{ A}/\mu\text{s}$; see table 9 $V_{DD} = 500\text{ V}$, $I_S = 32.5\text{ A}$, $di_S/dt = 4000\text{ A}/\mu\text{s}$; see table 9

¹⁾ Q_{fr} includes Q_{oss}

5 Electrical characteristics diagrams

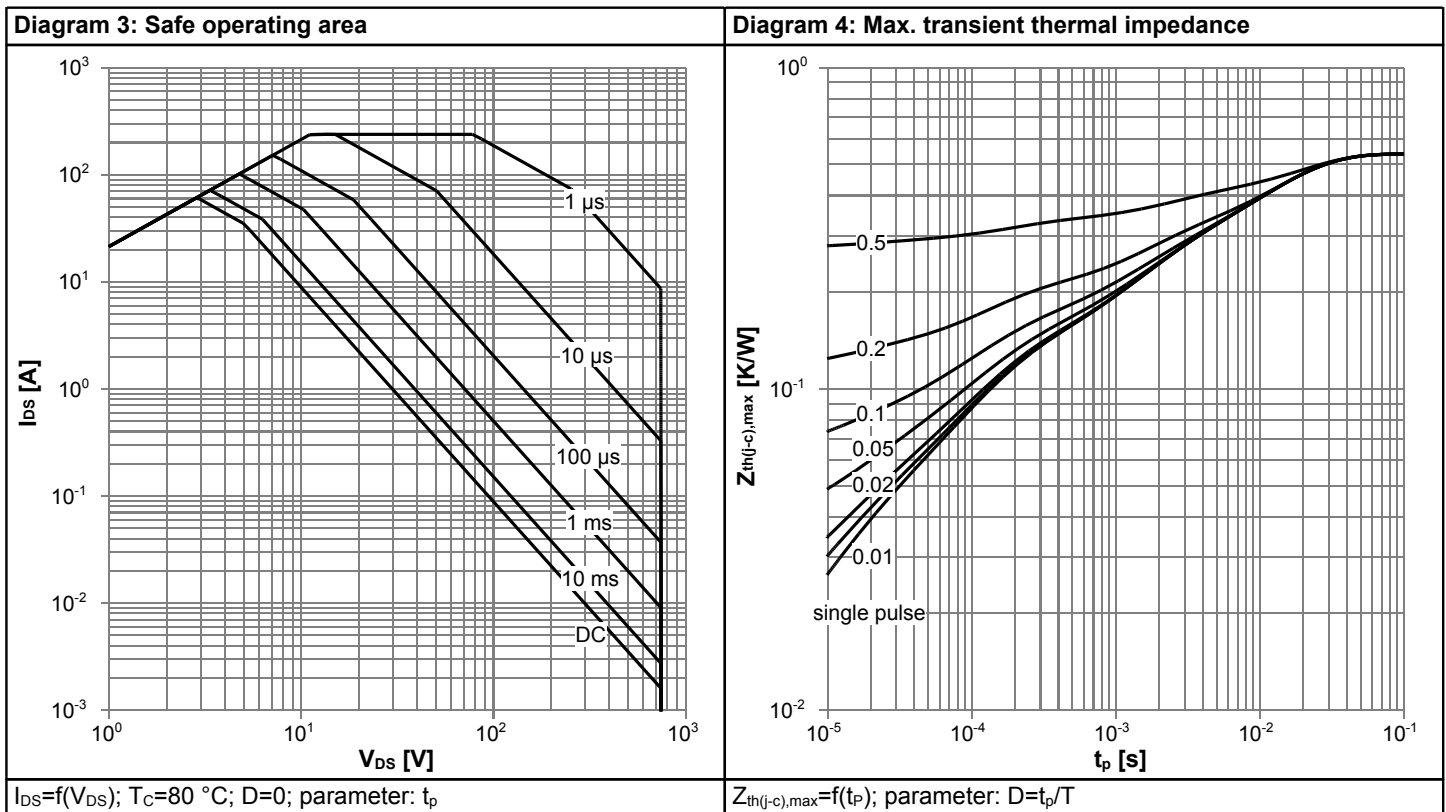
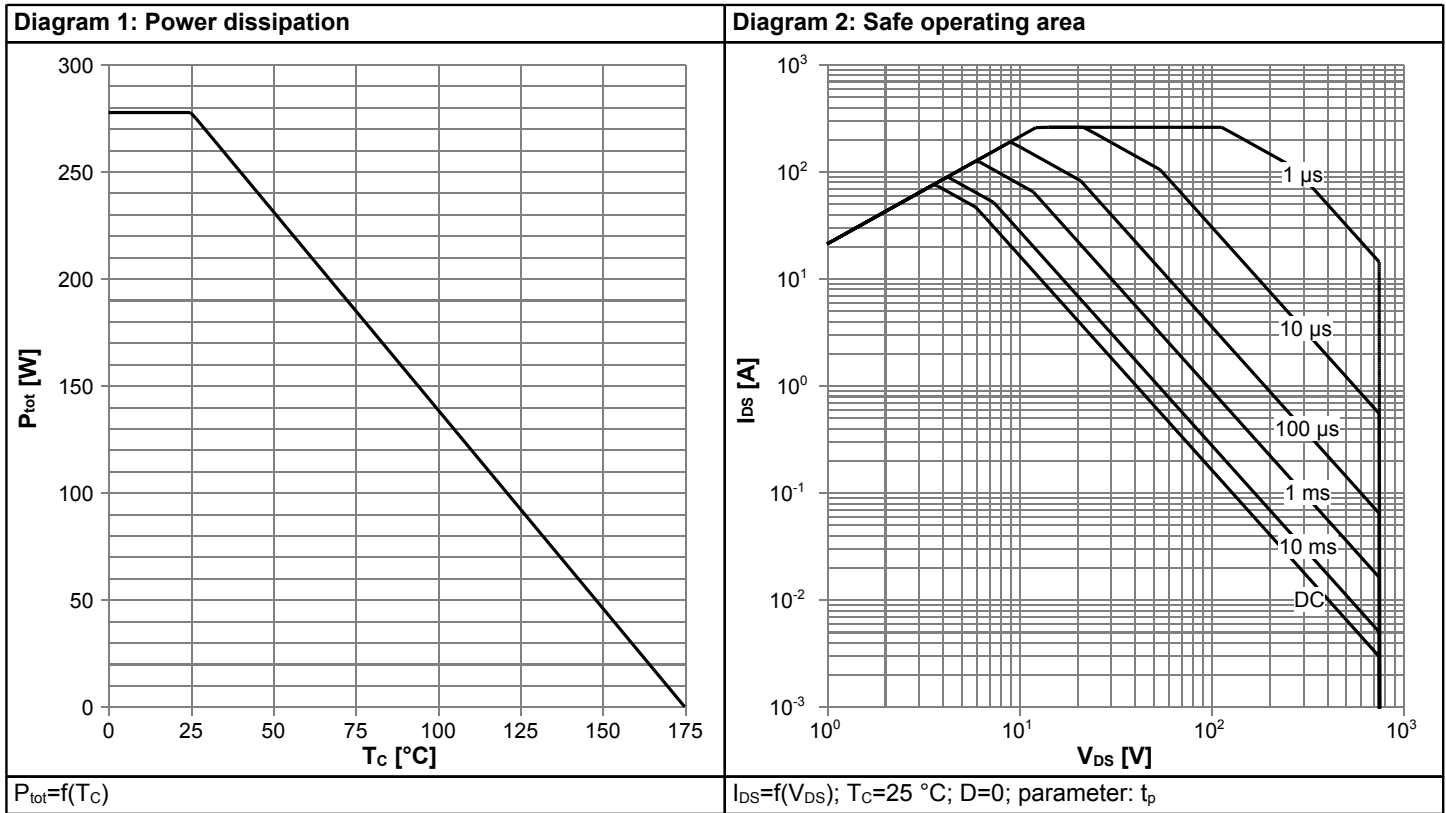
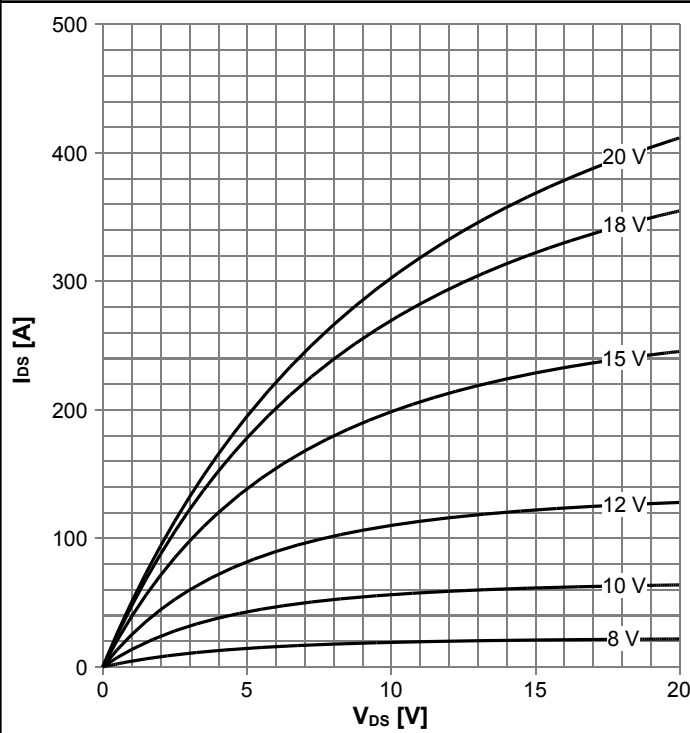
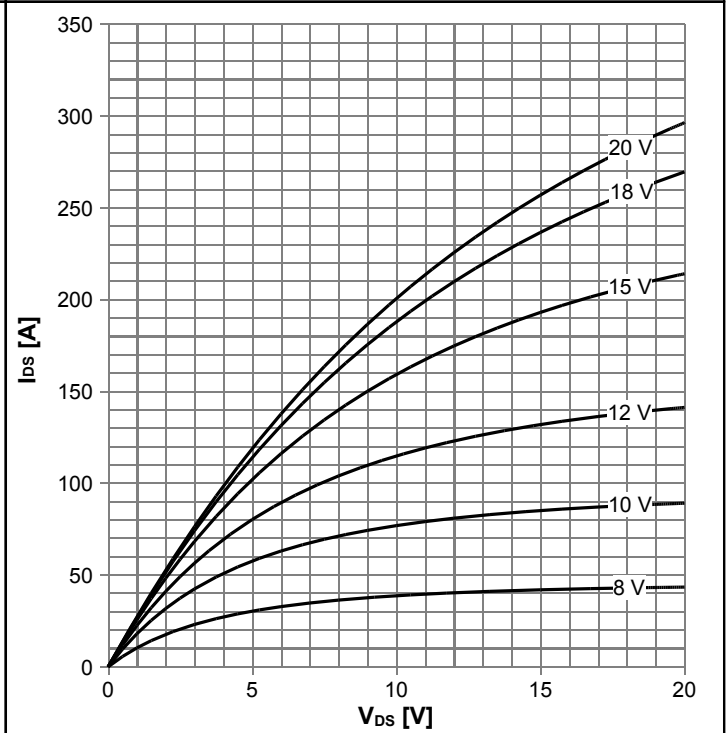

Diagram 5: Typ. output characteristics



$I_{DS}=f(V_{DS}); T_j=25\text{ °C}; \text{parameter: } V_{GS}$

Diagram 6: Typ. output characteristics



$I_{DS}=f(V_{DS}); T_j=175\text{ °C}; \text{parameter: } V_{GS}$

Diagram 7: Typ. drain-source on-state resistance

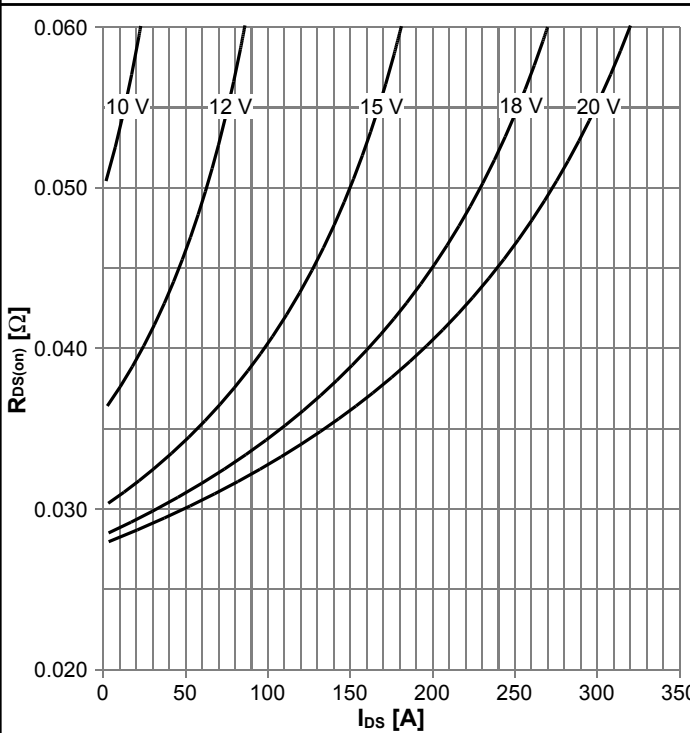

$R_{DS(on)}=f(I_{DS}); T_j=125\text{ °C}; \text{parameter: } V_{GS}$

Diagram 8: Drain-source on-state resistance

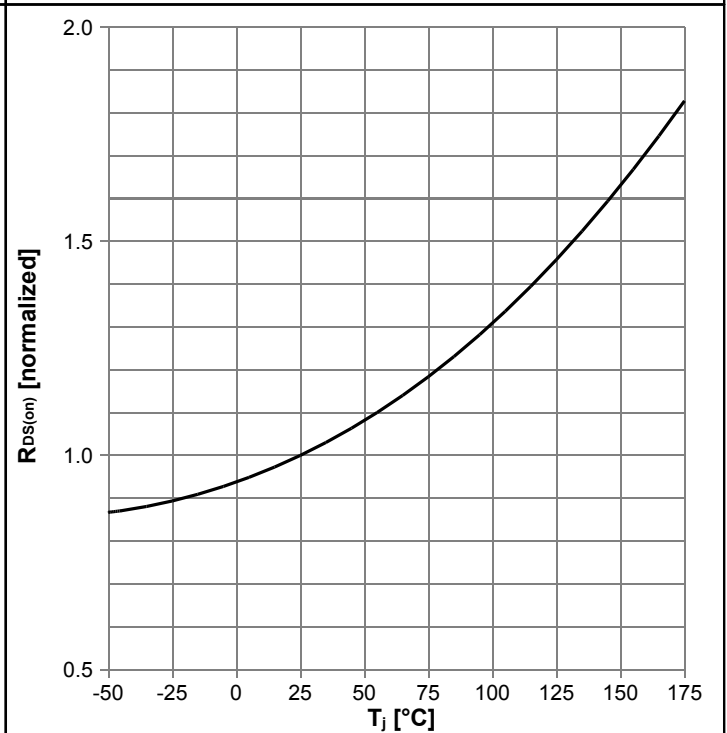

$R_{DS(on)}=f(T_j); I_D=32.5\text{ A}; V_{GS}=18\text{ V}$

Diagram 9: Typ. transfer characteristics

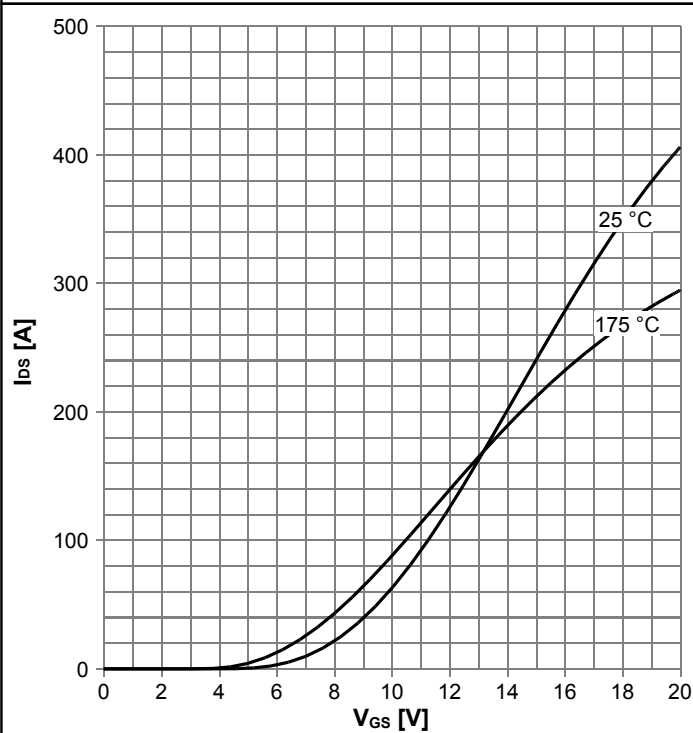

$I_{DS}=f(V_{GS}); V_{DS}=20\text{ V}; \text{parameter: } T_j$

Diagram 10: Typ. gate charge

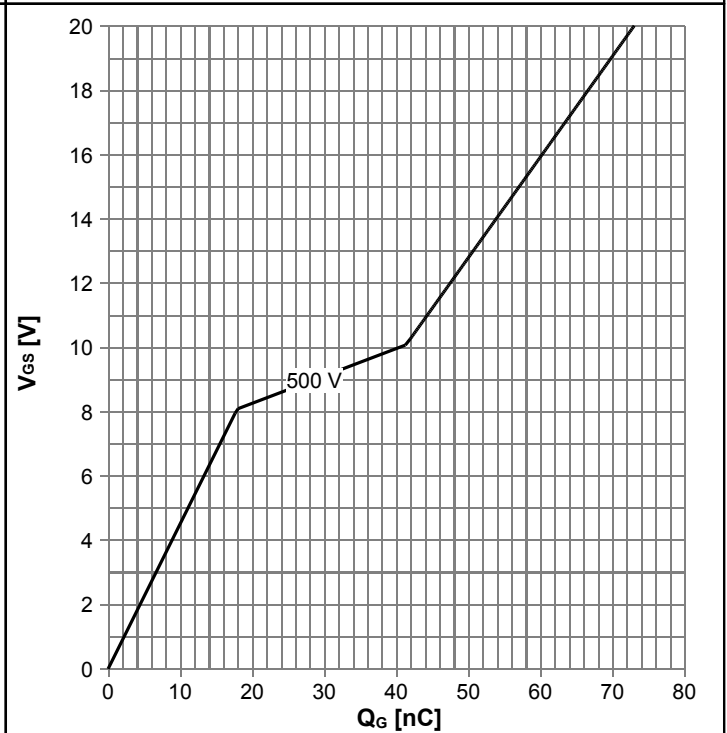

$V_{GS}=f(Q_G); I_D=32.5\text{ A pulsed}; \text{parameter: } V_{DD}$

Diagram 11: Typ. reverse drain current characteristics

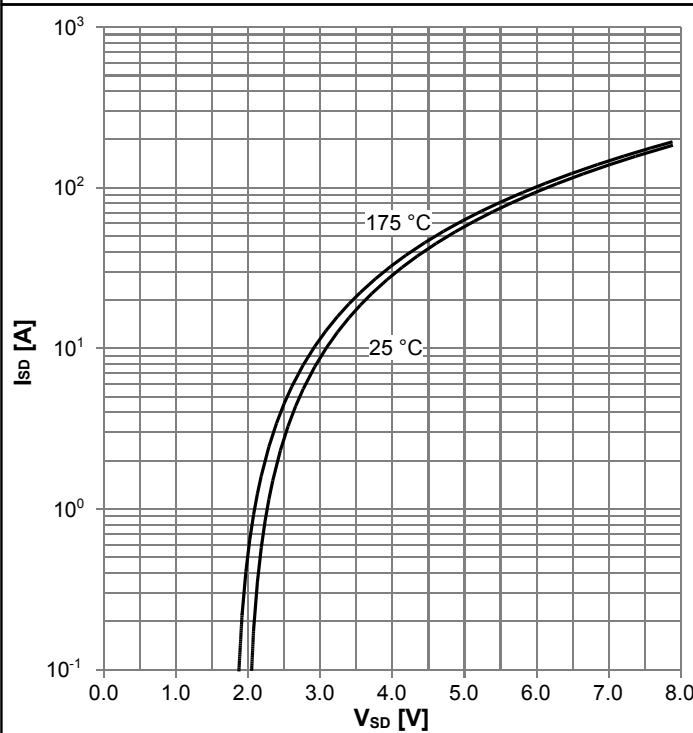

$I_{SD}=f(V_{SD}); V_{GS}=0\text{ V}; \text{parameter: } T_j$

Diagram 12: Typ. reverse drain current characteristics

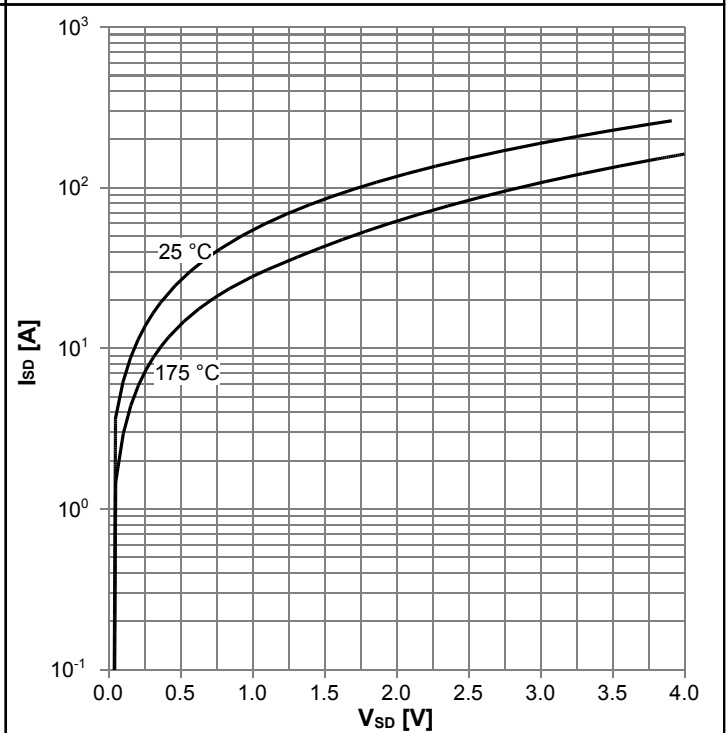

$I_{SD}=f(V_{SD}); V_{GS}=18\text{ V}; \text{parameter: } T_j$

Diagram 13: Avalanche energy

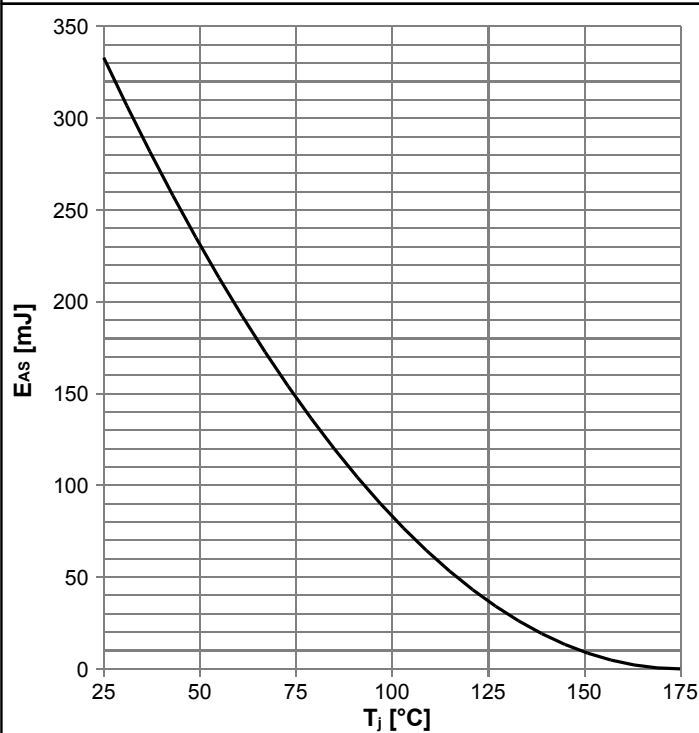

$E_{AS}=f(T_j)$; $I_D=12.5$ A; $V_{DD}=50$ V

Diagram 14: Drain-source breakdown voltage

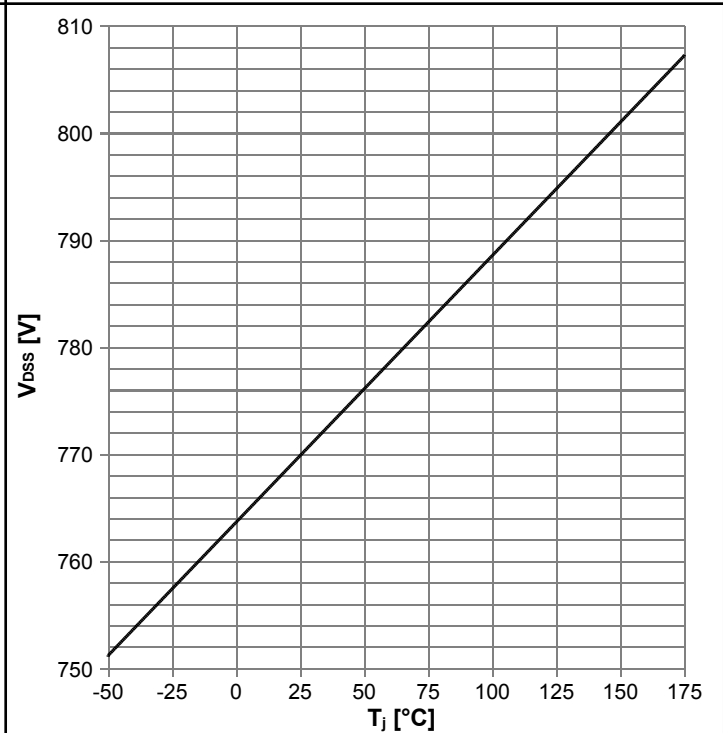

$V_{DSS}=f(T_j)$; $I_D=1.17$ mA

Diagram 15: Typ. capacitances

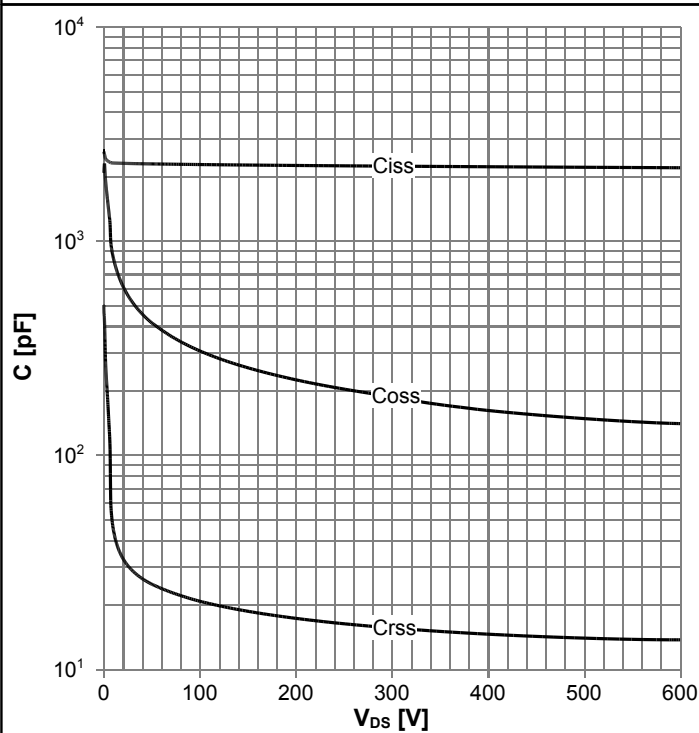

$C=f(V_{DS})$; $V_{GS}=0$ V; $f=250$ kHz

Diagram 16: Typ. Coss stored energy

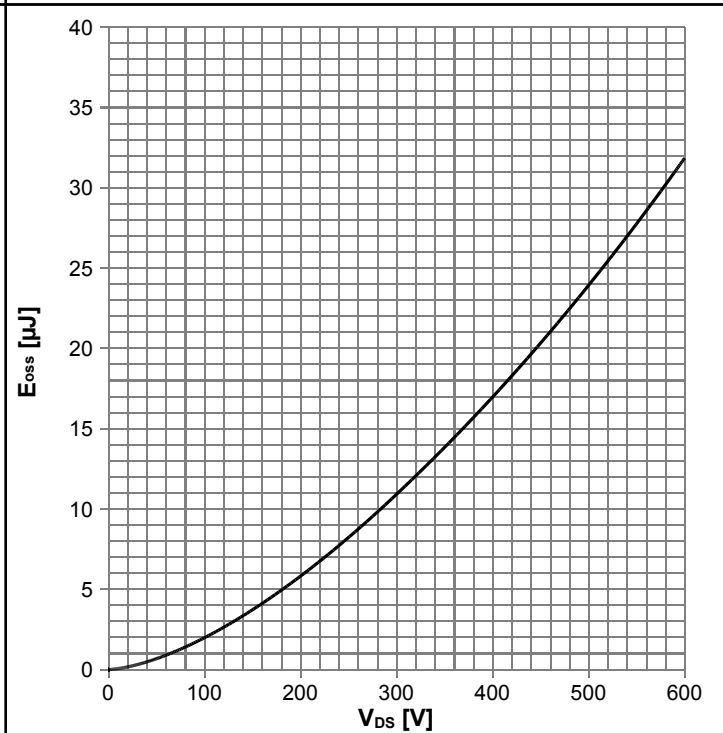

$E_{oss}=f(V_{DS})$

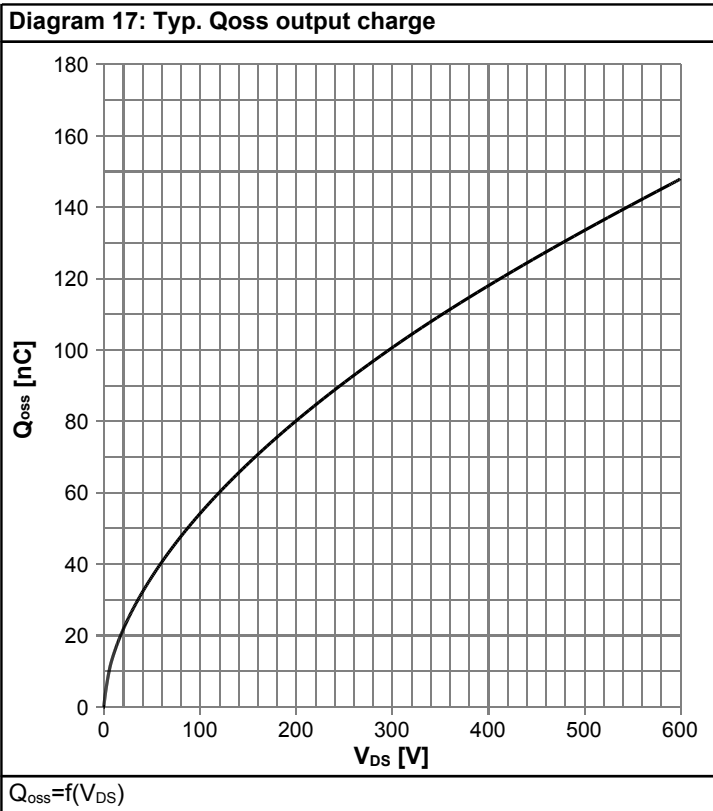

6 Test Circuits

Table 9 Body diode characteristics

Test circuit for body diode characteristics	Body diode recovery waveform

Table 10 Switching times

Switching times test circuit for inductive load	Switching times waveform

Table 11 Unclamped inductive load

Unclamped inductive load test circuit	Unclamped inductive waveform

7 Package Outlines

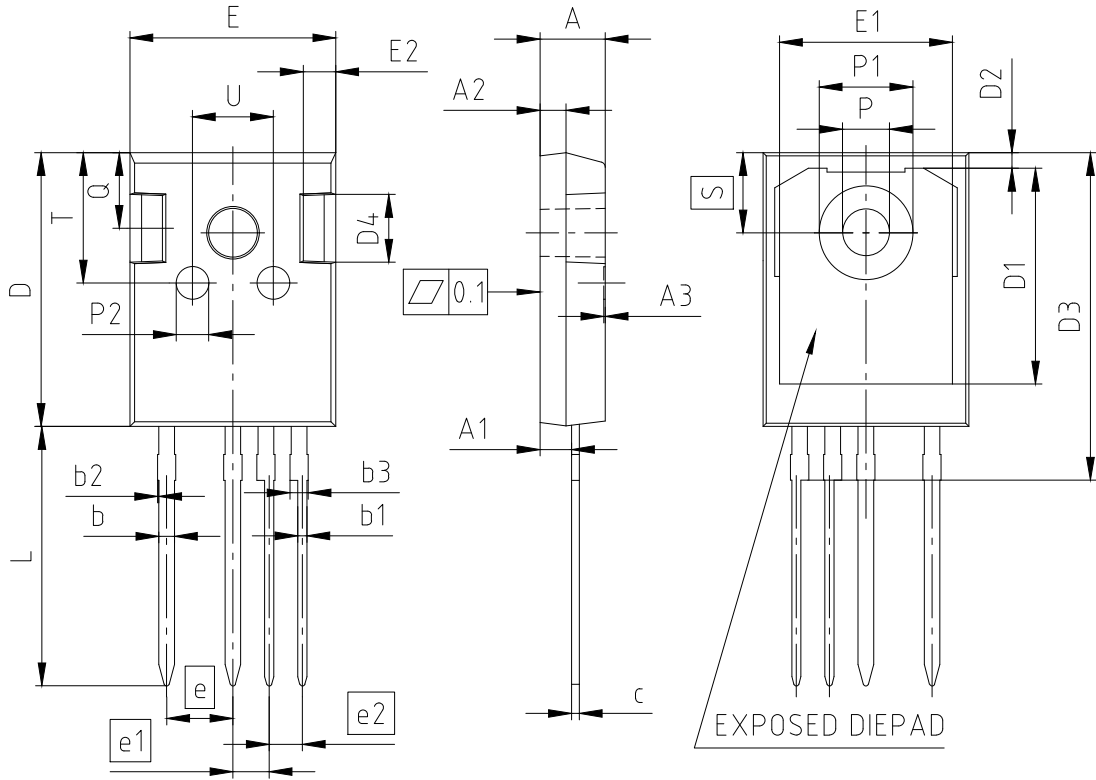

NOTES:
DIMENSIONS DO NOT INCLUDE MOLD FLASH, PROTRUSION OR GATE BURRS

PACKAGE - GROUP NUMBER:		PG-T0247-4-U02			
DIMENSIONS	MILLIMETERS		DIMENSIONS	MILLIMETERS	
	MIN.	MAX.		MIN.	MAX.
A	4.90	5.10	E	15.70	15.90
A1	2.31	2.51	E1	13.10	13.50
A2	1.90	2.10	E2	2.40	2.60
A3	0.05	0.25	e	5.08	
b	1.10	1.30	e1	2.79	
b1	0.65	0.79	e2	2.54	
b2	---	0.20	N	4	
b3	1.34	1.44	L	19.80	20.10
c	0.58	0.66	øP	3.50	3.70
D	20.90	21.10	øP1	7.00	7.40
D1	16.25	16.85	øP2	2.40	2.60
D2	1.05	1.35	Q	5.60	6.00
D3	24.97	25.27	S	6.15	
D4	4.90	5.10	T	9.80	10.20
			U	6.00	6.40

Figure 1 Outline PG-T0247-4, dimensions in mm

8 Appendix A

Table 12 Related Links

- **IFX CoolSiC™ Power Device 750 V G1 Webpage:** www.infineon.com
- **IFX CoolSiC™ Power Device 750 V G1 application note:** www.infineon.com
- **IFX CoolSiC™ Power Device 750 V G1 simulation model:** www.infineon.com
- **IFX Design tools:** www.infineon.com

Revision History

IMZA75R020M1H

Revision: 2024-01-30, Rev. 2.0

Previous Revision

Revision	Date	Subjects (major changes since last revision)
2.0	2024-01-30	Release of final version

Trademarks

All referenced product or service names and trademarks are the property of their respective owners.

We Listen to Your Comments

Any information within this document that you feel is wrong, unclear or missing at all? Your feedback will help us to continuously improve the quality of this document. Please send your proposal (including a reference to this document) to:

erratum@infineon.com

Published by

Infineon Technologies AG
81726 München, Germany
© 2023 Infineon Technologies AG
All Rights Reserved.

Legal Disclaimer

The information given in this document shall in no event be regarded as a guarantee of conditions or characteristics ("Beschaffungsgarantie").

With respect to any examples, hints or any typical values stated herein and/or any information regarding the application of the product, Infineon Technologies hereby disclaims any and all warranties and liabilities of any kind, including without limitation warranties of non-infringement of intellectual property rights of any third party.

In addition, any information given in this document is subject to customer's compliance with its obligations stated in this document and any applicable legal requirements, norms and standards concerning customer's products and any use of the product of Infineon Technologies in customer's applications.

The data contained in this document is exclusively intended for technically trained staff. It is the responsibility of customer's technical departments to evaluate the suitability of the product for the intended application and the completeness of the product information given in this document with respect to such application.

Information

For further information on technology, delivery terms and conditions and prices please contact your nearest Infineon Technologies Office (www.infineon.com).

Warnings

Due to technical requirements, components may contain dangerous substances. For information on the types in question, please contact the nearest Infineon Technologies Office.

The Infineon Technologies component described in this Data Sheet may be used in life-support devices or systems and/or automotive, aviation and aerospace applications or systems only with the express written approval of Infineon Technologies, if a failure of such components can reasonably be expected to cause the failure of that life-support, automotive, aviation and aerospace device or system or to affect the safety or effectiveness of that device or system. Life support devices or systems are intended to be implanted in the human body or to support and/or maintain and sustain and/or protect human life. If they fail, it is reasonable to assume that the health of the user or other persons may be endangered.