

Timing Circuit

IN556

The IN556N/D monolithic timing circuit is a highly stable controller capable of producing accurate time delays, or oscillation.

- Timing From Microseconds Through Hours
- Operates in Both Astable and Monostable Modes
- High Current Output Can Source or Sink 200 mA

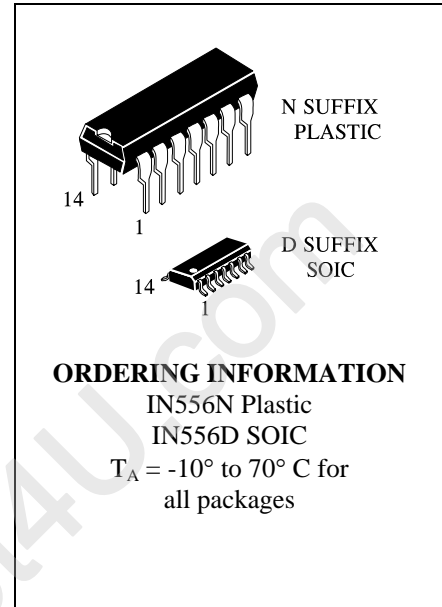

PIN ASSIGNMENT

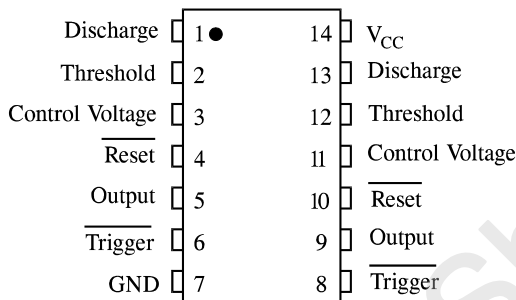

LOGIC DIAGRAM

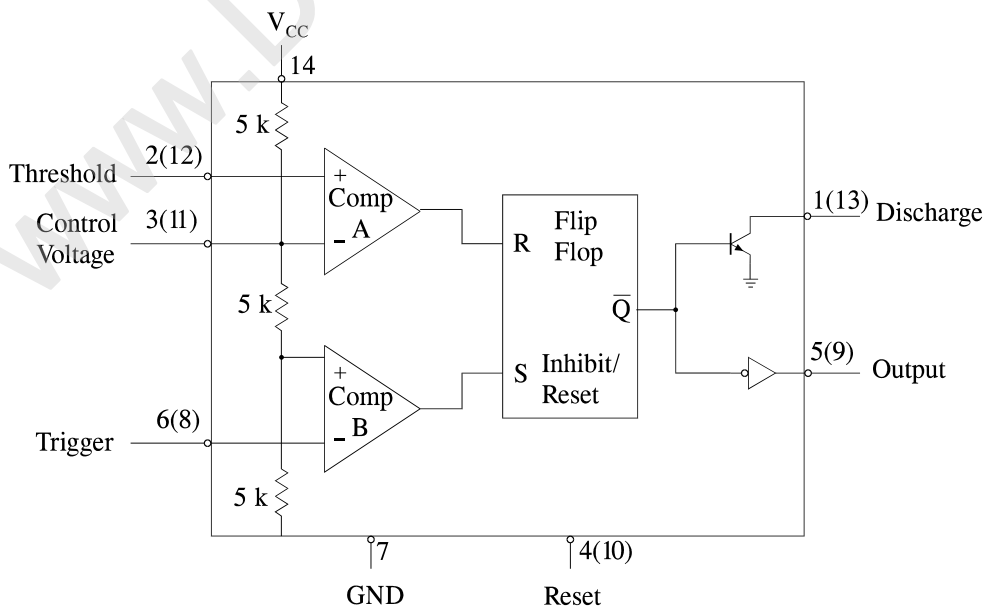

MAXIMUM RATINGS*

Symbol	Parameter	Value	Unit
V _{CC}	Supply Voltage	18	V
T _{stg}	Storage Temperature	-60 to +85	°C

RECOMMENDED OPERATING CONDITIONS

Symbol	Parameter	Min	Max	Unit
V _{CC}	Supply Voltage	4.5	16	V
T _A	Operating Temperature, All Package Types	-10	+70	°C

ELECTRICAL CHARACTERISTICS(T_A =+25°C)

Symbol	Parameter	Test Conditions	Guaranteed Limits		Unit
			Min	Max	
I _{CC}	Supply Current	V _{CC} =5.0 V, R _L =∞ V _{CC} =15 V, R _L =∞		12 30	mA
	Timing Error	R=1.0 kΩ to 100 kΩ Initial Accuracy C = 0.1 μF V _{CC} =5.0 V and V _{CC} =15 V		4	%
V _{th}	Threshold Voltage	V _{CC} =5.0 V V _{CC} =15 V	2.6 9	4.0 11	V
V _T	Trigger Voltage	V _{CC} =5.0 V V _{CC} =15 V	1.1 4.5	2.2 5.6	V
I _T	Trigger Current	V _{06,08} =0 V, V _{CC} =15 V		-2	μA
V _R	Reset Voltage	V _{CC} =15 V	0.4	1.0	V
I _R	Reset Current	V _{04,10} =0 V, V _{CC} =15 V		-0.6	mA
I _{th}	Threshold Current (Note 1)	V _{02,12} =10 V, V _{CC} =15 V		0.25	μA
I _{dis}	Discharge Leakage Current	V _{CC} =15 V, V _{01,13} =15 V		100	nA
V _{REF}	Control Voltage Level	V _{CC} =15 V V _{CC} =5.0 V	9.0 2.6	11 4.0	V
V _{OL}	Output Voltage Low	(V _{CC} =15 V) I _{sink} =10 mA, I _{sink} =50 mA, I _{sink} =100 mA, V _{CC} =5.0 V, I _{sink} =5.0 mA		0.25 0.75 2.3 0.35	V
V _{OH}	Output Voltage High	I _{source} =200 mA, V _{CC} =15 V I _{source} =100 mA, V _{CC} =15 V I _{source} =100 mA, V _{CC} =5.0 V	12 12.75 2.75		V
t _{OLH}	Rise Time of Output	V _{CC} =15 V		300	ns
t _{OHL}	Fall Time of Output	V _{CC} =15 V		300	ns

Note 1. This will determine the maximum value of R_A + R_B for 15 V operation.
The maximum total R=20 MΩ.

**N SUFFIX PLASTIC DIP
(MS - 001AA)**

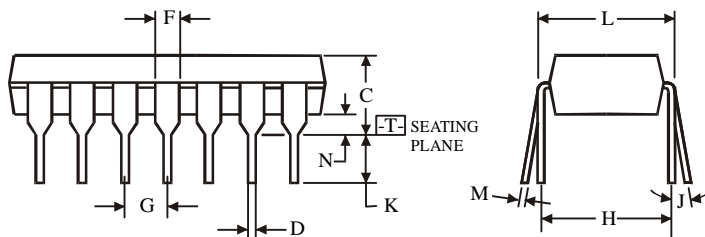
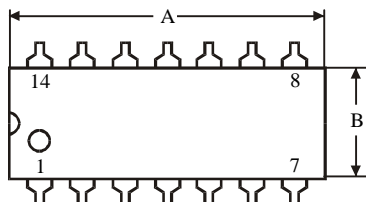
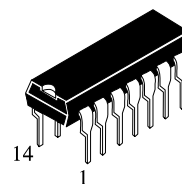

$\oplus 0.25 (0.010) \text{ (M) T}$

NOTES:

- Dimensions "A", "B" do not include mold flash or protrusions.
Maximum mold flash or protrusions 0.25 mm (0.010) per side.

Symbol	Dimension, mm	
	MIN	MAX
A	18.67	19.69
B	6.1	7.11
C		5.33
D	0.36	0.56
F	1.14	1.78
G	2.54	
H	7.62	
J	0°	10°
K	2.92	3.81
L	7.62	8.26
M	0.2	0.36
N	0.38	

**D SUFFIX SOIC
(MS - 012AB)**

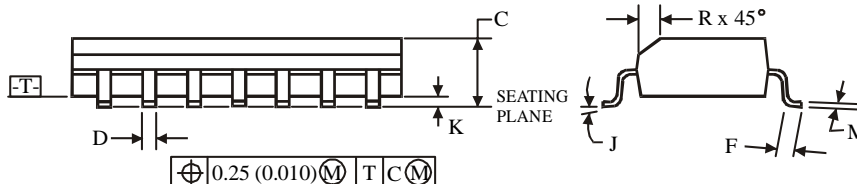
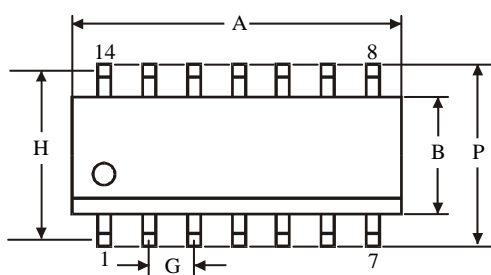
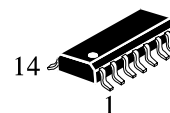

$\oplus 0.25 (0.010) \text{ (M) T C (M)}$

NOTES:

- Dimensions A and B do not include mold flash or protrusion.
- Maximum mold flash or protrusion 0.15 mm (0.006) per side for A; for B - 0.25 mm (0.010) per side.

Symbol	Dimension, mm	
	MIN	MAX
A	8.55	8.75
B	3.8	4
C	1.35	1.75
D	0.33	0.51
F	0.4	1.27
G	1.27	
H	5.27	
J	0°	8°
K	0.1	0.25
M	0.19	0.25
P	5.8	6.2
R	0.25	0.5