

IN7407

Hex Buffers/Drivers with Open-Collector High-Voltage Outputs

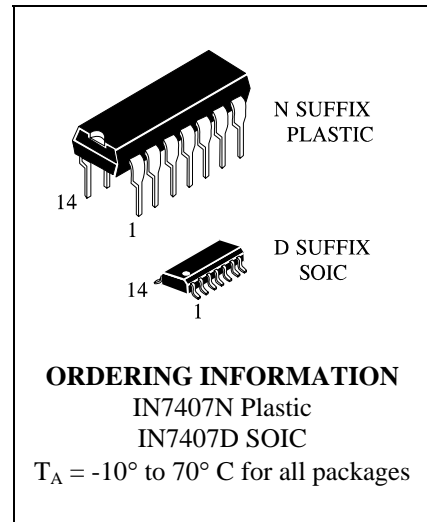

LOGIC DIAGRAM

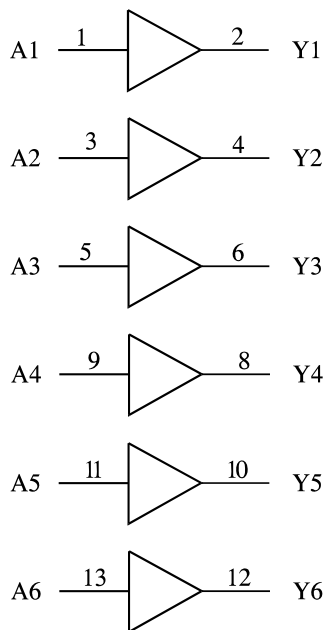

PIN 14 = V_{CC}
PIN 7 = GND

PIN ASSIGNMENT

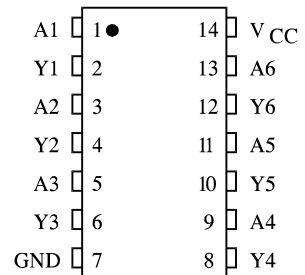

FUNCTION TABLE

Inputs	Output
A	Y
H	Z
L	L

Z = High Impedance

MAXIMUM RATINGS*

Symbol	Parameter	Value	Unit
V _{CC}	Supply Voltage	7.0	V
V _{IN}	Input Voltage	5.5	V
V _{OUT}	Output Voltage	30	V
T _{stg}	Storage Temperature Range	-65 to +150	°C

*Maximum Ratings are those values beyond which damage to the device may occur. Functional operation should be restricted to the Recommended Operating Conditions.

RECOMMENDED OPERATING CONDITIONS

Symbol	Parameter	Min	Max	Unit
V _{CC}	Supply Voltage	4.75	5.25	V
V _{IH}	High Level Input Voltage	2.0		V
V _{IL}	Low Level Input Voltage		0.8	V
U _{OH}	High Level Output Voltage		30	V
I _{OL}	Low Level Output Current		40	mA
T _A	Ambient Temperature Range	-10	+70	°C

DC ELECTRICAL CHARACTERISTICS over full operating conditions

Symbol	Parameter	Test Conditions	Guaranteed Limit		Unit	
			Min	Max		
V _{IK}	Input Clamp Voltage	V _{CC} = min, I _{IN} = -12 mA		-1.5	V	
I _{OH}	High Level Output Current	V _{CC} = min, V _{OH} = max		0.25	mA	
V _{OL}	Low Level Output Voltage	V _{CC} = min, I _{OL} = 16 mA		0.4	V	
		V _{CC} = min, I _{OL} = 40 mA		0.7		
I _{IH}	High Level Input Current	V _{CC} = max, V _{IN} = 2.4 V		0.04	μA	
		V _{CC} = max, V _{IN} = 5.5 V		1.0	mA	
I _{IL}	Low Level Input Current	V _{CC} = max, V _{IN} = 0.4 V		-1.6	mA	
I _{CC}	Supply Current	V _{CC} = max	Outputs High		41	mA
			Outputs Low		30	

AC ELECTRICAL CHARACTERISTICS (T = 25°C, V_{CC} = 5.0 V, C_L = 15 pF, R_L = 110 Ω, Input t_r = t_f = 10 ns)

Symbol	Parameter	Min	Max	Unit
t _{PLH}	Propagation Delay Time, Low to High Level Output (from Input to Output)		10	ns
t _{PHL}	Propagation Delay Time, High to Low Level Output (from Input to Output)		35	ns

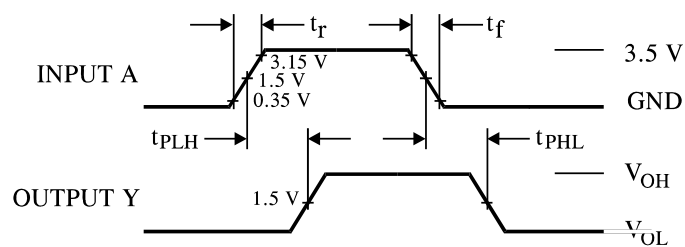
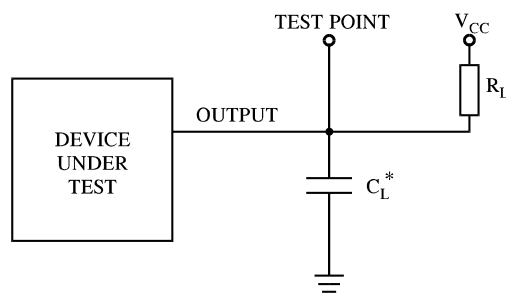

Figure 1. Switching Waveforms



* Includes all probe and jig capacitance

Figure 2. Test Circuit

**N SUFFIX PLASTIC DIP
(MS - 001AA)**

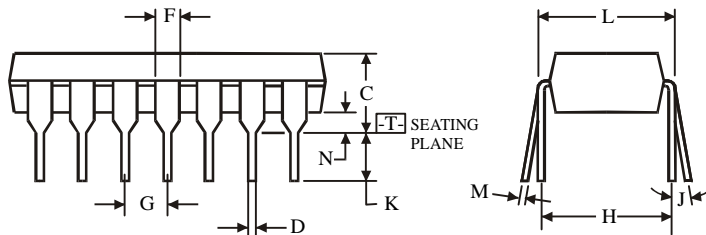
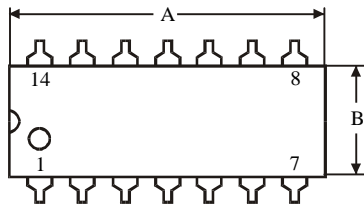
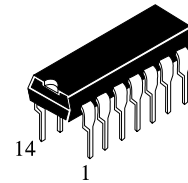

$\oplus 0.25 (0.010) \text{ (M) T}$

NOTES:

- Dimensions "A", "B" do not include mold flash or protrusions.
Maximum mold flash or protrusions 0.25 mm (0.010) per side.

Symbol	Dimension, mm	
	MIN	MAX
A	18.67	19.69
B	6.1	7.11
C		5.33
D	0.36	0.56
F	1.14	1.78
G	2.54	
H	7.62	
J	0°	10°
K	2.92	3.81
L	7.62	8.26
M	0.2	0.36
N	0.38	

**D SUFFIX SOIC
(MS - 012AB)**

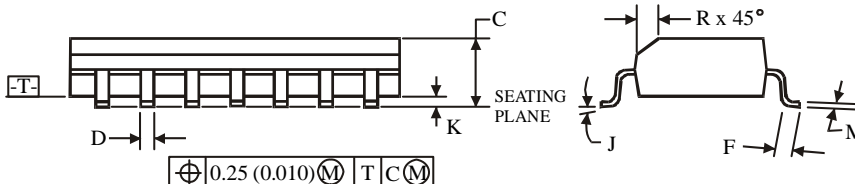
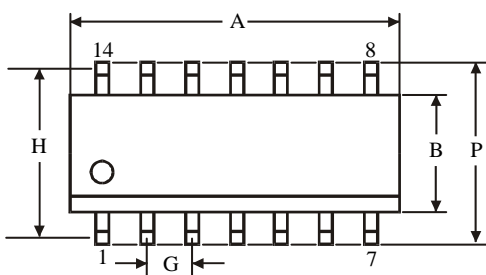
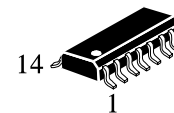

$\oplus 0.25 (0.010) \text{ (M) T C (M)}$

NOTES:

- Dimensions A and B do not include mold flash or protrusion.
- Maximum mold flash or protrusion 0.15 mm (0.006) per side for A; for B - 0.25 mm (0.010) per side.

Symbol	Dimension, mm	
	MIN	MAX
A	8.55	8.75
B	3.8	4
C	1.35	1.75
D	0.33	0.51
F	0.4	1.27
G	1.27	
H	5.27	
J	0°	8°
K	0.1	0.25
M	0.19	0.25
P	5.8	6.2
R	0.25	0.5