

# Octal 3-State Inverting Transparent Latch High-Speed Silicon-Gate CMOS

**IN74AC533**

The IN74AC533 is identical in pinout to the LS/ALS533, HC/HCT533. The device inputs are compatible with standard CMOS outputs; with pullup resistors, they are compatible with LS/ALS outputs.

These latches appear transparent to data (i.e., the outputs change asynchronously) when Latch Enable is high. The data appears as the outputs in inverted form. When Latch Enable goes low, data meeting the setup and hold time becomes latched.

The Output Enable input does not affect the state of the latches, but when Output Enable is high, all device outputs are forced to the high-impedance state. Thus, data may be latched even when the outputs are not enabled.

- Outputs Directly Interface to CMOS, NMOS, and TTL
- Operating Voltage Range: 2.0 to 6.0 V
- Low Input Current: 1.0  $\mu$ A; 0.1  $\mu$ A @ 25°C
- High Noise Immunity Characteristic of CMOS Devices
- Outputs Source/Sink 24 mA
- 3-State Outputs for Bus Interfacing

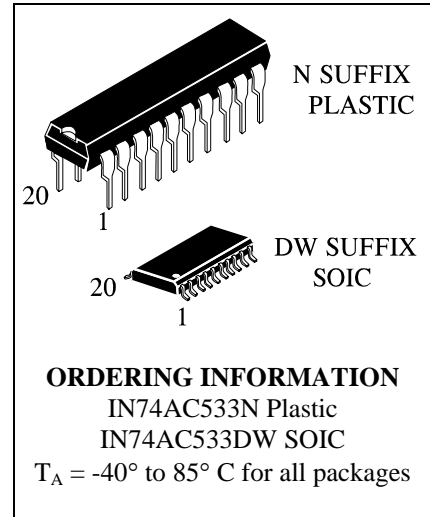

## LOGIC DIAGRAM

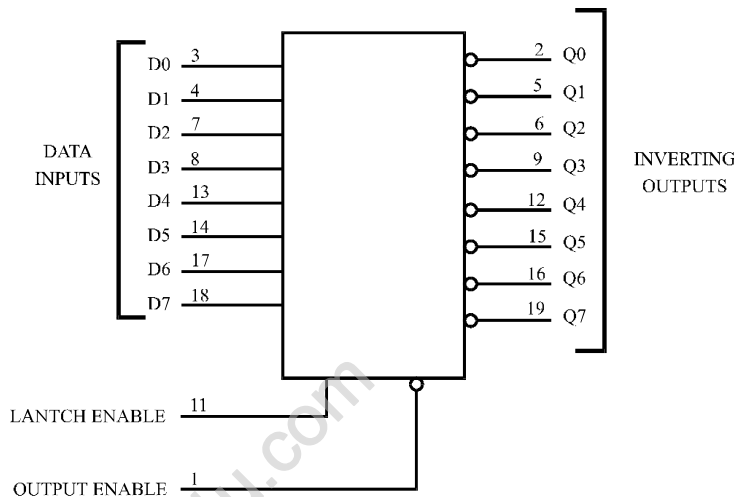

PIN 20 =  $V_{CC}$   
 PIN 10 = GND

## PIN ASSIGNMENT

Output Enable	1 ●	20	$V_{CC}$
Q0	2	19	Q7
D0	3	18	D7
D1	4	17	D6
Q1	5	16	Q6
Q2	6	15	Q5
D2	7	14	D5
D3	8	13	D4
Q3	9	12	Q4
GND	10	11	Latch Enable

## FUNCTION TABLE

Inputs			Output
Output Enable	Latch Enable	D	Q
L	H	H	L
L	H	L	H
L	L	X	no change
H	X	X	Z

X = don't care  
 Z = high impedance

**MAXIMUM RATINGS\***

Symbol	Parameter	Value	Unit
V <sub>CC</sub>	DC Supply Voltage (Referenced to GND)	-0.5 to +7.0	V
V <sub>IN</sub>	DC Input Voltage (Referenced to GND)	-0.5 to V <sub>CC</sub> +0.5	V
V <sub>OUT</sub>	DC Output Voltage (Referenced to GND)	-0.5 to V <sub>CC</sub> +0.5	V
I <sub>IN</sub>	DC Input Current, per Pin	±20	mA
I <sub>OUT</sub>	DC Output Sink/Source Current, per Pin	±50	mA
I <sub>CC</sub>	DC Supply Current, V <sub>CC</sub> and GND Pins	±50	mA
P <sub>D</sub>	Power Dissipation in Still Air, Plastic DIP+ SOIC Package+	750 500	mW
T <sub>stg</sub>	Storage Temperature	-65 to +150	°C
T <sub>L</sub>	Lead Temperature, 1 mm from Case for 10 Seconds (Plastic DIP or SOIC Package)	260	°C

\*Maximum Ratings are those values beyond which damage to the device may occur. Functional operation should be restricted to the Recommended Operating Conditions.

+Derating - Plastic DIP: - 10 mW/°C from 65° to 125°C

SOIC Package: - 7 mW/°C from 65° to 125°C

**RECOMMENDED OPERATING CONDITIONS**

Symbol	Parameter	Min	Max	Unit	
V <sub>CC</sub>	DC Supply Voltage (Referenced to GND)	2.0	6.0	V	
V <sub>IN</sub> , V <sub>OUT</sub>	DC Input Voltage, Output Voltage (Referenced to GND)	0	V <sub>CC</sub>	V	
T <sub>J</sub>	Junction Temperature (PDIP)		140	°C	
T <sub>A</sub>	Operating Temperature, All Package Types	-40	+85	°C	
I <sub>OH</sub>	Output Current - High		-24	mA	
I <sub>OL</sub>	Output Current - Low		24	mA	
t <sub>r</sub> , t <sub>f</sub>	Input Rise and Fall Time * (except Schmitt Inputs)	V <sub>CC</sub> =3.0 V V <sub>CC</sub> =4.5 V V <sub>CC</sub> =5.5 V	0 0 0	150 40 25	ns/V

\* V<sub>IN</sub> from 30% to 70% V<sub>CC</sub>

This device contains protection circuitry to guard against damage due to high static voltages or electric fields. However, precautions must be taken to avoid applications of any voltage higher than maximum rated voltages to this high-impedance circuit. For proper operation, V<sub>IN</sub> and V<sub>OUT</sub> should be constrained to the range GND ≤ (V<sub>IN</sub> or V<sub>OUT</sub>) ≤ V<sub>CC</sub>.

Unused inputs must always be tied to an appropriate logic voltage level (e.g., either GND or V<sub>CC</sub>). Unused outputs must be left open.

**DC ELECTRICAL CHARACTERISTICS** (Voltages Referenced to GND)

Symbol	Parameter	Test Conditions	V <sub>CC</sub> V	Guaranteed Limits		Unit	
				25 °C	-40°C to 85°C		
V <sub>IH</sub>	Minimum High-Level Input Voltage	V <sub>OUT</sub> =0.1 V or V <sub>CC</sub> -0.1 V	3.0	2.1	2.1	V	
			4.5	3.15	3.15		
			5.5	3.85	3.85		
V <sub>IL</sub>	Maximum Low - Level Input Voltage	V <sub>OUT</sub> =0.1 V or V <sub>CC</sub> -0.1 V	3.0	0.9	0.9	V	
			4.5	1.35	1.35		
			5.5	1.65	1.65		
V <sub>OH</sub>	Minimum High-Level Output Voltage	I <sub>OUT</sub> ≤ -50 μA	3.0	2.9	2.9	V	
			4.5	4.4	4.4		
			5.5	5.4	5.4		
			*V <sub>IN</sub> =V <sub>IH</sub> or V <sub>IL</sub> I <sub>OH</sub> =-12 mA	3.0	2.56		2.46
			I <sub>OH</sub> =-24 mA I <sub>OH</sub> =-24 mA	4.5	3.86		3.76
5.5	4.86	4.76					
V <sub>OL</sub>	Maximum Low-Level Output Voltage	I <sub>OUT</sub> ≤ 50 μA	3.0	0.1	0.1	V	
			4.5	0.1	0.1		
			5.5	0.1	0.1		
			*V <sub>IN</sub> =V <sub>IH</sub> or V <sub>IL</sub> I <sub>OL</sub> =12 mA	3.0	0.36		0.44
			I <sub>OL</sub> =24 mA I <sub>OL</sub> =24 mA	4.5	0.36		0.44
5.5	0.36	0.44					
I <sub>IN</sub>	Maximum Input Leakage Current	V <sub>IN</sub> =V <sub>CC</sub> or GND	5.5	±0.1	±1.0	μA	
I <sub>OZ</sub>	Maximum Three-State Leakage Current	V <sub>IN</sub> (OE)= V <sub>IH</sub> or V <sub>IL</sub> V <sub>IN</sub> =V <sub>CC</sub> or GND V <sub>OUT</sub> =V <sub>CC</sub> or GND	5.5	±0.5	±5.0	μA	
I <sub>OLD</sub>	+Minimum Dynamic Output Current	V <sub>OLD</sub> =1.65 V Max	5.5		75	mA	
I <sub>OHD</sub>	+Minimum Dynamic Output Current	V <sub>OHD</sub> =3.85 V Min	5.5		-75	mA	
I <sub>CC</sub>	Maximum Quiescent Supply Current (per Package)	V <sub>IN</sub> =V <sub>CC</sub> or GND	5.5	8.0	80	μA	

\* All outputs loaded; thresholds on input associated with output under test.

+Maximum test duration 2.0 ms, one output loaded at a time.

Note: I<sub>IN</sub> and I<sub>CC</sub> @ 3.0 V are guaranteed to be less than or equal to the respective limit @ 5.5 V V<sub>CC</sub>

**AC ELECTRICAL CHARACTERISTICS** ( $C_L=50\text{pF}$ , Input  $t_r=t_f=3.0\text{ ns}$ )

Symbol	Parameter	$V_{CC}^*$ V	Guaranteed Limits				Unit
			25 °C		-40°C to 85°C		
			Min	Max	Min	Max	
$t_{PLH}$	Propagation Delay, Input D to Q (Figure 1)	3.3 5.0	2.0 2.0	14.0 10.0	1.5 1.5	16.0 11.0	ns
$t_{PHL}$	Propagation Delay, Input D to Q (Figure 1)	3.3 5.0	2.0 2.0	13.0 9.5	1.5 1.5	14.5 10.5	ns
$t_{PLH}$	Propagation Delay, Latch Enable to Q (Figure 2)	3.3 5.0	2.0 2.0	14.0 10.0	1.5 1.5	16.5 11.5	ns
$t_{PHL}$	Propagation Delay, Latch Enable to Q (Figure 2)	3.3 5.0	2.0 2.0	13.0 10.0	1.5 1.5	14.5 11.0	ns
$t_{PZH}$	Propagation Delay, Output Enable to Q (Figure 3)	3.3 5.0	2.0 2.0	12.5 9.5	1.5 1.5	14.0 10.5	ns
$t_{PZL}$	Propagation Delay, Output Enable to Q (Figure 3)	3.3 5.0	2.0 2.0	12.5 9.5	1.5 1.5	14.0 10.5	ns
$t_{PHZ}$	Propagation Delay, Output Enable to Q (Figure 3)	3.3 5.0	2.0 2.0	13.0 10.0	1.5 1.5	14.5 11.0	ns
$t_{PLZ}$	Propagation Delay, Output Enable to Q (Figure 3)	3.3 5.0	2.0 2.0	13.0 10.0	1.5 1.5	14.5 11.0	ns
$C_{IN}$	Maximum Input Capacitance	5.0	4.5		4.5		pF

$C_{PD}$	Power Dissipation Capacitance	Typical @25°C, $V_{CC}=5.0\text{ V}$		pF
		40		

\*Voltage Range 3.3 V is 3.3 V  $\pm$ 0.3 V

Voltage Range 5.0 V is 5.0 V  $\pm$ 0.5 V

**TIMING REQUIREMENTS** ( $C_L=50\text{pF}$ , Input  $t_r=t_f=3.0\text{ ns}$ )

Symbol	Parameter	$V_{CC}^*$ V	Guaranteed Limits		Unit
			25 °C		
			-40°C to 85°C		
$t_{su}$	Minimum Setup Time, Input D to Latch Enable (Figure 4)	3.3 5.0	5.5 4.0	6.0 4.5	ns
$t_h$	Minimum Hold Time, Latch Enable to Input D (Figure 4)	3.3 5.0	1.5 1.5	1.0 1.0	ns
$t_w$	Minimum Pulse Width, Latch Enable (Figure 2)	3.3 5.0	6.0 4.5	6.5 5.0	ns

\*Voltage Range 3.3 V is 3.3 V  $\pm$ 0.3 V

Voltage Range 5.0 V is 5.0 V  $\pm$ 0.5 V

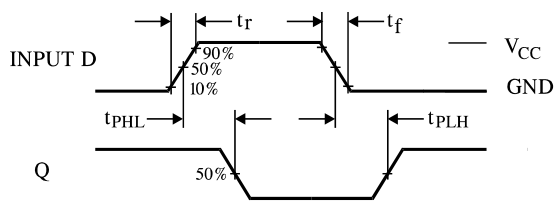

Figure 1. Switching Waveforms

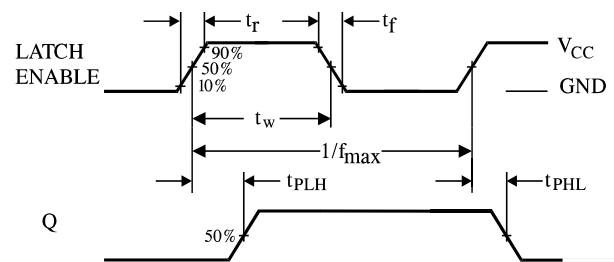

Figure 2. Switching Waveforms

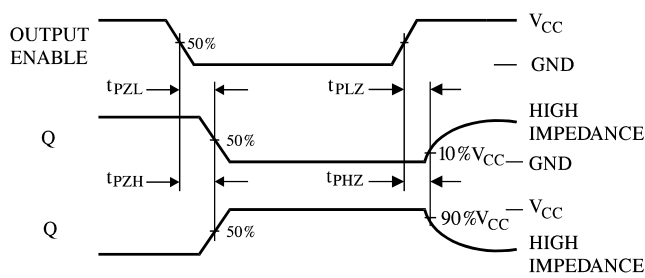

Figure 3. Switching Waveforms

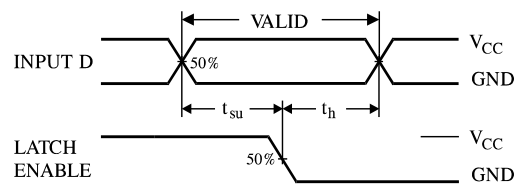
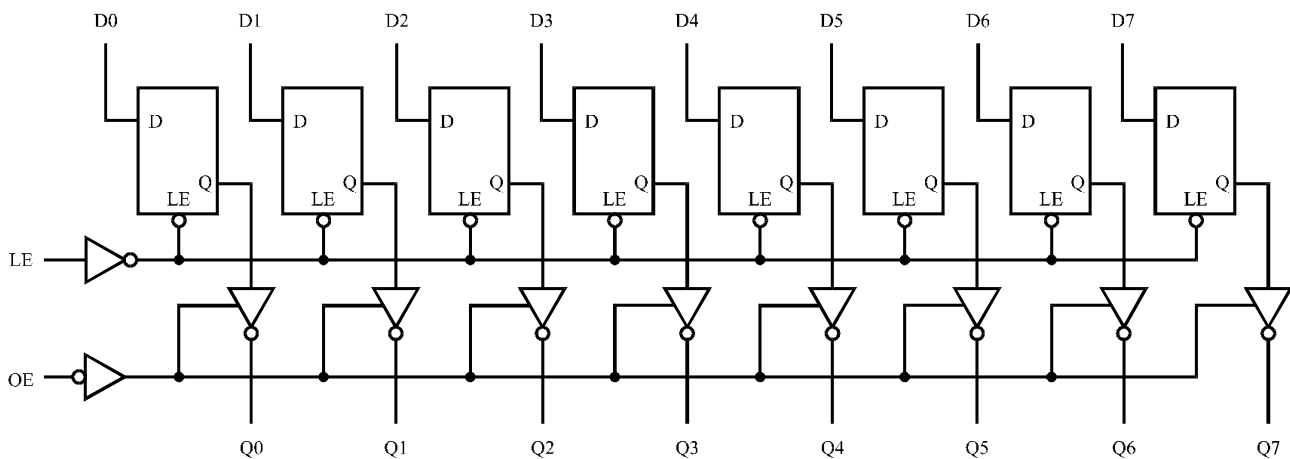
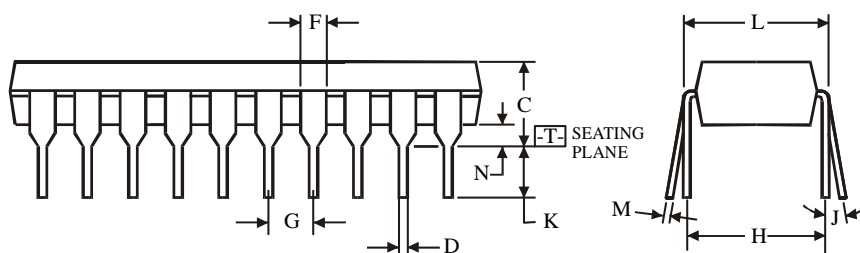
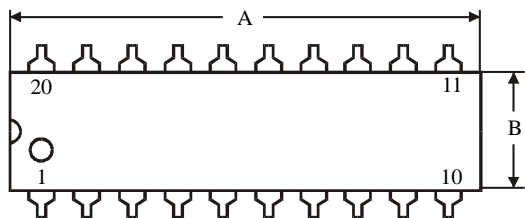
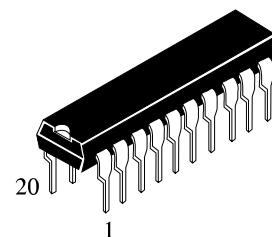

Figure 4. Switching Waveforms

EXPANDED LOGIC DIAGRAM



**N SUFFIX PLASTIC DIP**  
(MS - 001AD)



$\oplus 0.25 (0.010) \text{ (M) T}$

**NOTES:**

- Dimensions "A", "B" do not include mold flash or protrusions.  
Maximum mold flash or protrusions 0.25 mm (0.010) per side.

Symbol	Dimension, mm	
	MIN	MAX
A	24.89	26.92
B	6.1	7.11
C		5.33
D	0.36	0.56
F	1.14	1.78
G	2.54	
H	7.62	
J	0°	10°
K	2.92	3.81
L	7.62	8.26
M	0.2	0.36
N	0.38	

**D SUFFIX SOIC**  
(MS - 013AC)

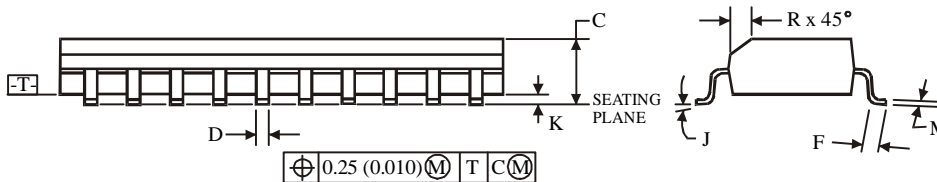
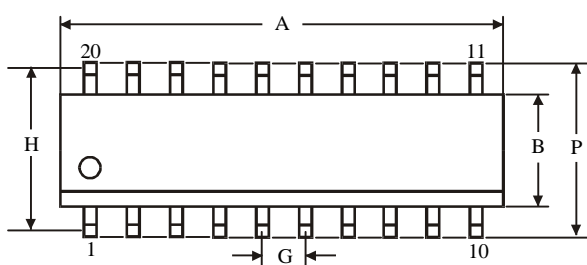
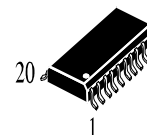

$\oplus 0.25 (0.010) \text{ (M) T C (M)}$

**NOTES:**

- Dimensions A and B do not include mold flash or protrusion.
- Maximum mold flash or protrusion 0.15 mm (0.006) per side  
for A; for B - 0.25 mm (0.010) per side.

Symbol	Dimension, mm	
	MIN	MAX
A	12.6	13
B	7.4	7.6
C	2.35	2.65
D	0.33	0.51
F	0.4	1.27
G	1.27	
H	9.53	
J	0°	8°
K	0.1	0.3
M	0.23	0.32
P	10	10.65
R	0.25	0.75