

IN74VHC08

Quad 2-Input AND Gate

IN74VHC08 is high-speed logic IC made by CMOS technology and designed for use in high-performance calculating systems with a wide supply voltage range.

As for operation speed, IN74VHC08 can be compared with equivalent bipolar ICs based on Schottky TTL and two times surpasses ICs of IN74HC series.

IN74VHC08 tolerates operation under conditions when voltage on input is exceeded up to 7V without affecting characteristics and IC reliability. This possibility allows to use IN74VHC08 in radio-electronic devices for interfacing with supply voltages 5V and 3V, eliminate IC failure under supply voltage source emergency outage.

Use of output edge shaping block in the microcircuit allows to reduce noise amplitude of noises when switching outputs into the same state simultaneously.

Input and output levels of IN74VHC08 are compatible with CMOS levels

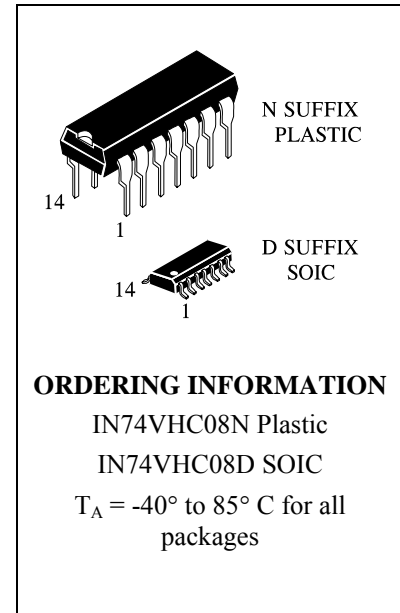

Features:

- Supply voltage range 2.0 to 5.5 V.
- Output current 8 mA.
- Low consumption current: 0.2 mA (typical value) at $T_a = 25^\circ\text{C}$.
- Latchup current not less than 300 mA at $T_a = 85^\circ\text{C}$.
- Tolerable value of static potential not less than 2000 V as per human body model (HBM) and not less than 200 V as per machine model (MM).
- Ambient operation temperature minus 40 to plus 85 $^\circ\text{C}$.
- Balanced signal propagation delay.
- Ensures voltage exceeding mode on input
- Low noise level at the simultaneous switching of outputs in the same state: $V_{OLP} = 0.8$ V (max).
- For pins and functions, compatible with IN74HC08.

IN74VHC08 truth table

| Input | | Output |
|-------|---|-------------|
| A | B | $Y = A * B$ |
| L | L | L |
| L | H | L |
| H | L | L |
| H | H | H |

Note –
 H - high voltage level;
 L - low voltage level;

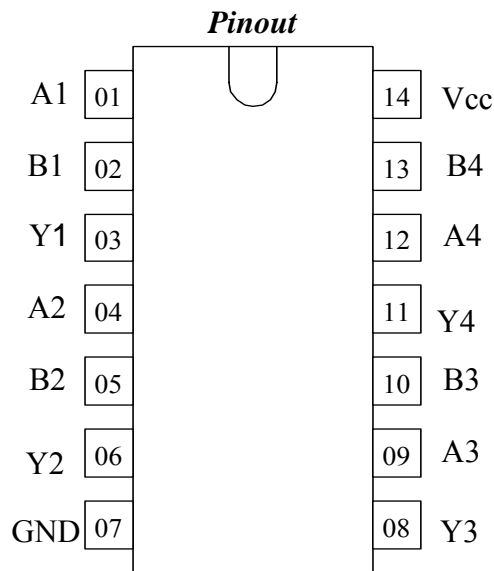

Pins description in IN74VHC08

| Pin No. | Symbol | Description |
|---------|-----------------|-----------------------------------|
| 01 | A1 | Input |
| 02 | B1 | Input |
| 03 | Y1 | Output |
| 04 | A2 | Input |
| 05 | B2 | Input |
| 06 | Y2 | Output |
| 07 | GND | Common output |
| 08 | Y3 | Output |
| 09 | A3 | Input |
| 10 | B3 | Input |
| 11 | Y4 | Output |
| 12 | A4 | Input |
| 13 | B4 | Input |
| 14 | V _{CC} | Supply output from voltage source |

Absolute maximum conditions*

| Parameter, unit | Symbol | Value | |
|--|-----------|-------|---------------|
| | | min | max |
| Supply voltage, V | V_{CC} | -0.5 | 7.0 |
| Input voltage, V | V_{in} | -0.5 | 7.0 |
| Output voltage, V | V_{out} | -0.5 | $V_{CC}+0.5V$ |
| Input diode current, mA | I_{ik} | – | -20 |
| Current of common output and supply output, mA | I_{cc} | – | ± 50 |
| Output current, mA | I_{out} | – | ± 25 |
| Output diode current, mA | I_{ok} | – | ± 20 |
| Dissipated power, mW | P_d | – | 180 |

*Under absolute maximum conditions operation of microcircuit is not guaranteed. Operation is guaranteed under maximum conditions

Maximum conditions

| Parameter, unit | Symbol | Value | |
|--------------------------------|------------------|-------|-----------|
| | | min | max |
| Supply voltage, V | V_{CC} | 2.0 | 5.5 |
| Input voltage, V | V_{in} | 0 | V_{CC} |
| Output voltage, V | V_{out} | 0 | V_{CC} |
| Output current, mA | I_{out} | – | ± 8.0 |
| Input rise and fall time, ns/V | t_{LH}, t_{HL} | 0 | 100 |
| at $V_{CC} = (3.3 \pm 0.3) V$ | | 0 | 20 |
| at $V_{CC} = (5.0 \pm 0.5) V$ | | | |

DC electrical characteristics

| Symbol | Parameter | Test conditions | V _{CC} , V | Value | | | | Unit | |
|------------------|---------------------------|---|--|---------------------|---------------------|---------------------|---------------------|------|------|
| | | | | 25 °C | | -40 to 85 °C | | | |
| | | | | min | max | min | max | | |
| V _{IH} | High level input voltage | V _O ≤ 0.1 V or V _O ≥ V _{CC} - 0.1 V | 2.0 | 1.5 | - | 1.5 | - | V | |
| | | | 3.0 | 0.7 V _{CC} | | 0.7 V _{CC} | | | |
| | | | 4.5 | 0.7 V _{CC} | | 0.7 V _{CC} | | | |
| | | | 5.5 | 0.7 V _{CC} | | 0.7 V _{CC} | | | |
| V _{IL} | Low level input voltage | V _O ≤ 0.1 V or V _O ≥ V _{CC} - 0.1 V | 2.0 | - | 0.5 | | 0.5 | | |
| | | | 3.0 | | 0.3 V _{CC} | | 0.3 V _{CC} | | |
| | | | 4.5 | | 0.3 V _{CC} | | 0.3 V _{CC} | | |
| | | | 5.5 | | 0.3 V _{CC} | | 0.3 V _{CC} | | |
| V _{OH} | High level output voltage | V _I = V _{IH} or V _{IL} I _{OH} = -50 uA | 2.0 | 1.92 | - | 1.9 | - | | |
| | | | 3.0 | 2.92 | | 2.9 | | | |
| | | | 4.5 | 4.42 | | 4.4 | | | |
| | | | 5.5 | 5.42 | | 5.4 | | | |
| | | | V _I = V _{IH} or V _{IL} I _{OH} = -4 mA | 3.0 | 2.58 | | 2.48 | | |
| | | | V _I = V _{IH} or V _{IL} I _{OH} = -8 mA | 4.5 | 3.94 | | 3.8 | | |
| V _{OL} | Low level output voltage | V _I = V _{IH} or V _{IL} I _{OL} = 50 uA | 2.0 | - | 0.09 | - | 0.1 | | |
| | | | 3.0 | | 0.09 | | 0.1 | | |
| | | | 4.5 | | 0.09 | | 0.1 | | |
| | | | 5.5 | | 0.09 | | 0.1 | | |
| | | | V _I = V _{IH} or V _{IL} I _{OL} = 4 mA | 3.0 | | 0.36 | | | 0.44 |
| | | | V _I = V _{IH} or V _{IL} I _{OL} = 8 mA | 4.5 | | 0.36 | | | 0.44 |
| I _{IL} | Low level input current | V _I = 0 B | 5.5 | | -0.1 | | -1.0 | uA | |
| I _{IH} | High level input current | V _I = V _{CC} | 5.5 | | 0.1 | | 1.0 | | |
| I _{IH1} | High level input current | V _I = 5.5 B | 0 | | 0.1 | | 1.0 | | |
| I _{CC} | Consumption current | V _I = 0 B или V _{CC} | 5.5 | | 2.0 | | 20 | | |

AC electrical characteristics ($t_{LH} = t_{HL} = 3.0 \text{ ns}$, $V_{IL} = 0 \text{ V}$, $V_{IH} = V_{CC}$.)

| Symbol | Parameter | Test conditions | V_{CC} , V | C_L , pF | Value | | | | Unit |
|--------------------|---|---------------------------------|---------------|------------|-------|------|--------------|------|------|
| | | | | | 25 °C | | -40 to 85 °C | | |
| | | | | | min | max | min | max | |
| t_{PHL}, t_{PLH} | Propagation delay time when switching "on", "off" | | 3.3 ± 0.3 | 15 | - | 8.8 | - | 10.5 | ns |
| | | | | 50 | | 12.3 | | 14.0 | |
| | | | 5.0 ± 0.5 | 15 | | 5.9 | | 7.0- | |
| | | | | 50 | | 7.9 | | 9.0 | |
| C_I | Input capacity | - | 5.0 | | | 10 | | pF | |
| C_{PD} | Dynamic capacity | $V_I = 0 \text{ V}$ or V_{CC} | 5.0 | | | 36 | | | |

Noise characteristics ($C_L = 50 \text{ pF}$)

| Symbol | Parameter | V_{CC} , V | Value | | Unit |
|-----------|--------------------------------------|--------------|-------|-----|------|
| | | | min | max | |
| V_{OLP} | Positive noise of low output voltage | 5.0 | - | 0.8 | V |
| V_{OLV} | Negative noise of low output voltage | 5.0 | -0.8 | - | |
| V_{IHD} | Input dynamic high voltage | 5.0 | 3.5 | - | |
| V_{ILD} | Input dynamic low voltage | 5.0 | - | 1.5 | |

- Time diagram of input and output pulses

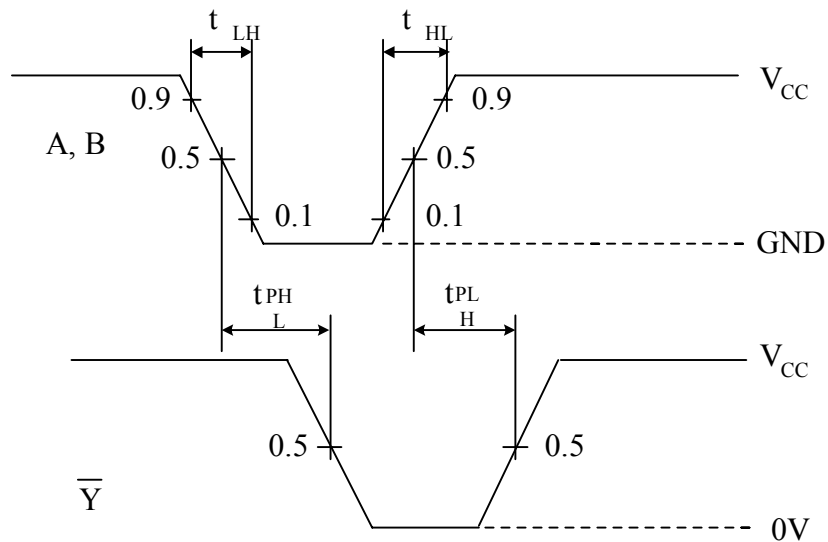

**N SUFFIX PLASTIC DIP
(MS - 001AA)**

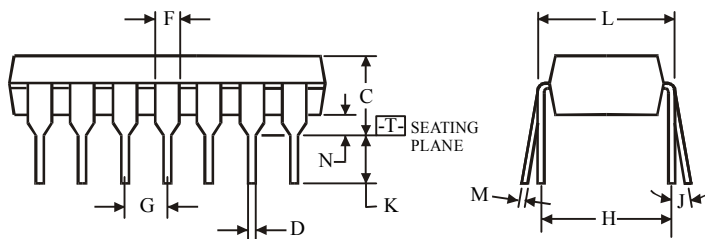
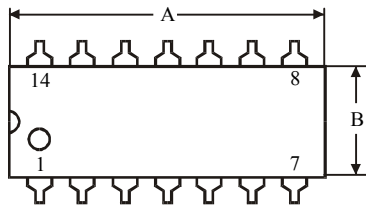
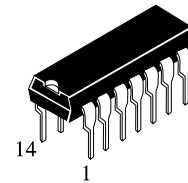

$\oplus 0.25 (0.010) \text{ (M) } \text{ T}$

NOTES:

- Dimensions "A", "B" do not include mold flash or protrusions.
Maximum mold flash or protrusions 0.25 mm (0.010) per side.

| Symbol | Dimension, mm | |
|--------|---------------|-------|
| | MIN | MAX |
| A | 18.67 | 19.69 |
| B | 6.1 | 7.11 |
| C | | 5.33 |
| D | 0.36 | 0.56 |
| F | 1.14 | 1.78 |
| G | 2.54 | |
| H | 7.62 | |
| J | 0° | 10° |
| K | 2.92 | 3.81 |
| L | 7.62 | 8.26 |
| M | 0.2 | 0.36 |
| N | 0.38 | |

**D SUFFIX SOIC
(MS - 012AB)**

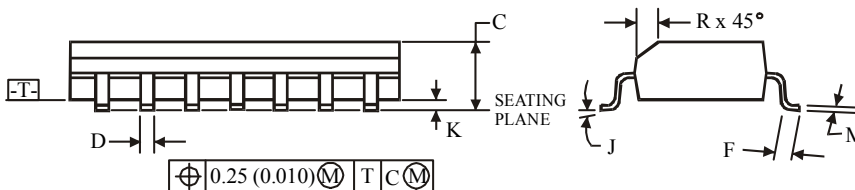
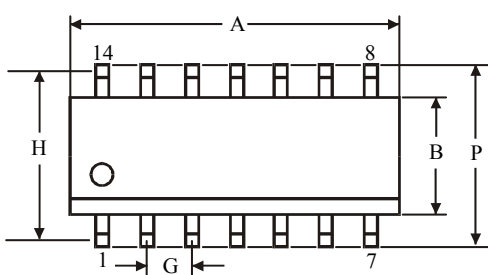
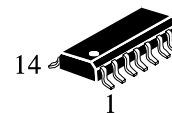

$\oplus 0.25 (0.010) \text{ (M) } \text{ T } \text{ C } \text{ (M)}$

NOTES:

- Dimensions A and B do not include mold flash or protrusion.
- Maximum mold flash or protrusion 0.15 mm (0.006) per side for A; for B - 0.25 mm (0.010) per side.

| Symbol | Dimension, mm | |
|--------|---------------|------|
| | MIN | MAX |
| A | 8.55 | 8.75 |
| B | 3.8 | 4 |
| C | 1.35 | 1.75 |
| D | 0.33 | 0.51 |
| F | 0.4 | 1.27 |
| G | 1.27 | |
| H | 5.27 | |
| J | 0° | 8° |
| K | 0.1 | 0.25 |
| M | 0.19 | 0.25 |
| P | 5.8 | 6.2 |
| R | 0.25 | 0.5 |