

IN74VHC241

Octal Buffer/Line driver, INV (3-State)

IN74VHC241 is high-speed logic IC made by CMOS technology and designed for use in high-performance calculating systems with a wide supply voltage range.

As for operation speed, IN74VHC241 can be compared with equivalent bipolar ICs based on Schottky TTL and two times surpasses ICs of IN74HC series.

IN74VHC241 tolerates operation under conditions when voltage on input is exceeded up to 7V without affecting characteristics and IC reliability. This possibility allows to use IN74VHC241 in radio-electronic devices for interfacing with supply voltages 5V and 3V, eliminate IC failure under supply voltage source emergency outage.

Use of output edge shaping block in the microcircuit allows to reduce noise amplitude of noises when switching outputs into the same state simultaneously.

Input and output levels of IN74VHC241 are compatible with CMOS levels

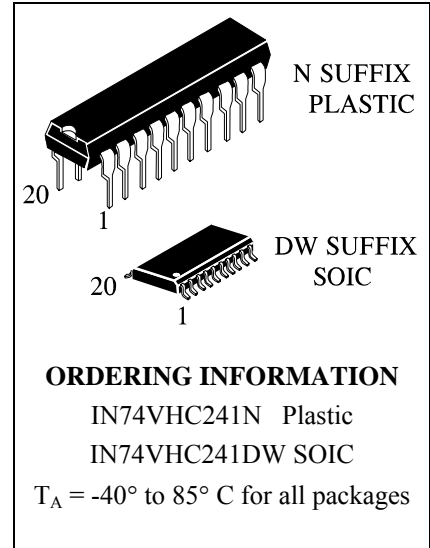

Features:

- Supply voltage range 2.0 to 5.5 V.
- Output current 8 mA.
- Low consumption current: 0.2 mA (typical value) at $T_a = 25^\circ\text{C}$.
- Latchup current not less than 300 mA at $T_a = 85^\circ\text{C}$.
- Tolerable value of static potential not less than 2000 V as per human body model (HBM) and not less than 200 V as per machine model (MM).
- Ambient operation temperature minus 40 to plus 85 °C.
- Balanced signal propagation delay.
- Ensures voltage exceeding mode on input
- Low noise level at the simultaneous switching of outputs in the same state: $V_{OLP} = 0.8$ V (max).
- For pins and functions, compatible with IN74HC241.

IN74VHC241 truth table

Input		Output
$\overline{1G}$	1A	1Y
L	L	L
L	H	H
H	X	Z
Input		Output
2G	2A	2Y
H	L	L
H	H	H
L	X	Z

Note –
 H - high voltage level;
 L - low voltage level;
 X - any voltage level (low or high);
 Z - output in third state

Pins description in IN74VHC241

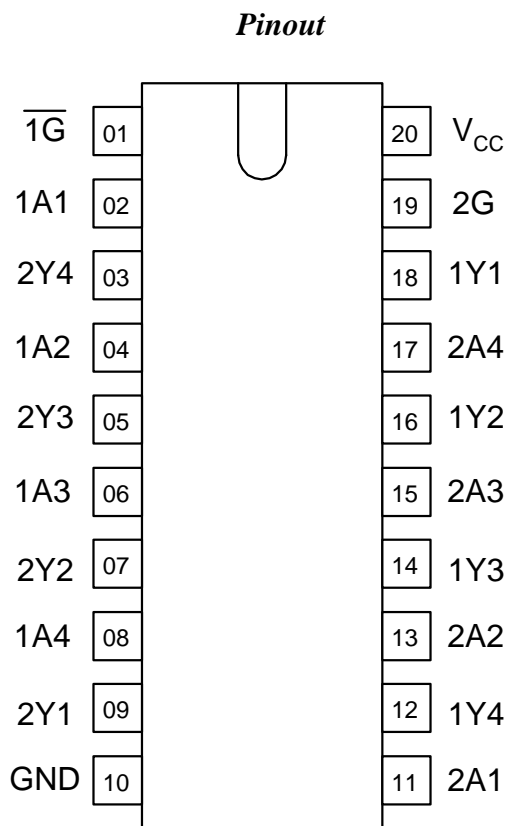

Pin No.	Symbol	Description
01	$\overline{1G}$	Input OUTPUT ENABLE
02	1A1	Data input
03	2Y4	Data output
04	1A2	Data input
05	2Y3	Data output
06	1A3	Data input
07	2Y2	Data output
08	1A4	Data input
09	2Y1	Data output
10	GND	Common output
11	2A1	Data input
12	1Y4	Data output
13	2A2	Data input
14	1Y3	Data output
15	2A3	Data input
16	1Y2	Data output
17	2A4	Data input
18	1Y1	Data output
19	2G	Input OUTPUT ENABLE
20	V _{CC}	Supply output from voltage source

Absolute maximum conditions*

Parameter, unit	Symbol	Value	
		min	max
Supply voltage, V	V_{CC}	-0.5	7.0
Input voltage, V	V_{in}	-0.5	7.0
Output voltage, V	V_{out}	-0.5	$V_{CC}+0.5V$
Input diode current, mA	I_{ik}	–	-20
Current of common output and supply output, mA	I_{cc}	–	± 75
Output current, mA	I_{out}	–	± 25
Output diode current, mA	I_{ok}	–	± 20
Dissipated power, mW	P_d	–	180

*Under absolute maximum conditions operation of microcircuit is not guaranteed. Operation is guaranteed under maximum conditions

Maximum conditions

Parameter, unit	Symbol	Value	
		min	max
Supply voltage, V	V_{CC}	2.0	5.5
Input voltage, V	V_{in}	0	V_{CC}
Output voltage, V	V_{out}	0	V_{CC}
Output current, mA	I_{out}	–	± 8.0
Input rise and fall time, ns/V at $V_{CC} = (3.3 \pm 0.3) V$ at $V_{CC} = (5.0 \pm 0.5) V$	t_{LH}, t_{HL}	0 0	100 20

DC electrical characteristics

Symbol	Parameter	Test conditions	V _{CC} , V	Value				Unit
				25 °C		-40 to 85 °C		
				min	max	min	max	
V _{IH}	High input voltage	-	2.0	1.5	-	1.5	-	V
			3.0-5.5	0.7V _{CC}	-	0.7V _{CC}	-	
V _{IL}	Low input voltage	-	2.0	-	0.5	-	0.5	
			3.0-5.5	-	0.3V _{CC}	-	0.3V _{CC}	
V _{OH}	High output voltage	V _I = V _{IH} or V _{IL} ; I _O = -50 mA	2.0	1.92	-	1.9	-	
			3.0	2.92	-	2.9	-	
			4.5	4.42	-	4.4	-	
			5.5	5.52	-	5.4	-	
		3.0	2.58	-	2.48	-	-	
		4.5	3.94	-	3.80	-		
V _{OL}	Low output voltage	V _I = V _{IH} or V _{IL} ; I _O = 50 mA	2.0	-	0.09	-	0.1	
			3.0	-	0.09	-	0.1	
			4.5	-	0.09	-	0.1	
			5.5	-	0.09	-	0.1	
		3.0	-	0.36	-	0.44	-	
		4.5	-	0.36	-	0.44		
		5.5	-	0.36	-	0.44		
I _{OZ}	Output current in "off" state	V _I = V _{IH} or V _{IL} ; V _O = V _{CC} or 0V	5.5	-	±0.25	-	±2.5	mA
I _I	Input current	V _I = 5.5V or 0V	0 - 5.5	-	±0.1	-	±1.0	
I _{CC}	Consumption current	V _I = V _{CC} or 0V	5.5	-	4.0	-	40.0	

AC electrical characteristics ($t_{LH} = t_{HL} = 3.0$ ns)

Symbol	Parameter	Test conditions	V_{CC} , V	C_L , pF	Value				Unit
					25 °C		-40 to 85 °C		
					min	max	min	max	
t_{PHL}, t_{PLH}	Propagation delay time when switching "on", "off"	Figure 1	3.3 ± 0.3	15	-	8.4	-	10.0	ns
				50	-	11.9	-	13.5	
			5.0 ± 0.5	15	-	5.5	-	6.5	
				50	-	7.5	-	8.5	
t_{PHZ}, t_{PLZ}	Propagation delay time under transition from high, low level into "off" state	Figure 2	3.3 ± 0.3	50	-	14.0	-	16.0	ns
			5.0 ± 0.5	50	-	9.2	-	10.5	
t_{PZH}, t_{PZL}	Propagation delay time under transition from «off» state into high, low level	Figure 2	3.3 ± 0.3	15	-	10.6	-	12.5	ns
				50	-	14.1	-	16.0	
			5.0 ± 0.5	15	-	7.3	-	8.5	
				50	-	9.3	-	10.5	
t_{OSLH}, t_{OSHL}	Propagation delays difference between outputs	-	3.3 ± 0.3	50	-	1.5	-	1.5	ns
			5.5 ± 0.5	50	-	1.0	-	1.0	

Capacitance characteristics

Symbol	Parameter	Test conditions	V_{CC} , V	Value		Unit
				25 °C		
				min	max	
C_I	Input capacity	-	5.0		10	pF
C_O	Output capacity	-	5.0		12	pF
C_{PD}	Dynamic capacity	$V_I = 0$ V or V_{CC}	5.0		36	pF

Noise characteristics ($C_L = 50$ pF)

Symbol	Parameter	V_{CC} , V	Value		Unit
			min	max	
V_{OLP}	Positive noise of low output voltage	5.0	-	0.9	V
V_{OLV}	Negative noise of low output voltage	5.0	-0.9	-	V
V_{IHD}	Input dynamic high voltage	5.0	3.5	-	V
V_{ILD}	Input dynamic low voltage	5.0	-	1.5	V

- Time diagram of input and output pulses

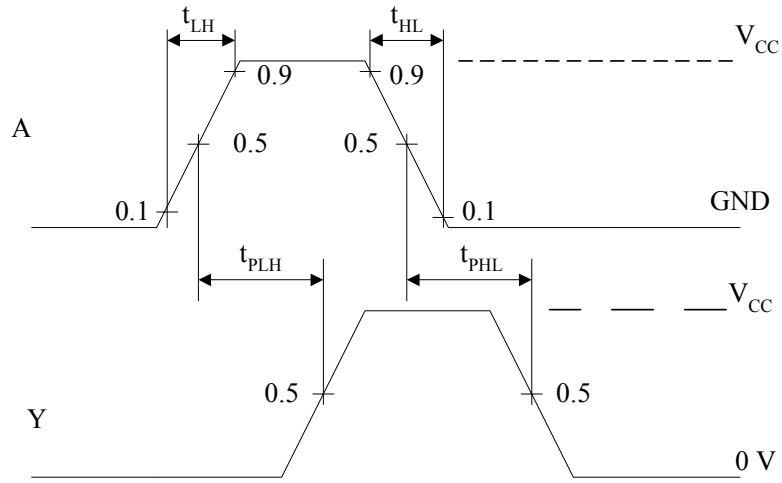

Fig. 1

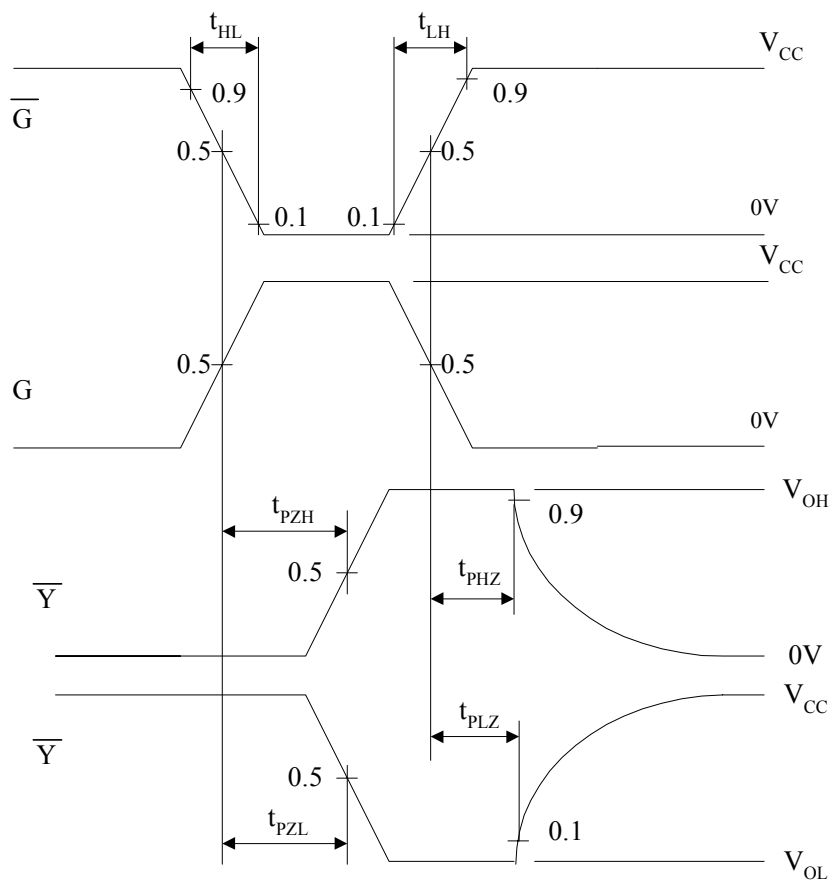
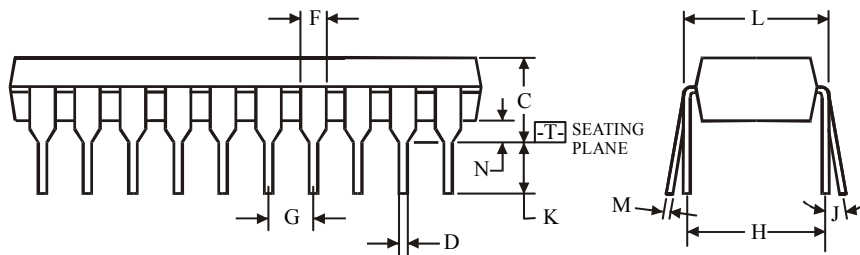
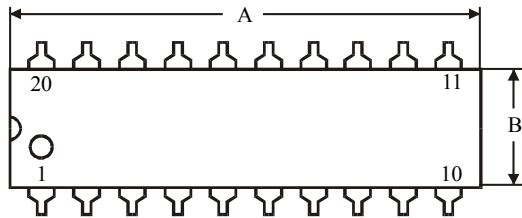
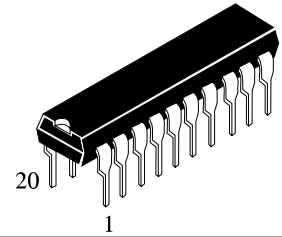

Fig.2

N SUFFIX PLASTIC DIP
(MS - 001AD)



$\oplus 0.25 (0.010) \text{ (M) T}$

NOTES:

- Dimensions "A", "B" do not include mold flash or protrusions.
Maximum mold flash or protrusions 0.25 mm (0.010) per side.

Symbol	Dimension, mm	
	MIN	MAX
A	24.89	26.92
B	6.1	7.11
C		5.33
D	0.36	0.56
F	1.14	1.78
G	2.54	
H	7.62	
J	0°	10°
K	2.92	3.81
L	7.62	8.26
M	0.2	0.36
N	0.38	

D SUFFIX SOIC
(MS - 013AC)

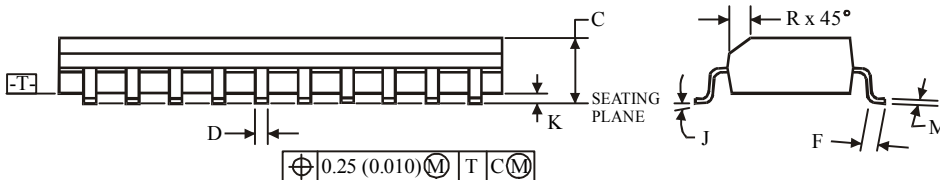
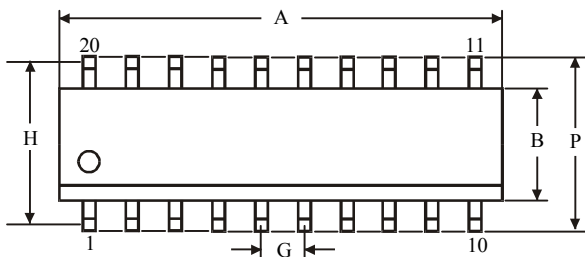
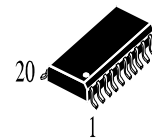

$\oplus 0.25 (0.010) \text{ (M) T C (M)}$

NOTES:

- Dimensions A and B do not include mold flash or protrusion.
- Maximum mold flash or protrusion 0.15 mm (0.006) per side for A; for B - 0.25 mm (0.010) per side.

Symbol	Dimension, mm	
	MIN	MAX
A	12.6	13
B	7.4	7.6
C	2.35	2.65
D	0.33	0.51
F	0.4	1.27
G	1.27	
H	9.53	
J	0°	8°
K	0.1	0.3
M	0.23	0.32
P	10	10.65
R	0.25	0.75