

Low Noise, Cascadable Silicon Bipolar MMIC Amplifier

Technical Data

INA-01170

Features

- **Cascadable 50 Ω Gain Block**
- **Low Noise Figure:**
1.7 dB Typical at 100 MHz
- **High Gain:**
32.5 dB Typical at 100 MHz
- **3 dB Bandwidth:**
DC to 500 MHz
- **Unconditionally Stable**
($k > 1$)
- **Hermetic Gold-Ceramic
Surface Mount Package**

Description

The INA-01170 is a low-noise silicon bipolar Monolithic Microwave Integrated Circuit (MMIC) feedback

amplifier housed in a hermetic, high reliability package. It is designed for narrow or wide bandwidth industrial and military applications that require high gain and low noise IF or RF amplification.

The INA series of MMICs is fabricated using HP's 10 GHz f_T , 25 GHz f_{MAX} , ISOSAT™-I silicon bipolar process which uses nitride self-alignment, submicrometer lithography, trench isolation, ion implantation, gold metallization and polyimide intermetal dielectric and scratch protection to achieve excellent performance, uniformity and reliability.

70 mil Package

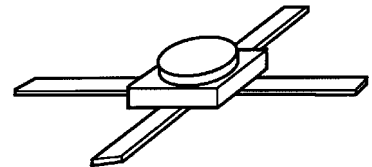

Typical Biasing Configuration

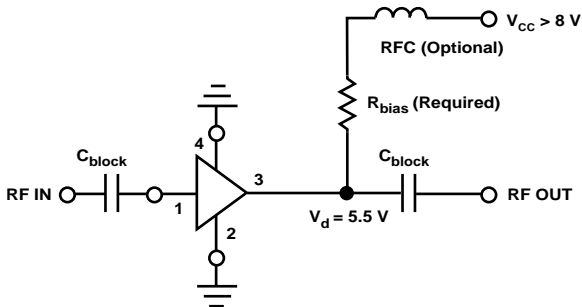

INA-01170 Absolute Maximum Ratings

Parameter	Absolute Maximum ^[1]
Device Current	50 mA
Power Dissipation ^[2,3]	400 mW
RF Input Power	+13 dBm
Junction Temperature	200°C
Storage Temperature	-65 to 200°C

Thermal Resistance^{[2,4]:}

$$\theta_{jc} = 140^{\circ}\text{C/W}$$

Notes:

1. Permanent damage may occur if any of these limits are exceeded.
2. $T_{\text{CASE}} = 25^{\circ}\text{C}$.
3. Derate at $7.1 \text{ mW}/^{\circ}\text{C}$ for $T_{\text{C}} > 144^{\circ}\text{C}$.
4. See MEASUREMENTS section "Thermal Resistance" for more information.

INA-01170 Electrical Specifications^[1], $T_{\text{A}} = 25^{\circ}\text{C}$

Symbol	Parameters and Test Conditions: $I_{\text{d}} = 35 \text{ mA}$, $Z_{\text{O}} = 50 \Omega$	Units	Min.	Typ.	Max.
G_{P}	Power Gain ($ S_{21} ^2$) $f = 100 \text{ MHz}$	dB	30	32.5	35
ΔG_{P}	Gain Flatness $f = 10 \text{ to } 250 \text{ MHz}$	dB		± 0.5	
$f_{3 \text{ dB}}$	3 dB Bandwidth ^[2]	MHz		500	
ISO	Reverse Isolation ($ S_{12} ^2$) $f = 10 \text{ to } 250 \text{ MHz}$	dB		39	
VSWR	Input VSWR $f = 10 \text{ to } 250 \text{ MHz}$			1.6:1	
	Output VSWR $f = 10 \text{ to } 250 \text{ MHz}$			1.5:1	
NF	50 Ω Noise Figure $f = 100 \text{ MHz}$	dB		2.0	2.5
$P_{1 \text{ dB}}$	Output Power at 1 dB Gain Compression $f = 100 \text{ MHz}$	dBm		11	
IP_3	Third Order Intercept Point $f = 100 \text{ MHz}$	dBm		23	
t_{D}	Group Delay $f = 100 \text{ MHz}$	psec		200	
V_{d}	Device Voltage	V	4.0	5.5	7.0
dV/dT	Device Voltage Temperature Coefficient	$\text{mV}/^{\circ}\text{C}$		+10	

Notes:

1. The recommended operating current range for this device is 30 to 40 mA. Typical performance as a function of current is on the following page.
2. Referenced from 10 MHz Gain (G_{P}).

INA-01170 Typical Scattering Parameters ($Z_{\text{O}} = 50 \Omega$, $T_{\text{A}} = 25^{\circ}\text{C}$, $I_{\text{d}} = 35 \text{ mA}$)

Freq. GHz	S_{11}		S_{21}			S_{12}			S_{22}		k
	Mag	Ang	dB	Mag	Ang	dB	Mag	Ang	Mag	Ang	
0.01	.09	-20	32.8	43.65	-2	-38.4	.012	-5	.17	-1	1.17
0.05	.10	-39	32.8	43.51	-9	-38.3	.012	17	.18	0	1.17
0.10	.13	-65	32.6	42.82	-18	-38.3	.012	-4	.18	1	1.17
0.15	.17	-83	32.4	41.71	-26	-38.4	.012	17	.19	2	1.18
0.20	.21	-96	32.1	40.41	-35	-38.6	.012	12	.19	3	1.18
0.25	.25	-107	31.8	38.93	-43	-39.0	.011	26	.19	4	1.26
0.30	.28	-115	31.5	37.38	-50	-39.0	.011	3	.20	5	1.26
0.40	.33	-130	30.7	34.19	-65	-39.3	.011	21	.21	3	1.31
0.50	.37	-140	29.9	31.13	-78	-39.2	.011	11	.22	0	1.35
0.60	.40	-150	29.0	28.30	-90	-38.9	.011	22	.23	-5	1.43
0.80	.43	-164	27.4	23.48	-112	-38.5	.012	30	.24	-19	1.52
1.0	.44	-176	25.8	19.45	-132	-36.5	.015	32	.23	-32	1.49
1.5	.44	165	21.8	12.37	-179	-33.6	.020	42	.19	-69	1.75
2.0	.44	154	17.9	7.88	146	-33.0	.022	42	.13	-106	2.42
2.5	.46	148	14.6	5.36	121	-30.6	.029	36	.12	-151	2.63
3.0	.48	139	11.4	3.71	96	-30.0	.032	45	.10	159	3.31

INA-01170 Typical Performance, $T_A = 25^\circ\text{C}$
(unless otherwise noted)

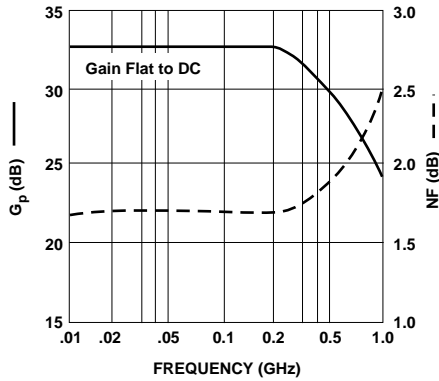

Figure 1. Typical Gain and Noise Figure vs. Frequency, $T_A = 25^\circ\text{C}$, $I_d = 35\text{ mA}$.

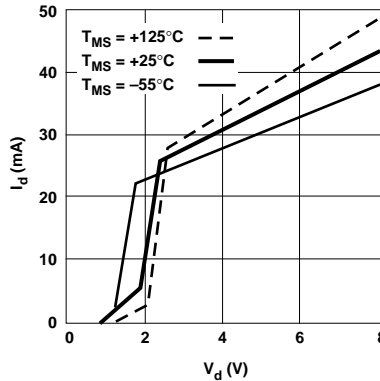

Figure 2. Device Current vs. Voltage.

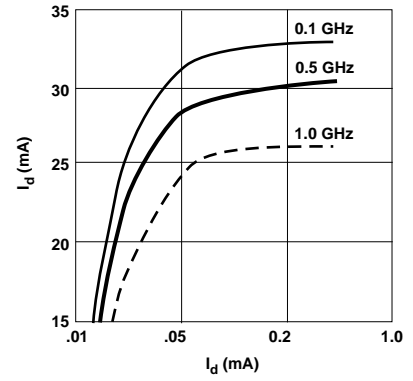

Figure 3. Power Gain vs. Current.

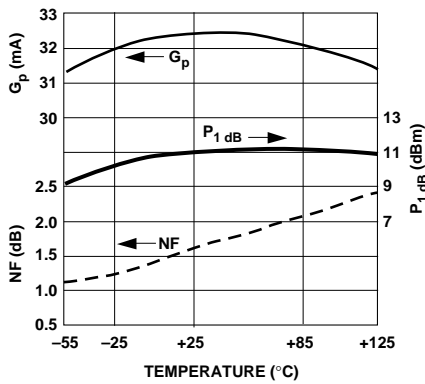

Figure 4. Output Power and 1 dB Gain Compression, NF and Power Gain vs. Case Temperature, $f = 0.1\text{ GHz}$, $I_d = 35\text{ mA}$.

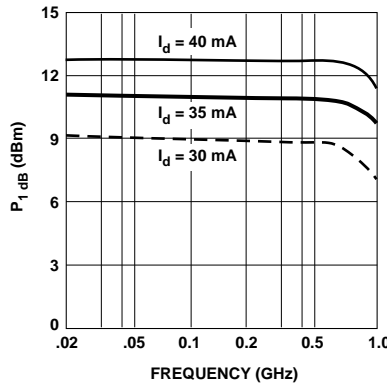

Figure 5. Output Power at 1 dB Gain Compression vs. Frequency.

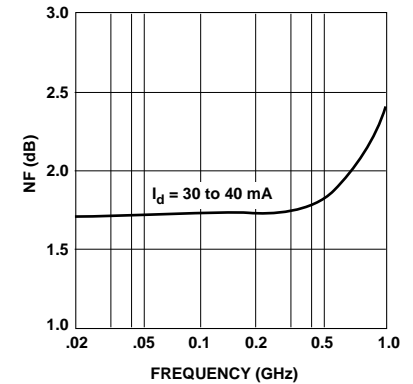
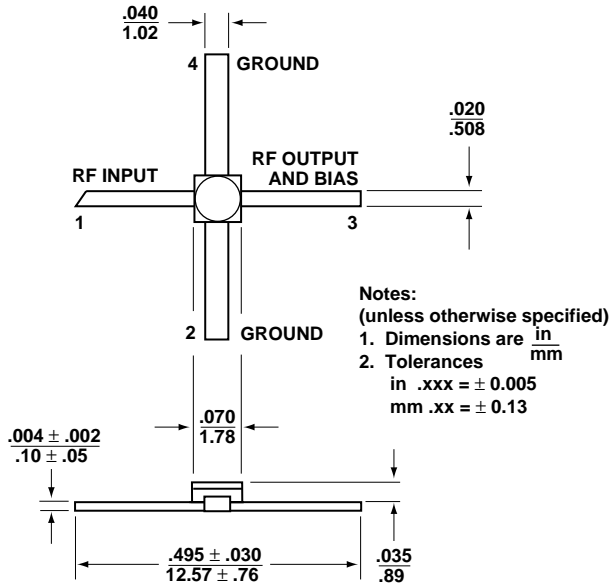

Figure 6. Noise Figure vs. Frequency.

70 mil Package Dimensions



www.hp.com/go/rf

For technical assistance or the location of your nearest Hewlett-Packard sales office, distributor or representative call:

Americas/Canada: 1-800-235-0312 or 408-654-8675

Far East/Australasia: Call your local HP sales office.

Japan: (81 3) 3335-8152

Europe: Call your local HP sales office.

Data subject to change.
Copyright © 1998 Hewlett-Packard Co.

Obsoletes 5965-9562E
Printed in U.S.A. 5966-4967E (5/98)