

1 GHz Low Noise Silicon MMIC Amplifier

Technical Data

Features

- Internally Biased, Single 5 V Supply (17 mA)
- 19 dB Gain
- 3.6 dB NF
- Unconditionally Stable

Applications

- Amplifier for Cellular, Cordless, Special Mobile Radio, PCS, ISM, Wireless LAN, and TV Tuner Applications

SOT-143 Surface Mount Package

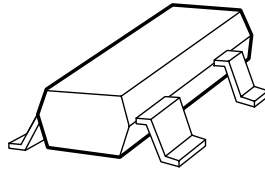

Pin Connections and Package Marking

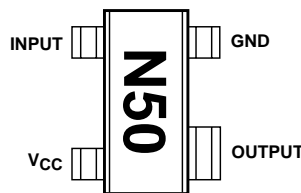

Equivalent Circuit (Simplified)

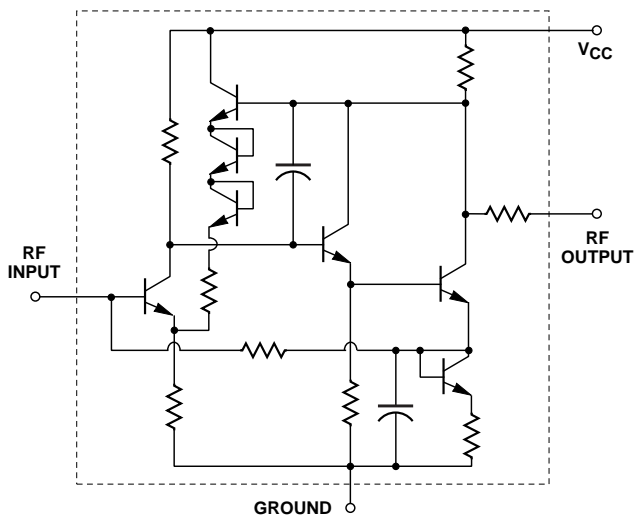

INA-50311

Description

Hewlett-Packard's INA-50311 is a Silicon monolithic amplifier that offers excellent gain and noise figure for applications to 1.0 GHz. Packaged in a miniature SOT-143 package, it requires very little board space.

The INA-50311 uses a topology which is internally biased, eliminating the need for external components and providing decreased sensitivity to ground inductance.

The INA-50311 is fabricated using HP's 30 GHz f_{MAX} ISOSAT™ Silicon bipolar process which uses nitride self-alignment sub-micrometer lithography, trench isolation, ion implantation, gold metallization, and polyimide intermetal dielectric and scratch protection to achieve superior performance, uniformity, and reliability.

Absolute Maximum Ratings

Symbol	Parameter	Units	Absolute Maximum ^[1]
V _{CC}	Device Voltage, to ground	V	12
P _{in}	CW RF Input Power	dBm	+13
T _j	Junction Temperature	°C	150
T _{STG}	Storage Temperature	°C	-65 to 150

Thermal Resistance^[2]:

$$\theta_{jc} = 550^{\circ}\text{C/W}$$

Notes:

1. Operation of this device above any one of these limits may cause permanent damage.
2. T_C = 25°C (T_C is defined to be the temperature at the package pins where contact is made to the circuit board).

INA-50311 Electrical Specifications^[3], T_C = 25°C, Z_O = 50 Ω, V_{CC} = 5 V

Symbol	Parameters and Test Conditions	Units	Min.	Typ.	Max.
G _p	Power Gain (S ₂₁ ²) f = 900 MHz	dB	16.5	19	
NF	Noise Figure f = 900 MHz	dB		3.6	
P _{1dB}	Output Power at 1 dB Gain Compression f = 900 MHz	dBm		0	
IP ₃	Third Order Intercept Point f = 900 MHz	dBm		+10	
VSWR	Input VSWR f = 900 MHz			1.5	
	Output VSWR f = 900 MHz			1.2	
I _{cc}	Device Current	mA		17	22
t _d	Group Delay f = 900 MHz	ps		320	

INA-50311 Typical Scattering Parameters^[3], T_C = 25°C, Z_O = 50 Ω, V_{CC} = 5 V

Freq. GHz	S ₁₁		S ₂₁			S ₁₂			S ₂₂		K Factor
	Mag	Ang	dB	Mag	Ang	dB	Mag	Ang	Mag	Ang	
0.05	0.12	-2	22.2	12.82	-6	-31.9	0.025	5	0.08	-11	1.68
0.10	0.12	-5	22.2	12.81	-12	-31.7	0.026	9	0.07	-24	1.63
0.20	0.12	-10	22.1	12.80	-24	-31.4	0.027	16	0.07	-44	1.59
0.30	0.14	-16	22.1	12.68	-36	-31.1	0.028	23	0.08	-62	1.55
0.40	0.15	-25	21.9	12.45	-49	-30.6	0.030	30	0.09	-78	1.48
0.50	0.16	-32	21.7	12.12	-61	-30.0	0.032	36	0.09	-94	1.44
0.60	0.17	-45	21.3	11.65	-74	-29.3	0.034	42	0.10	-107	1.42
0.70	0.18	-57	20.9	11.04	-87	-28.5	0.038	47	0.11	-120	1.36
0.80	0.19	-71	20.3	10.35	-99	-27.7	0.041	51	0.11	-131	1.35
0.90	0.19	-84	19.6	9.57	-111	-26.9	0.045	54	0.11	-141	1.34
1.00	0.20	-98	18.9	8.78	-122	-26.0	0.050	56	0.11	-149	1.32
1.20	0.21	-122	17.2	7.28	-143	-24.3	0.061	59	0.11	-163	1.31
1.40	0.21	-143	15.5	5.97	-161	-22.8	0.072	60	0.11	-172	1.33
1.60	0.21	-162	13.8	4.92	-176	-21.5	0.084	60	0.10	-179	1.37
1.80	0.22	-177	12.2	4.08	-169	-20.4	0.095	58	0.10	-175	1.42
2.00	0.22	170	10.7	3.43	157	-19.5	0.106	55	0.10	172	1.49
2.20	0.21	158	9.3	2.92	145	18.5	0.119	54	0.10	166	1.55
2.40	0.20	149	8.1	2.53	134	-17.9	0.127	50	0.11	163	1.65
2.50	0.20	146	7.5	2.37	129	-17.7	0.131	49	0.12	160	1.69

Note:

3. Reference plane per Figure 9 in Applications Information section.

INA-50311 Typical Performance, $T_C = 25^\circ\text{C}$, $Z_O = 50 \Omega$, $V_{CC} = 5 \text{ V}$

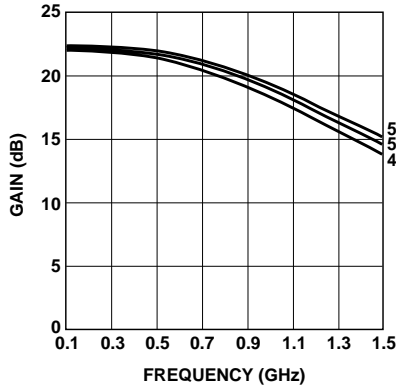

Figure 1. Power Gain vs. Frequency and Voltage.

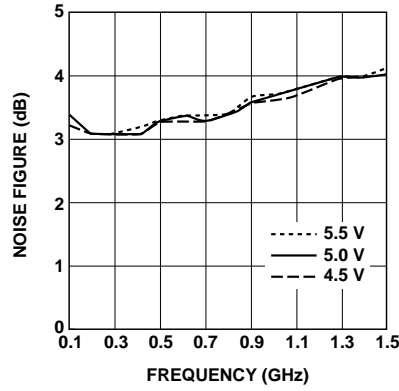

Figure 2. Noise Figure vs. Frequency and Voltage.

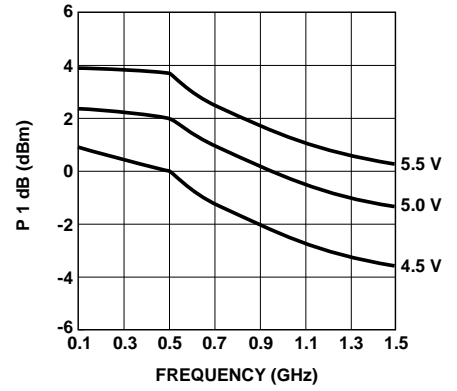

Figure 3. Output Power for 1 dB Gain Compression vs. Frequency and Voltage.

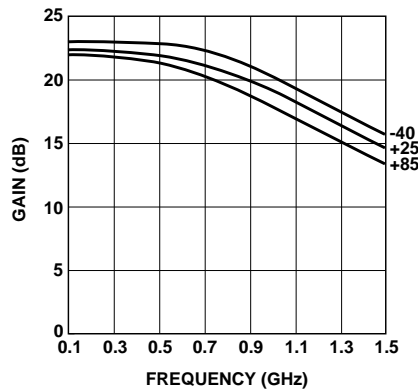

Figure 4. Gain vs. Frequency and Temperature.

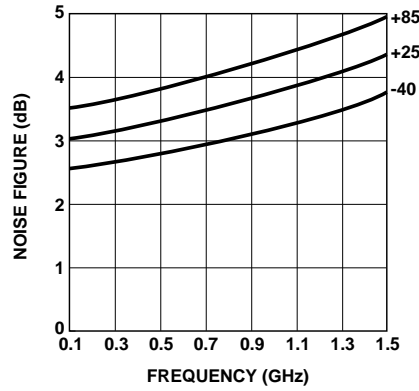

Figure 5. Noise Figure vs. Frequency and Temperature.

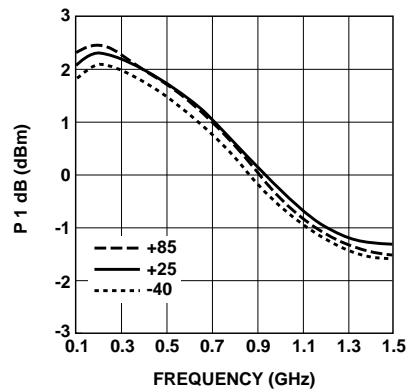

Figure 6. Output Power for 1 dB Gain Compression vs. Frequency and Temperature.

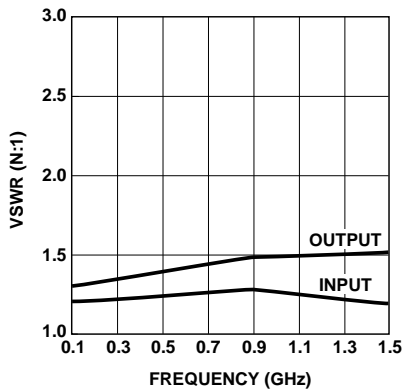

Figure 7. Input and Output VSWR vs. Frequency.

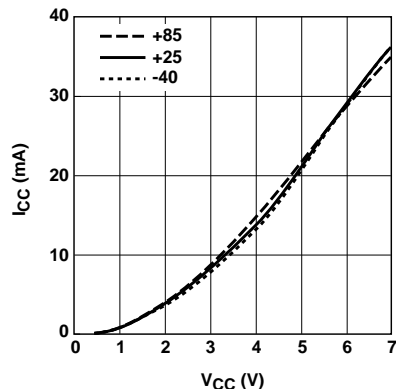

Figure 8. Supply Current vs. Voltage and Temperature.

INA-50311 Applications Information

Introduction

INA-50311 is a silicon RF integrated circuit amplifier with a $50\ \Omega$ input and output. The INA-50311 uses resistive feedback to provide flat gain for low noise or multi-purpose gain block applications up to 1000 MHz.

Phase Reference Planes

The positions of the reference planes used to measure S-Parameters are shown in Figure 9. As seen in the illustration, the reference planes are located at the point where the package leads contact the test circuit.

Biasing

The INA-50311 is a voltage biased device and operates from a single +5 volt power supply with a current drain of only 17 mA. All bias circuitry is fully integrated into the IC eliminating the need for external DC components. The supply voltage for the INA-50311 is fed in through a separate V_{CC} pin of the device and does not require RF isolation from the input or output signal connections.

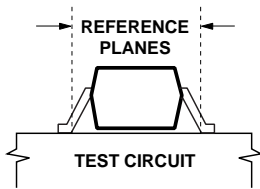

Figure 9. Reference Planes.

Operating Details

The INA-50311 is very easy to use. The basic application of the INA-50311 is shown in Figure 10.

DC blocking capacitors are placed in series with the RF Input and RF Output to isolate adjacent circuits from the internal bias voltages that are present at these terminals. The values of the blocking capacitors are determined by the lowest operating frequency. The values for the blocking capacitors are chosen such that their reactances are small relative to $50\ \Omega$. As an example, use of the INA-50311 for an application covering the 902 to 928 MHz band would require blocking capacitors of at least 70 pF.

The V_{CC} connection to the amplifier must be RF bypassed by placing a capacitor to ground directly at the bias pin of the package. Like the DC blocking capacitors, the value of the V_{CC} bypass capacitor is determined by the lowest operating frequency for the amplifier. This value may typically be the same as that of the DC blocking capacitors. If long bias lines are used to connect the amplifier to the V_{CC}

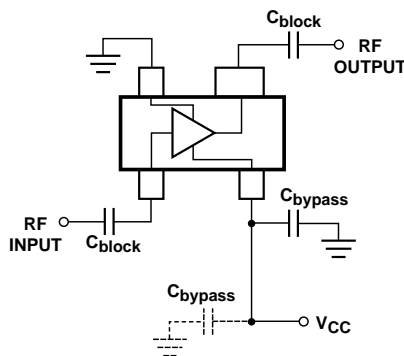

Figure 10. Basic Amplifier Application.

supply, additional bypass capacitors may be needed to prevent resonances that would otherwise result in undesirable gain responses. A well-bypassed V_{CC} line is also desirable to prevent possible oscillations that may occur due to feedback through the bias line from other stages in a cascade.

Adequate grounding is needed to obtain maximum performance. The ground pin of the INA-50311 should be connected directly to RF ground by using plated through holes (vias) near the package terminals.

FR-4 or G-10 PCB material is a good choice for most low cost wireless applications. Typical board thickness is 0.025 or 0.031 inches. The width of $50\ \Omega$ microstriplines in these PCB thicknesses is also convenient for mounting chip components such as the series DC blocking capacitors.

Circuit Example

The amplifier example in Figure 11 shows a typical implementation of the INA-50311. The input and output connections are through $50\ \Omega$ microstriplines with DC blocking capacitors.

The V_{CC} supply connection is RF bypassed very close to the lead of the RFIC. Provision is also made for an additional bypass capacitor on the V_{CC} line near the edge of the PCB.

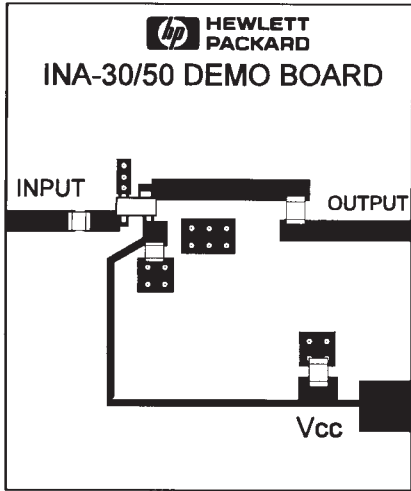
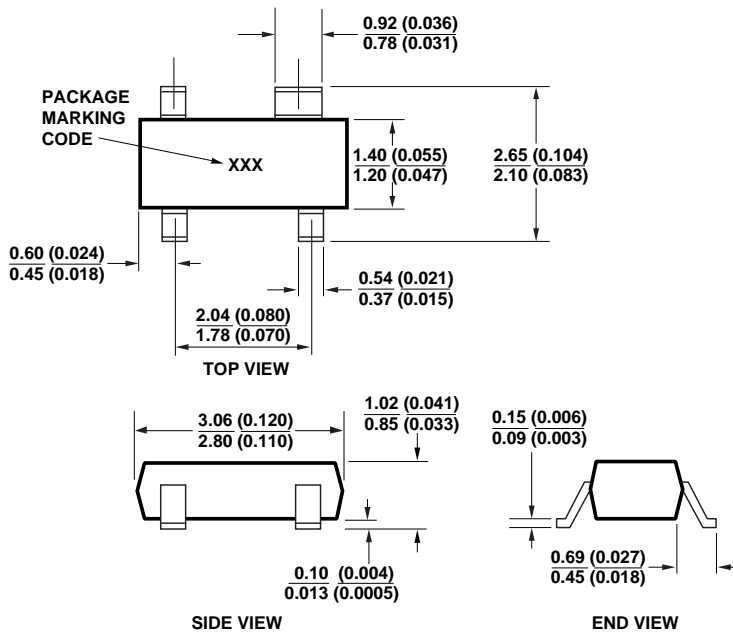

Figure 11. Application Example.

INA-50311 Part Number Ordering Information

Part Number	Devices per Container	Container
INA-50311-TR1	3,000	7" reel
INA-50311-BLK	100	Antistatic bag

Package Dimensions



DIMENSIONS ARE IN MILLIMETERS (INCHES)