

INJ0212AP1

High Speed Switching
Silicon P-channel MOSFET

DESCRIPTION

INJ0210AP1 is a Silicon P-channel MOSFET.

This product is most suitable for use such as portable machinery, because of low voltage drive and low on resistance.

FEATURE

- Input impedance is high, and not necessary to consider a drive electric current.
- High drain current $I_D = -2.5A$
- V_{th} is low, and drive by low voltage is possible. $V_{th} = 1.0 \sim 2.5V$
- Low on Resistance. $R_{DS(on)} = 95m\Omega$ (TYP).
- High speed switching.

APPLICATION

Switching

MAXIMUM RATING (Ta=25°C)

Symbol	Parameter	Rating	UNIT
VDSS	Drain-Source Voltage	-30	V
VGSS	Gate-Source Voltage	±20	V
ID(DC)	Drain Current (DC)	-2.5	A
IDP	Drain Current(Pulse) ※1	-5	A
PD	Total Power Dissipation	750(※2)	mW
Tch	Channel Temperature	150	°C
Tstg	Storage Temperature	-55~+150	°C

※1: $P_w \leq 10\mu s$, Duty cycle $\leq 1\%$

※2: package mounted on 9mm × 19mm × 1mm glass-epoxy substrate

OUTLINE DRAWING

UNIT: mm

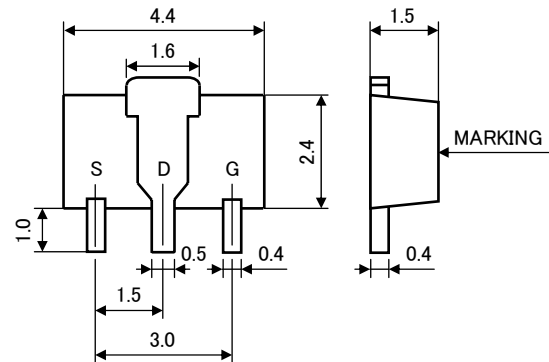

TERMINAL CONNECTOR

S: SOURCE

D: DRAIN

G: GATE

JEITA: SC-62

JEDEC: SOT-89

EQUIVALENT

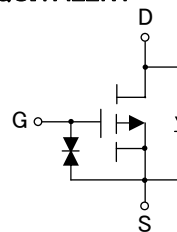

MARKING

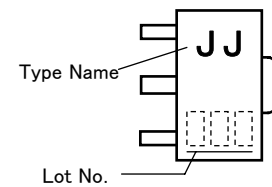

ELECTRICAL CHARACTERISTICS (Ta=25°C)

Parameter	Symbol	Test Condition	Limit			Unit
			MIN	TYP	MAX	
Drain-Source Breakdown Voltage	$V_{(BR)DSS}$	$I_D = -100\mu A, V_{GS} = 0V$	-30	-	-	V
Gate-Source Leak Current	I_{GSS}	$V_{GS} = \pm 20V, I_D = 0A$	-	-	±10	μA
Zero Gate Voltage Drain Current	I_{DSS}	$V_{DS} = -30V, V_{GS} = 0V$	-	-	-1	μA
Gate Threshold Voltage	V_{th}	$I_D = -250\mu A, V_{DS} = V_{GS}$	-1	-	-2.5	V
Forward Transfer Admittance	$ Y_{fs} $	$V_{DS} = -10V, I_D = -1.2A$	-	3.0	-	S
Static Drain-Source On-State Resistance	$R_{DS(on)}$	$I_D = -0.5A, V_{GS} = -4.5V$	-	120	-	mΩ
		$I_D = -0.5A, V_{GS} = -10V$	-	95	-	
Input Capacitance	C_{iss}	$V_{DS} = -10V, V_{GS} = 0V, f = 1MHz$	-	500	-	pF
Output Capacitance	C_{oss}		-	100	-	
Switching Time	t_{on}	$V_{DD} = -10V, I_D = -2.5A, V_{GS} = 0 \sim -5V$	-	35	-	ns
	t_{off}		-	50	-	

INJ0212AP1

High Speed Switching
Silicon P-channel MOSFET

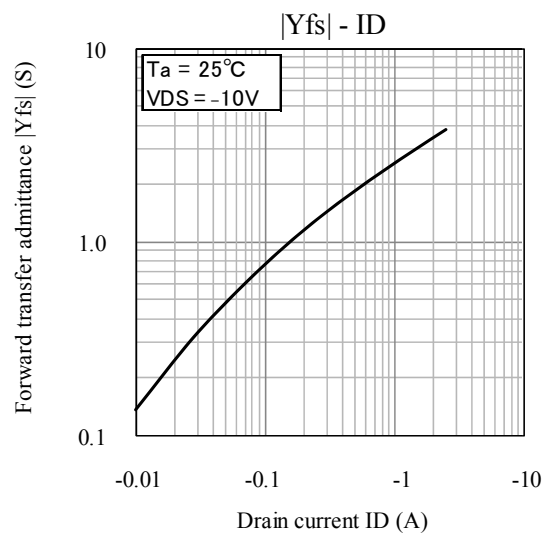
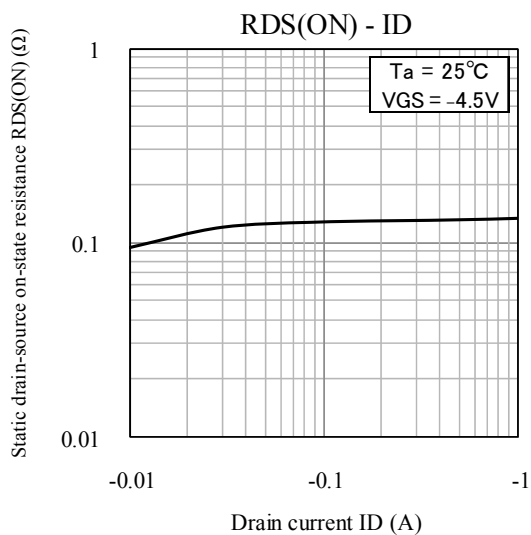
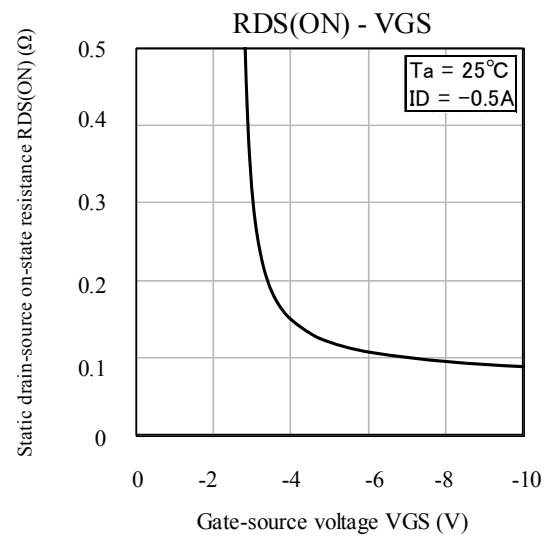
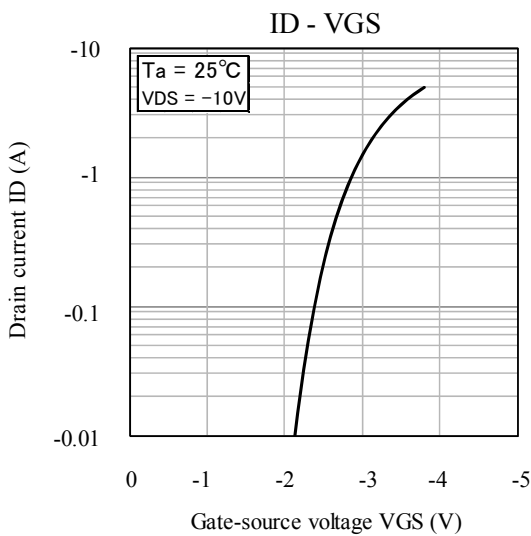
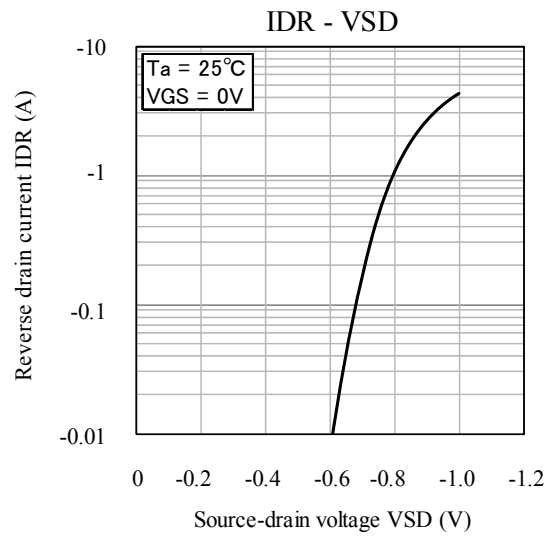
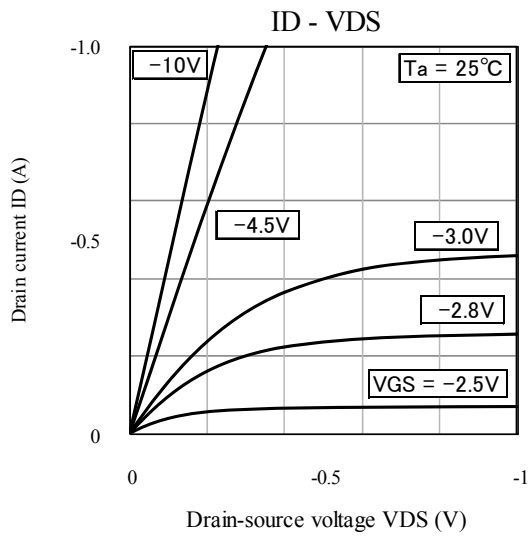

INJ0212AP1

High Speed Switching
Silicon P-channel MOSFET

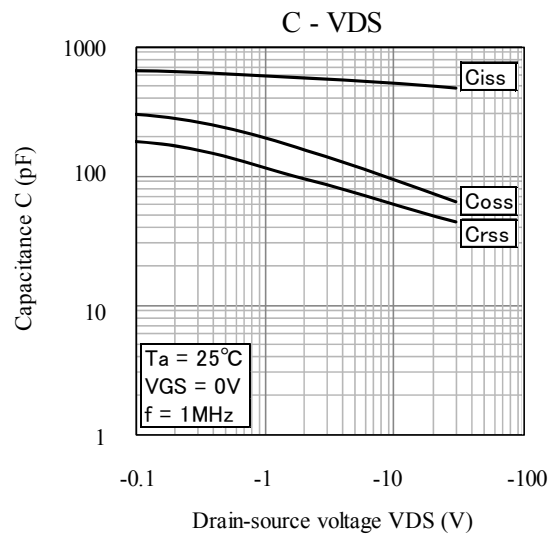
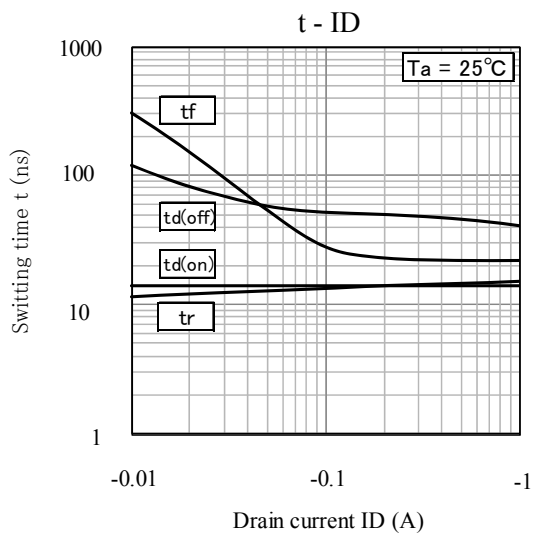
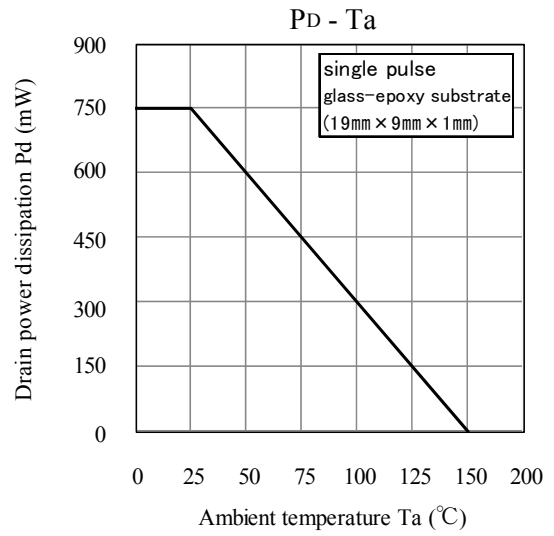
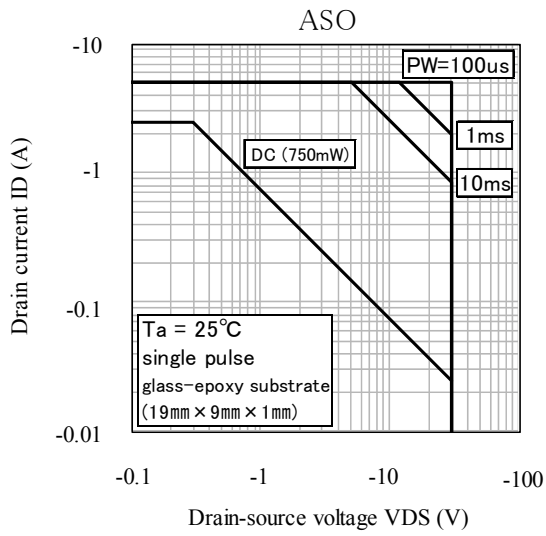

Test circuit

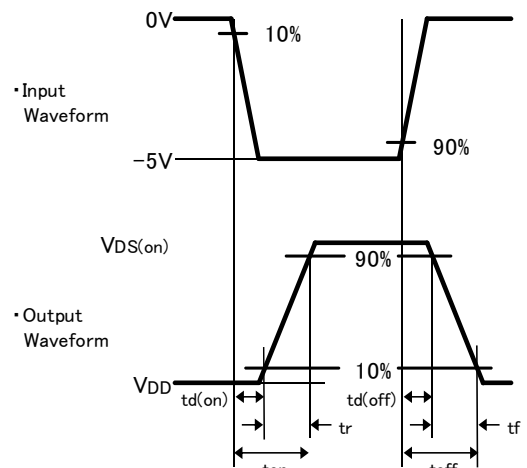
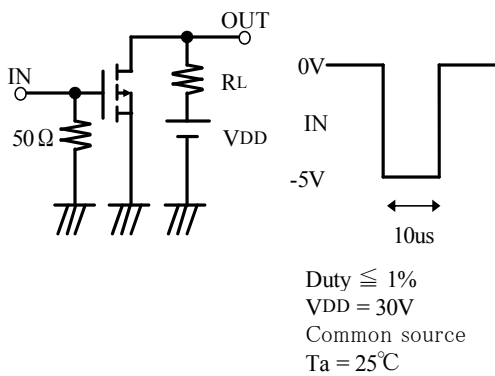



6-41 Tsukuba, Isahaya, Nagasaki, 854-0065 Japan

Keep safety first in your circuit designs!

•ISAHAYA Electronics Corporation puts the maximum effort into making semiconductor products better and more reliable, but there is always the possibility that trouble may occur with them. Trouble with semiconductors may lead to personal injury, fire or property damage. Remember to give due consideration to safety when making your circuit designs, with appropriate measures such as (1) placement of substitutive, auxiliary, (2) use of non-flammable material or (3) prevention against any malfunction or mishap.

Notes regarding these materials

- These materials are intended as a reference to our customers in the selection of the ISAHAYA products best suited to the customer's application; they don't convey any license under any intellectual property rights, or any other rights, belonging ISAHAYA or third party.
- ISAHAYA Electronics Corporation assumes no responsibility for any damage, or infringement of any third party's rights, originating in the use of any product data, diagrams, charts or circuit application examples contained in these materials.
- All information contained in these materials, including product data, diagrams and charts, represent information on products at the time of publication of these materials, and are subject to change by ISAHAYA Electronics Corporation without notice due to product improvements or other reasons. It is therefore recommended that customers contact ISAHAYA Electronics Corporation or an authorized ISAHAYA products distributor for the latest product information before purchasing product listed herein.
- ISAHAYA Electronics Corporation products are not designed or manufactured for use in a device or system that is used under circumstances in which human life is potentially at stake. Please contact ISAHAYA electronics corporation or an authorized ISAHAYA products distributor when considering the use of a product contained herein for any specific purposes, such as apparatus or systems for transportation, vehicular, medical, aerospace, nuclear, or undersea repeater use.
- The prior written approval of ISAHAYA Electronics Corporation is necessary to reprint or reproduce in whole or in part these materials.
- If these products or technologies are subject to the Japanese export control restrictions, they must be exported under a license from the Japanese government and cannot be imported into a country other than the approved destination. Any diversion or re-export contrary to the export control laws and regulations of Japan and/or the country of destination is prohibited.
- Please contact ISAHAYA Electronics Corporation or authorized ISAHAYA products distributor for further details on these materials or the products contained therein.