

MOSFET

700V CoolMOS™ CE Power Transistor

CoolMOS™ is a revolutionary technology for high voltage power MOSFETs, designed according to the superjunction (SJ) principle and pioneered by Infineon Technologies. CoolMOS™ CE is a price-performance optimized platform enabling to target cost sensitive applications in Consumer and Lighting markets by still meeting highest efficiency standards. The new series provides all benefits of a fast switching Superjunction MOSFET while not sacrificing ease of use and offering the best cost down performance ratio available on the market.

PG - TO220 FullPAK WideCreepage



Features

- Extremely low losses due to very low FOM $R_{DS(on)} \cdot Q_g$ and Eoss
- Very high commutation ruggedness
- Easy to use/drive
- Pb-free plating, Halogen free mold compound
- Qualified for standard grade applications

Applications

Adapter, LCD & PDP TV and Indoor lighting

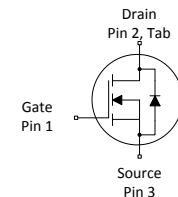

Table 1 Key Performance Parameters

| Parameter | Value | Unit |
|----------------------|-------|------|
| $V_{DS} @ T_{j,max}$ | 750 | V |
| $R_{DS(on),max}$ | 950 | mΩ |
| $Q_{g,typ}$ | 15.3 | nC |
| I_d | 7.4 | A |
| $I_{D,pulse}$ | 12 | A |
| $E_{oss}@400V$ | 1.5 | μJ |



| Type / Ordering Code | Package | Marking | Related Links |
|----------------------|---------------------------------|----------|----------------|
| IPAW70R950CE | PG - TO220 FullPAK WideCreepage | 70S950CE | see Appendix A |

Table of Contents

| | |
|---|----|
| Description | 1 |
| Maximum ratings | 3 |
| Thermal characteristics | 4 |
| Electrical characteristics | 5 |
| Electrical characteristics diagrams | 7 |
| Test Circuits | 11 |
| Package Outlines | 12 |
| Appendix A | 13 |
| Revision History | 14 |
| Trademarks | 14 |
| Disclaimer | 14 |

1 Maximum ratings

at $T_j = 25^\circ\text{C}$, unless otherwise specified

Table 2 Maximum ratings

| Parameter | Symbol | Values | | | Unit | Note / Test Condition |
|---|---------------------|--------|------|------------|------------------|---|
| | | Min. | Typ. | Max. | | |
| Continuous drain current ¹⁾ | I_D | - | - | 7.4 4.7 | A | $T_C=25^\circ\text{C}$ $T_C=100^\circ\text{C}$ |
| Pulsed drain current ²⁾ | $I_{D,pulse}$ | - | - | 12 | A | $T_C=25^\circ\text{C}$ |
| Avalanche energy, single pulse | E_{AS} | - | - | 50 | mJ | $I_D=1\text{A}$; $V_{DD}=50\text{V}$; see table 10 |
| Avalanche energy, repetitive | E_{AR} | - | - | 0.15 | mJ | $I_D=1\text{A}$; $V_{DD}=50\text{V}$; see table 10 |
| Avalanche current, repetitive | I_{AR} | - | - | 1.0 | A | - |
| MOSFET dv/dt ruggedness | dv/dt | - | - | 50 | V/ns | $V_{DS}=0\dots480\text{V}$ |
| Gate source voltage (static) | V_{GS} | -20 | - | 20 | V | static; |
| Gate source voltage (dynamic) | V_{GS} | -30 | - | 30 | V | AC ($f>1\text{ Hz}$) |
| Power dissipation (TO252) | P_{tot} | - | - | 68 | W | $T_C=25^\circ\text{C}$ |
| Storage temperature | T_{stg} | -40 | - | 150 | $^\circ\text{C}$ | - |
| Operating junction temperature | T_j | -40 | - | 150 | $^\circ\text{C}$ | - |
| Continuous diode forward current | I_S | - | - | 5.2 | A | $T_C=25^\circ\text{C}$ |
| Diode pulse current ²⁾ | $I_{S,pulse}$ | - | - | 12 | A | $T_C=25^\circ\text{C}$ |
| Reverse diode dv/dt ³⁾ | dv/dt | - | - | 15 | V/ns | $V_{DS}=0\dots400\text{V}$, $I_{SD}\leq I_S$, $T_j=25^\circ\text{C}$ see table 8 |
| Maximum diode commutation speed | di _f /dt | - | - | 500 | A/ μs | $V_{DS}=0\dots400\text{V}$, $I_{SD}\leq I_S$, $T_j=25^\circ\text{C}$ see table 8 |
| Power dissipation (FullPAK) TO-220 | P_{tot} | - | - | 33 | W | - |
| Insulation withstand voltage for TO-220FP | V_{ISO} | - | - | 2500 | V | V_{rms} , $T_C=25^\circ\text{C}$, $t=1\text{min}$ |

¹⁾ Limited by $T_{j,max}$. Maximum duty cycle $D=0.5$, TO252 equivalent

²⁾ Pulse width t_p limited by $T_{j,max}$

³⁾ Identical low side and high side switch with identical R_G

2 Thermal characteristics

Table 3 Thermal characteristics (Full PAK)

| Parameter | Symbol | Values | | | Unit | Note / Test Condition |
|--|------------|--------|------|------|------|-------------------------------------|
| | | Min. | Typ. | Max. | | |
| Thermal resistance, junction - case | R_{thJC} | - | - | 3.8 | °C/W | - |
| Thermal resistance, junction - ambient | R_{thJA} | - | - | 80 | °C/W | leaded |
| Soldering temperature, wavesoldering only allowed at leads | T_{sold} | - | - | 260 | °C | 1.6mm (0.063 in.) from case for 10s |

3 Electrical characteristics

at $T_j=25^\circ\text{C}$, unless otherwise specified

Table 4 Static characteristics

| Parameter | Symbol | Values | | | Unit | Note / Test Condition |
|----------------------------------|---------------|--------|------|------|---------------|---|
| | | Min. | Typ. | Max. | | |
| Drain-source breakdown voltage | $V_{(BR)DSS}$ | 700 | - | - | V | $V_{GS}=0V, I_D=1mA$ |
| Gate threshold voltage | $V_{(GS)th}$ | 2.5 | 3.0 | 3.5 | V | $V_{DS}=V_{GS}, I_D=0.15mA$ |
| Zero gate voltage drain current | I_{DSS} | - | - | 1 | μA | $V_{DS}=700V, V_{GS}=0V, T_j=25^\circ\text{C}$ $V_{DS}=700V, V_{GS}=0V, T_j=150^\circ\text{C}$ |
| Gate-source leakage current | I_{GSS} | - | - | 100 | nA | $V_{GS}=20V, V_{DS}=0V$ |
| Drain-source on-state resistance | $R_{DS(on)}$ | - | 0.86 | 0.95 | Ω | $V_{GS}=10V, I_D=1.5A, T_j=25^\circ\text{C}$ $V_{GS}=10V, I_D=1.5A, T_j=150^\circ\text{C}$ |
| Gate resistance | R_G | - | 5.5 | - | Ω | $f=1\text{MHz}$, open drain |

Table 5 Dynamic characteristics

| Parameter | Symbol | Values | | | Unit | Note / Test Condition |
|--|--------------|--------|------|------|------|--|
| | | Min. | Typ. | Max. | | |
| Input capacitance | C_{iss} | - | 328 | - | pF | $V_{GS}=0V, V_{DS}=100V, f=1\text{MHz}$ |
| Output capacitance | C_{oss} | - | 23 | - | pF | $V_{GS}=0V, V_{DS}=100V, f=1\text{MHz}$ |
| Effective output capacitance, energy related ¹⁾ | $C_{o(er)}$ | - | 14 | - | pF | $V_{GS}=0V, V_{DS}=0\dots480V$ |
| Effective output capacitance, time related ²⁾ | $C_{o(tr)}$ | - | 58.5 | - | pF | $I_D=\text{constant}, V_{GS}=0V, V_{DS}=0\dots480V$ |
| Turn-on delay time | $t_{d(on)}$ | - | 6.6 | - | ns | $V_{DD}=400V, V_{GS}=13V, I_D=2.2A,$ $R_G=10.2\Omega$; see table 9 |
| Rise time | t_r | - | 5.2 | - | ns | $V_{DD}=400V, V_{GS}=13V, I_D=2.2A,$ $R_G=10.2\Omega$; see table 9 |
| Turn-off delay time | $t_{d(off)}$ | - | 41 | - | ns | $V_{DD}=400V, V_{GS}=13V, I_D=2.2A,$ $R_G=10.2\Omega$; see table 9 |
| Fall time | t_f | - | 13.6 | - | ns | $V_{DD}=400V, V_{GS}=13V, I_D=2.2A,$ $R_G=10.2\Omega$; see table 9 |

Table 6 Gate charge characteristics

| Parameter | Symbol | Values | | | Unit | Note / Test Condition |
|-----------------------|---------------|--------|------|------|------|--|
| | | Min. | Typ. | Max. | | |
| Gate to source charge | Q_{GS} | - | 1.8 | - | nC | $V_{DD}=480V, I_D=2.2A, V_{GS}=0$ to 10V |
| Gate to drain charge | Q_{gd} | - | 8 | - | nC | $V_{DD}=480V, I_D=2.2A, V_{GS}=0$ to 10V |
| Gate charge total | Q_g | - | 15.3 | - | nC | $V_{DD}=480V, I_D=2.2A, V_{GS}=0$ to 10V |
| Gate plateau voltage | $V_{plateau}$ | - | 5.4 | - | V | $V_{DD}=480V, I_D=2.2A, V_{GS}=0$ to 10V |

¹⁾ $C_{o(er)}$ is a fixed capacitance that gives the same stored energy as C_{oss} while V_{DS} is rising from 0 to 480V

²⁾ $C_{o(tr)}$ is a fixed capacitance that gives the same charging time as C_{oss} while V_{DS} is rising from 0 to 480V

Table 7 Reverse diode characteristics

| Parameter | Symbol | Values | | | Unit | Note / Test Condition |
|-------------------------------|-----------|--------|------|------|---------|---|
| | | Min. | Typ. | Max. | | |
| Diode forward voltage | V_{SD} | - | 0.9 | - | V | $V_{GS}=0V, I_F=2.2A, T_j=25^\circ C$ |
| Reverse recovery time | t_{rr} | - | 226 | - | ns | $V_R=400V, I_F=2.2A, di_F/dt=100A/\mu s$; see table 8 |
| Reverse recovery charge | Q_{rr} | - | 1.3 | - | μC | $V_R=400V, I_F=2.2A, di_F/dt=100A/\mu s$; see table 8 |
| Peak reverse recovery current | I_{rrm} | - | 9.9 | - | A | $V_R=400V, I_F=2.2A, di_F/dt=100A/\mu s$; see table 8 |

4 Electrical characteristics diagrams

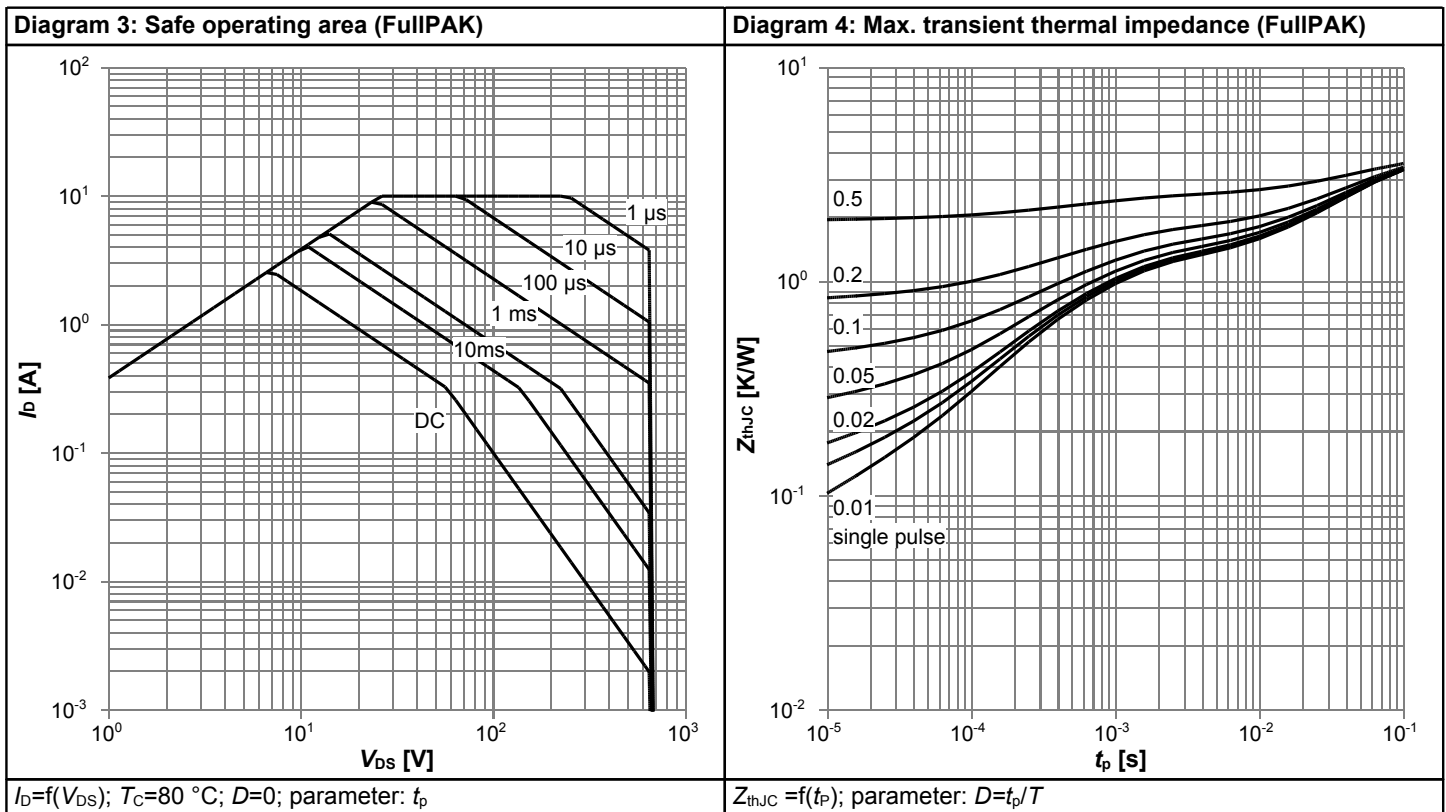
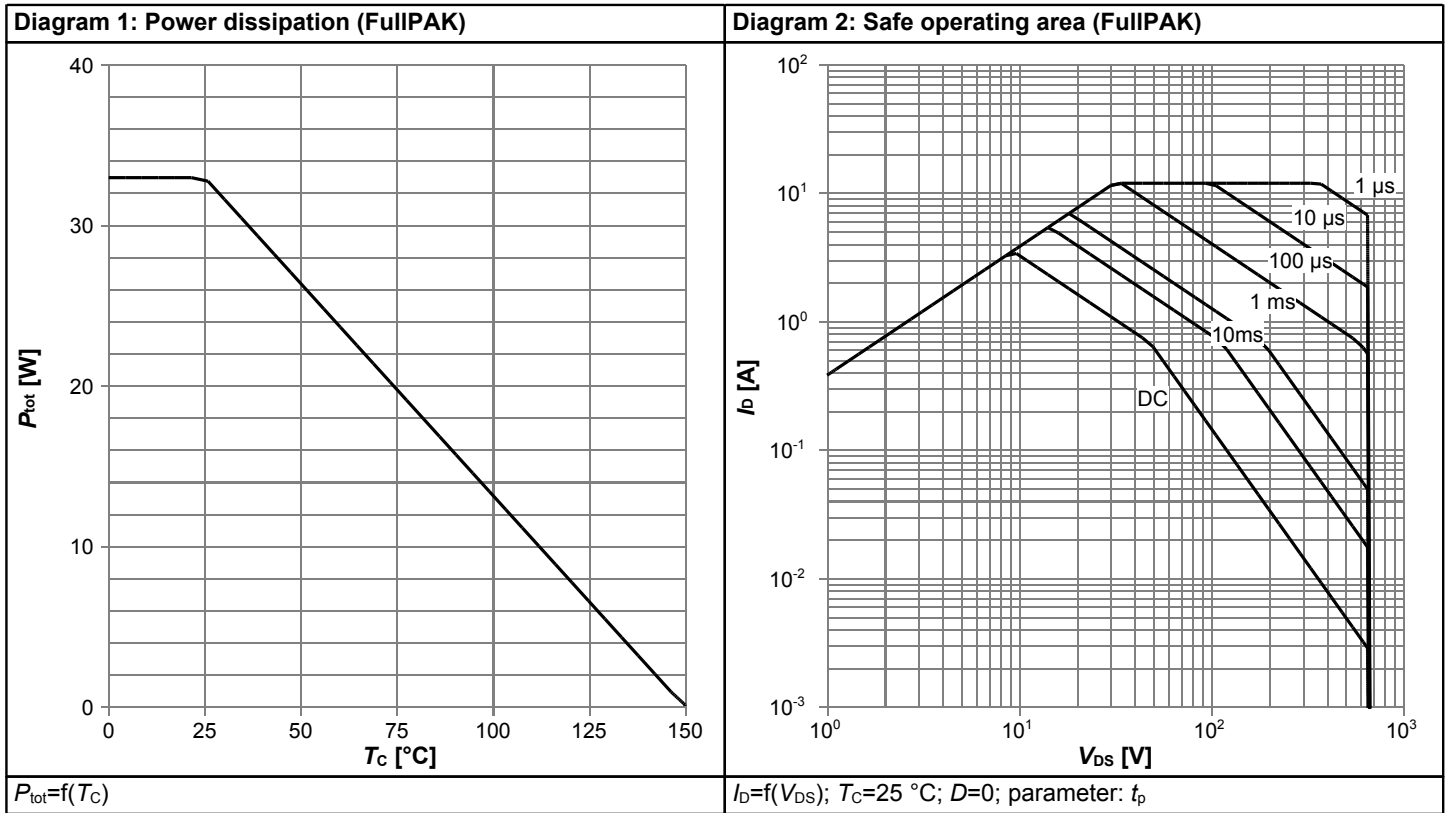

700V CoolMOS™ CE Power Transistor

IPAW70R950CE

Diagram 5: Typ. output characteristics

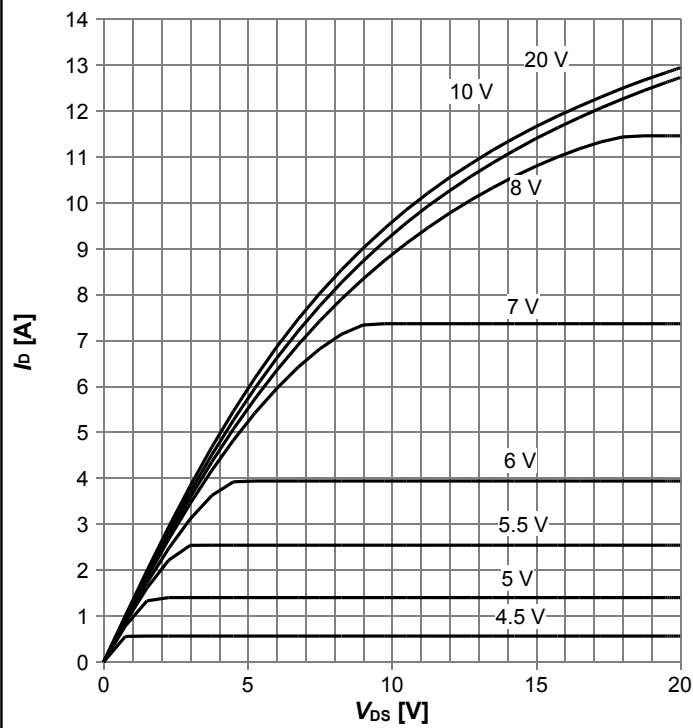

$I_D=f(V_{DS}); T_j=25\text{ }^\circ\text{C};$ parameter: V_{GS}

Diagram 6: Typ. output characteristics

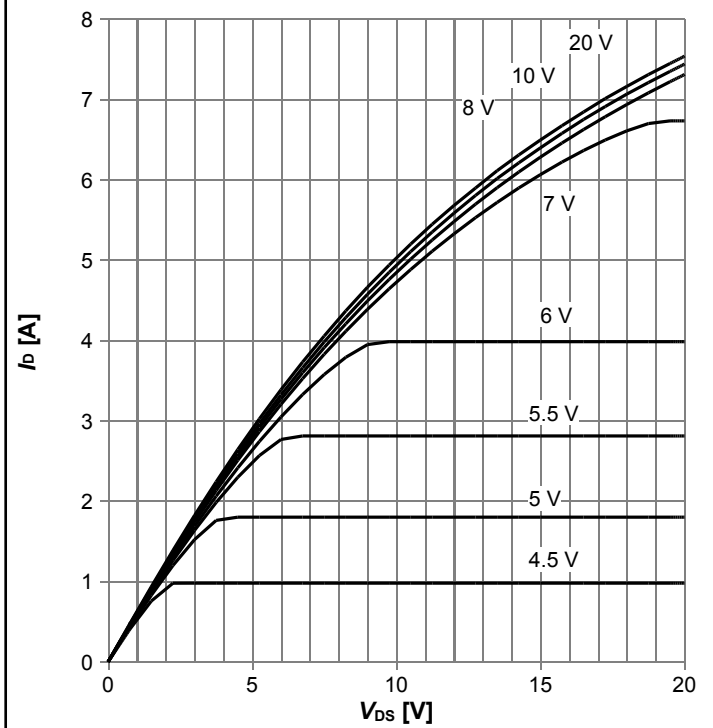

$I_D=f(V_{DS}); T_j=125\text{ }^\circ\text{C};$ parameter: V_{GS}

Diagram 7: Typ. drain-source on-state resistance

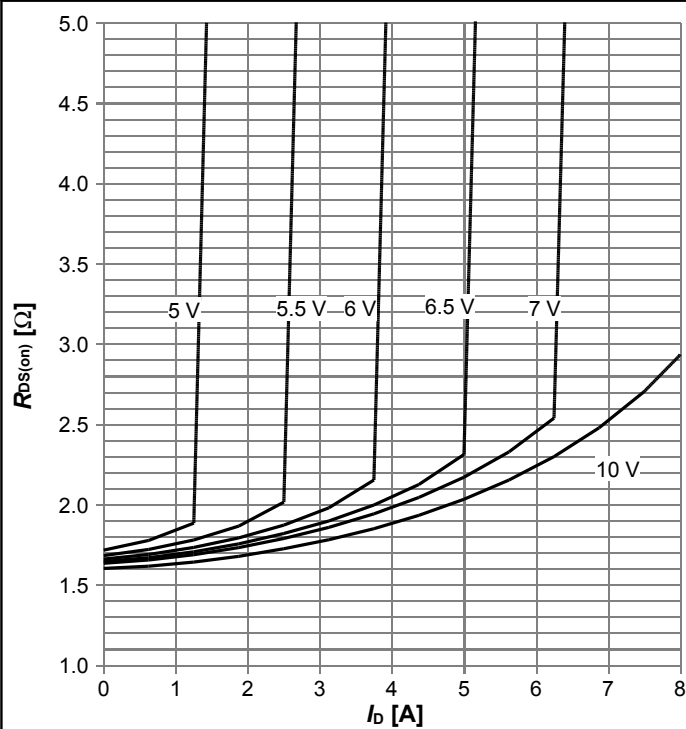

$R_{DS(on)}=f(I_D); T_j=125\text{ }^\circ\text{C};$ parameter: V_{GS}

Diagram 8: Drain-source on-state resistance

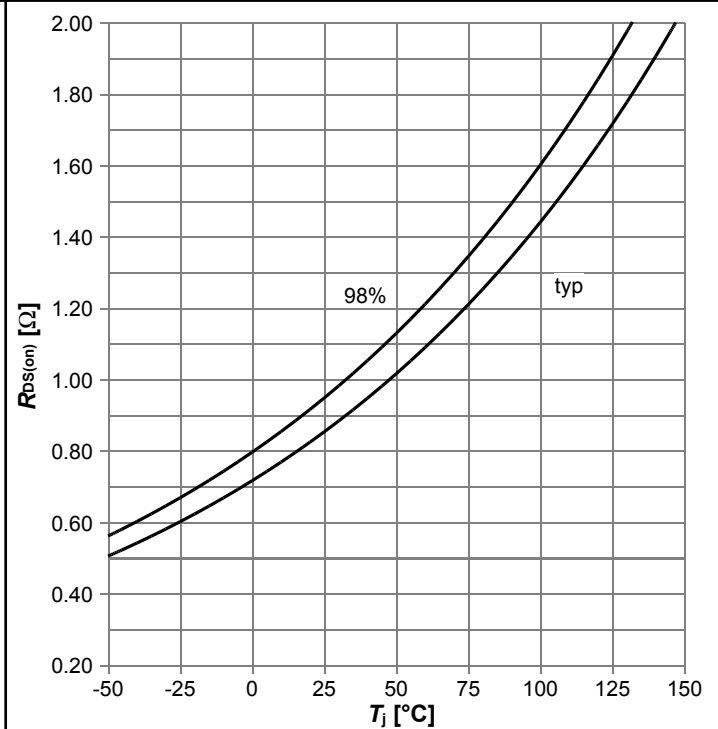

$R_{DS(on)}=f(T_j); I_D=1.5\text{ A}; V_{GS}=10\text{ V}$

Diagram 9: Typ. transfer characteristics

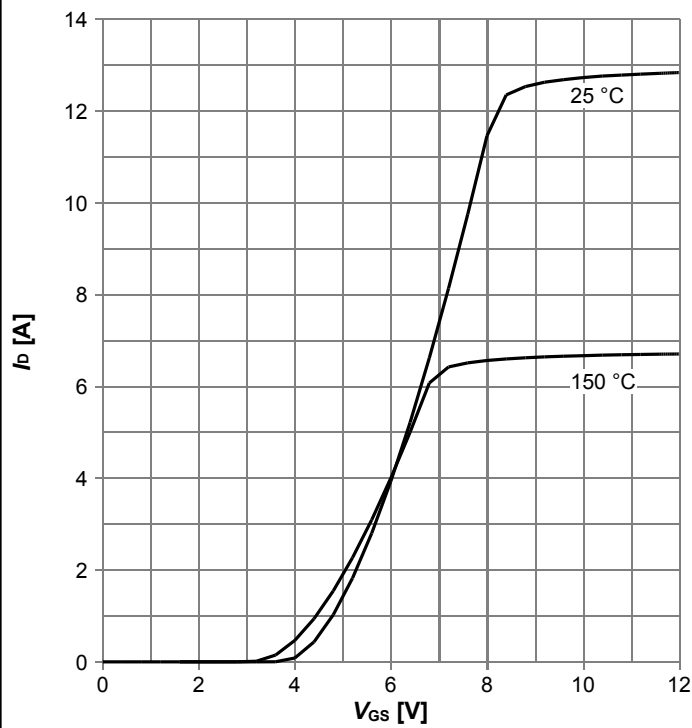

$I_D = f(V_{GS}); V_{DS} = 20V; \text{parameter: } T_j$

Diagram 10: Typ. gate charge

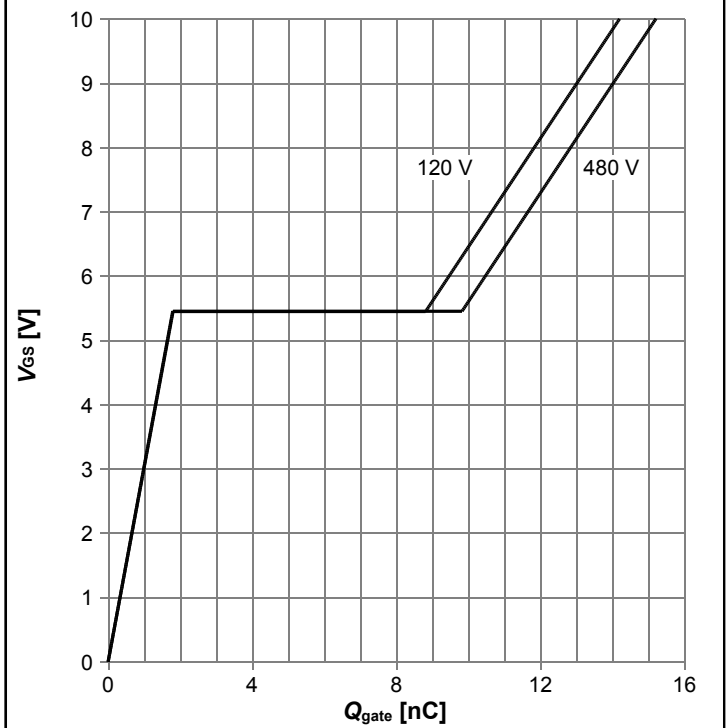

$V_{GS} = f(Q_{gate}); I_D = 2.2 \text{ A pulsed}; \text{parameter: } V_{DD}$

Diagram 11: Forward characteristics of reverse diode

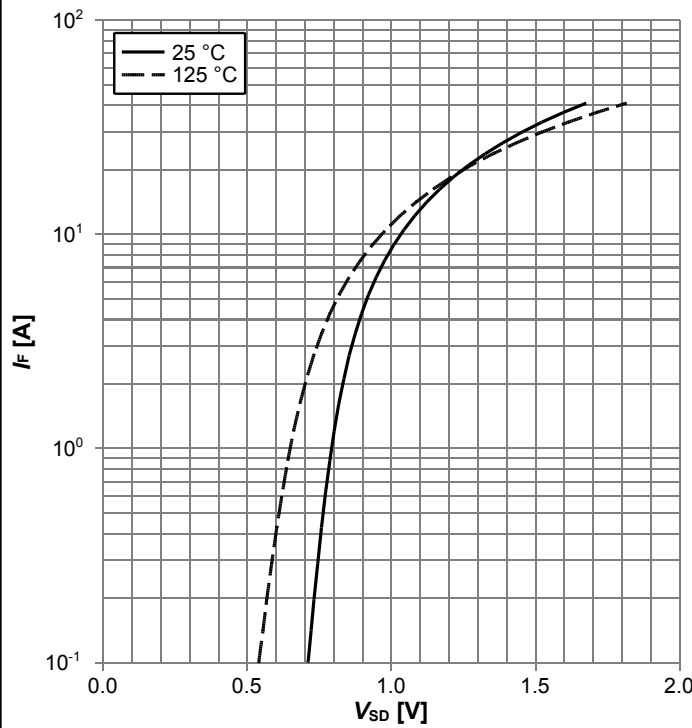

$I_F = f(V_{SD}); \text{parameter: } T_j$

Diagram 12: Avalanche energy

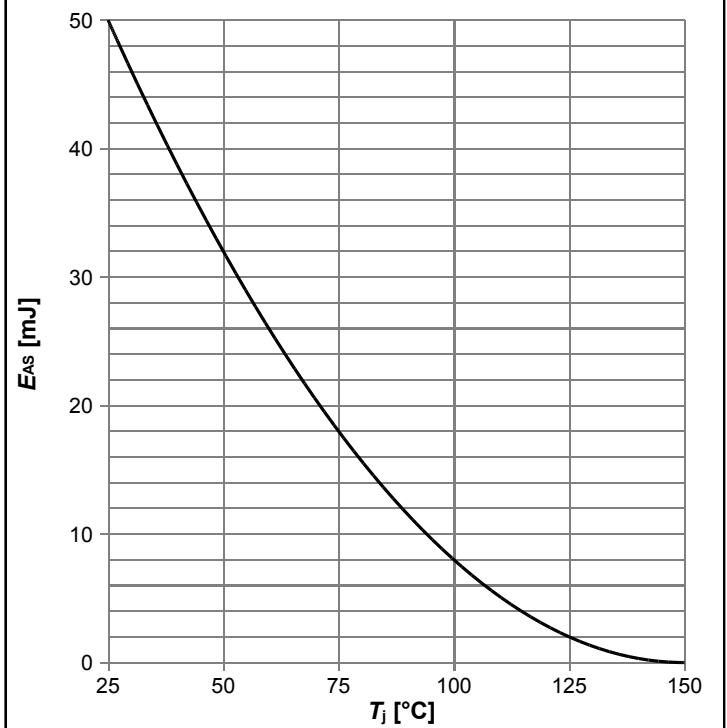

$E_{AS} = f(T_j); I_D = 1.0 \text{ A}; V_{DD} = 50 \text{ V}$

700V CoolMOS™ CE Power Transistor
IPAW70R950CE

Diagram 13: Drain-source breakdown voltage

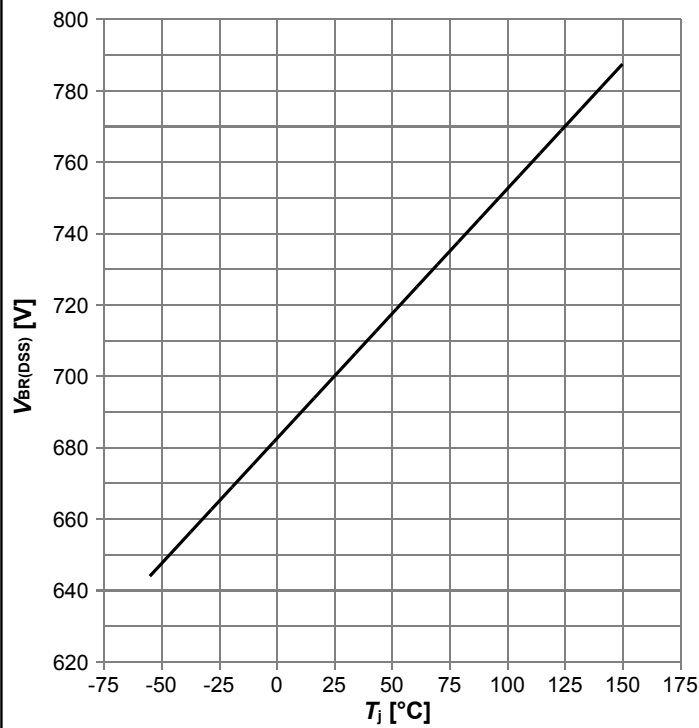

$V_{BR(DSS)}=f(T_j); I_D=1.0 \text{ mA}$

Diagram 14: Typ. capacitances

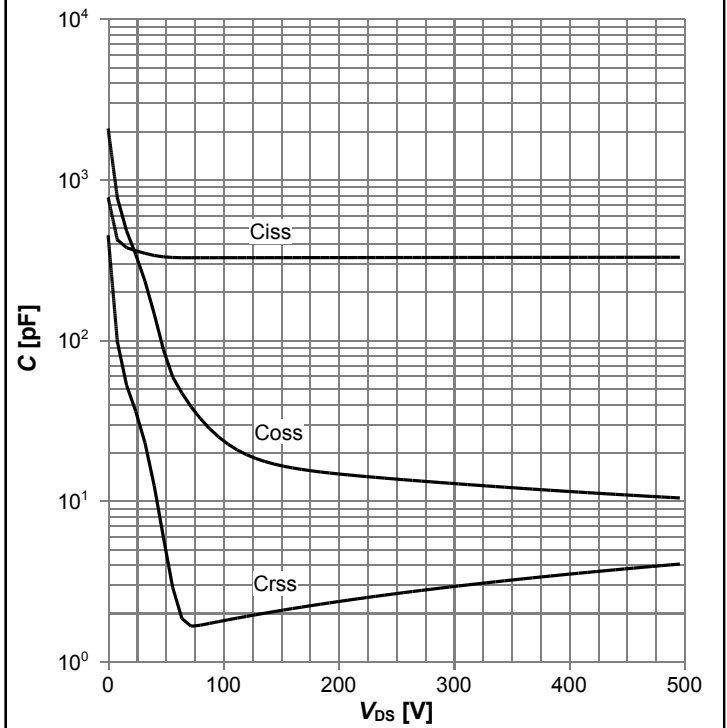

$C=f(V_{DS}); V_{GS}=0 \text{ V}; f=1 \text{ MHz}$

Diagram 15: Typ. Coss stored energy

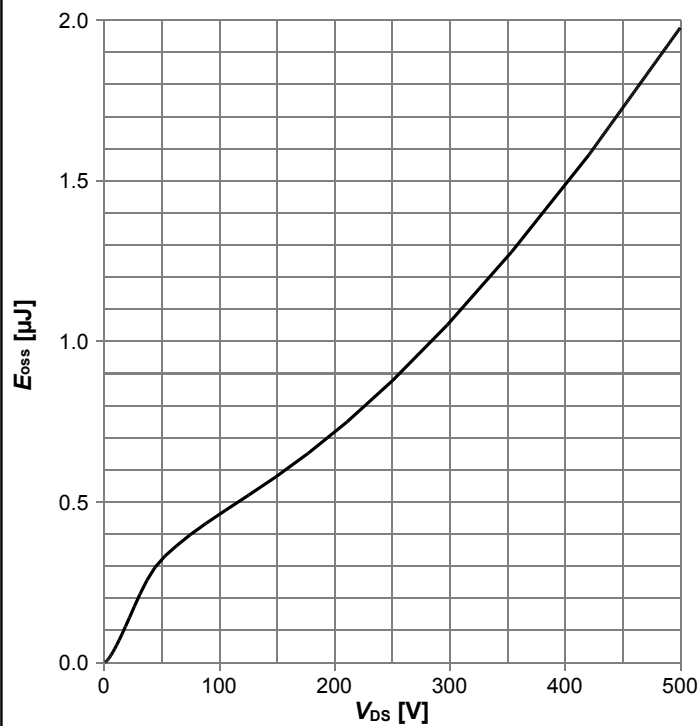

$E_{oss}=f(V_{DS})$

5 Test Circuits

Table 8 Diode characteristics

| Test circuit for diode characteristics | Diode recovery waveform |
|--|---|
| <p>$R_{g1} = R_{g2}$</p> | <p>$t_{tr} = t_F + t_S$ $Q_{tr} = Q_F + Q_S$</p> |

Table 9 Switching times

| Switching times test circuit for inductive load | Switching times waveform |
|---|--------------------------|
| | |

Table 10 Unclamped inductive load

| Unclamped inductive load test circuit | Unclamped inductive waveform |
|---------------------------------------|--------------------------------|
| | <p>$V_{(BR)DS}$</p> |

6 Package Outlines

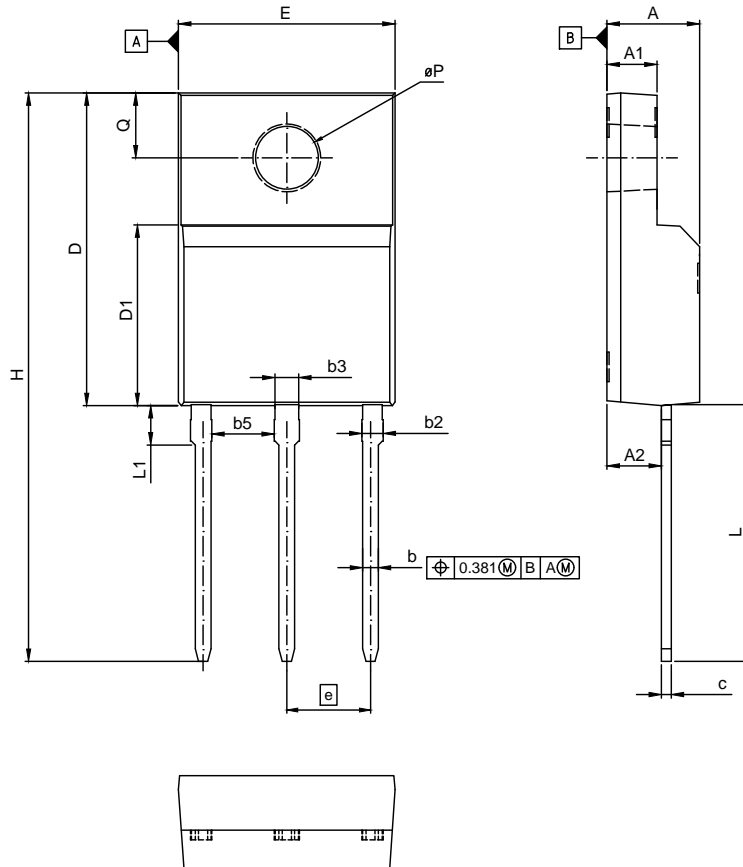

DIMENSIONS DO NOT INCLUDE MOLD FLASH, PROTRUSIONS OR GATE BURRS

| DIM | MILLIMETERS | | INCHES | |
|-----|-------------|-------|-------------|-------|
| | MIN | MAX | MIN | MAX |
| A | 4.50 | 4.90 | 0.177 | 0.193 |
| A1 | 2.34 | 2.74 | 0.092 | 0.108 |
| A2 | 2.65 | 2.95 | 0.104 | 0.116 |
| b | 0.75 | 0.90 | 0.030 | 0.035 |
| b2 | 0.98 | 1.26 | 0.039 | 0.050 |
| b3 | 1.00 | 1.40 | 0.039 | 0.055 |
| b5 | 3.00 | - | 0.118 | - |
| c | 0.40 | 0.60 | 0.016 | 0.024 |
| D | 15.47 | 16.27 | 0.609 | 0.641 |
| D1 | 9.17 | | 0.361 | |
| E | 10.70 | 11.30 | 0.421 | 0.445 |
| e | 4.25 (BSC) | | 0.167 (BSC) | |
| N | 3 | | 3 | |
| H | 28.25 | 29.45 | 1.112 | 1.159 |
| L | 12.58 | 13.38 | 0.495 | 0.527 |
| L1 | 1.70 | 2.30 | 0.067 | 0.091 |
| øP | 3.00 | 3.30 | 0.118 | 0.130 |
| Q | 3.10 | 3.50 | 0.122 | 0.138 |

| |
|-----------------------------|
| DOCUMENT NO. Z8B00176938 |
| SCALE 0 2 4 mm |
| EUROPEAN PROJECTION |
| ISSUE DATE 28-04-2015 |
| REVISION 01 |

Figure 1 Outline PG - TO220 FullPAK WideCreep, dimensions in mm/inches

7 Appendix A

Table 11 Related Links

- IFX CoolMOS™ CE Webpage: www.infineon.com
- IFX CoolMOS™ CE application note: www.infineon.com
- IFX CoolMOS™ CE simulation model: www.infineon.com
- IFX Design tools: www.infineon.com

700V CoolMOS™ CE Power Transistor

IPAW70R950CE

Revision History

IPAW70R950CE

Revision: 2016-09-27, Rev. 2.0

Previous Revision

| Revision | Date | Subjects (major changes since last revision) |
|----------|------------|--|
| 2.0 | 2016-09-27 | Release of final version |

Trademarks of Infineon Technologies AG

AURIX™, C166™, CanPAK™, CIPOS™, CoolGaN™, CoolMOS™, CoolSET™, CoolSiC™, CORECONTROL™, CROSSAVE™, DAVE™, DI-POL™, DrBlade™, EasyPIM™, EconoBRIDGE™, EconoDUAL™, EconoPACK™, EconoPIM™, EiceDRIVER™, eupec™, FCOS™, HITFET™, HybridPACK™, Infineon™, ISOFACE™, IsoPACK™, i-Wafer™, MIPAQ™, ModSTACK™, my-d™, NovalithIC™, OmniTune™, OPTIGA™, OptiMOS™, ORIGA™, POWERCODE™, PRIMARION™, PrimePACK™, PrimeSTACK™, PROFET™, PRO-SIL™, RASIC™, REAL3™, ReverSave™, SatRIC™, SIEGET™, SIPMOS™, SmartLEWIS™, SOLID FLASH™, SPOC™, TEMPFET™, thinQ!™, TRENCHSTOP™, TriCore™.

Trademarks updated August 2015

Other Trademarks

All referenced product or service names and trademarks are the property of their respective owners.

We Listen to Your Comments

Any information within this document that you feel is wrong, unclear or missing at all? Your feedback will help us to continuously improve the quality of this document. Please send your proposal (including a reference to this document) to:

erratum@infineon.com

Published by

Infineon Technologies AG

81726 München, Germany

© 2016 Infineon Technologies AG

All Rights Reserved.

Legal Disclaimer

The information given in this document shall in no event be regarded as a guarantee of conditions or characteristics ("Beschaffheitsgarantie").

With respect to any examples, hints or any typical values stated herein and/or any information regarding the application of the product, Infineon Technologies hereby disclaims any and all warranties and liabilities of any kind, including without limitation warranties of non-infringement of intellectual property rights of any third party.

In addition, any information given in this document is subject to customer's compliance with its obligations stated in this document and any applicable legal requirements, norms and standards concerning customer's products and any use of the product of Infineon Technologies in customer's applications.

The data contained in this document is exclusively intended for technically trained staff. It is the responsibility of customer's technical departments to evaluate the suitability of the product for the intended application and the completeness of the product information given in this document with respect to such application.

Information

For further information on technology, delivery terms and conditions and prices please contact your nearest Infineon Technologies Office (www.infineon.com).

Warnings

Due to technical requirements, components may contain dangerous substances. For information on the types in question, please contact the nearest Infineon Technologies Office.

The Infineon Technologies component described in this Data Sheet may be used in life-support devices or systems and/or automotive, aviation and aerospace applications or systems only with the express written approval of Infineon Technologies, if a failure of such components can reasonably be expected to cause the failure of that life-support, automotive, aviation and aerospace device or system or to affect the safety or effectiveness of that device or system. Life support devices or systems are intended to be implanted in the human body or to support and/or maintain and sustain and/or protect human life. If they fail, it is reasonable to assume that the health of the user or other persons may be endangered.