





OptiMOS® Power-Transistor

Features

- For fast switching converters and sync. rectification
- N-channel enhancement - logic level
- 175 °C operating temperature
- Avalanche rated
- Pb-free lead plating, RoHS compliant

Product Summary

V_{DS}	60	V
$R_{DS(on),max}$ SMDversion	4.4	mΩ
I_D	100	A

Type	IPP048N06L	IPB048N06L
		
Package	P-TO220-3-1	P-TO263-3-2
Marking	048N06L	048N06L

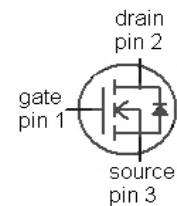

Maximum ratings, at $T_j=25\text{ °C}$, unless otherwise specified

Parameter	Symbol	Conditions	Value	Unit
Continuous drain current	I_D	$T_C=25\text{ °C}^1$	100	A
		$T_C=100\text{ °C}$	100	
Pulsed drain current	$I_{D,pulse}$	$T_C=25\text{ °C}^2$	400	
Avalanche energy, single pulse	E_{AS}	$I_D=100\text{ A}$, $R_{GS}=25\text{ Ω}$	810	mJ
Reverse diode dv/dt	dv/dt	$I_D=100\text{ A}$, $V_{DS}=48\text{ V}$, $di/dt=200\text{ A}/\mu\text{s}$, $T_{j,max}=175\text{ °C}$	6	kV/ μs
Gate source voltage	V_{GS}		± 20	V
Power dissipation	P_{tot}	$T_C=25\text{ °C}$	300	W
Operating and storage temperature	T_j , T_{stg}		-55 ... 175	°C
IEC climatic category; DIN IEC 68-1			55/175/56	

¹⁾ Current is limited by bondwire; with an $R_{thJC}=0.5$ the chip is able to carry 161A

²⁾ See figure 3



Parameter	Symbol	Conditions	Values			Unit
			min.	typ.	max.	

Thermal characteristics

Thermal resistance, junction - case	R_{thJC}		-	-	0.5	K/W
SMD version, device on PCB	R_{thJA}	minimal footprint	-	-	62	
		6 cm ² cooling area ³⁾	-	-	40	

Electrical characteristics, at $T_j=25\text{ }^\circ\text{C}$, unless otherwise specified**Static characteristics**

Drain-source breakdown voltage	$V_{(BR)DSS}$	$V_{GS}=0\text{ V}, I_D=1\text{ mA}$	60	-	-	V
Gate threshold voltage	$V_{GS(th)}$	$V_{DS}=V_{GS}, I_D=270\text{ }\mu\text{A}$	1.2	1.6	2	
Zero gate voltage drain current	I_{DSS}	$V_{DS}=60\text{ V}, V_{GS}=0\text{ V}, T_j=25\text{ }^\circ\text{C}$	-	0.01	1	μA
		$V_{DS}=60\text{ V}, V_{GS}=0\text{ V}, T_j=125\text{ }^\circ\text{C}$	-	1	100	
Gate-source leakage current	I_{GSS}	$V_{GS}=20\text{ V}, V_{DS}=0\text{ V}$	-	10	100	nA
Drain-source on-state resistance	$R_{DS(on)}$	$V_{GS}=10\text{ V}, I_D=100\text{ A}$	-	3.7	4.7	m Ω
		$V_{GS}=4.5\text{ V}, I_D=66\text{ A}$	-	4.4	5.7	
		$V_{GS}=10\text{ V}, I_D=100\text{ A},$ SMD version		3.4	4.4	
		$V_{GS}=4.5\text{ V}, I_D=66\text{ A},$ SMD version		4.1	5.4	
Gate resistance	R_G		-	1.9	-	Ω
Transconductance	g_{fs}	$ V_{DS} >2 I_D R_{DS(on)max},$ $I_D=100\text{ A}$	92	183	-	S

³⁾ Device on 40 mm x 40 mm x 1.5 mm epoxy PCB FR4 with 6 cm² (one layer, 70 μm thick) copper area for drain connection. PCB is vertical in still air.



Parameter	Symbol	Conditions	Values			Unit
			min.	typ.	max.	

Dynamic characteristics

Input capacitance	C_{iss}	$V_{GS}=0\text{ V}, V_{DS}=30\text{ V},$ $f=1\text{ MHz}$	-	5700	7600	pF
Output capacitance	C_{oss}		-	1500	2000	
Reverse transfer capacitance	C_{rss}		-	350	525	
Turn-on delay time	$t_{d(on)}$	$V_{DD}=30\text{ V}, V_{GS}=4.5\text{ V},$ $I_D=100\text{ A}, R_G=1.3\ \Omega$	-	18	27	ns
Rise time	t_r		-	25	38	
Turn-off delay time	$t_{d(off)}$		-	98	150	
Fall time	t_f		-	24	36	

Gate Charge Characteristics⁴⁾

Gate to source charge	Q_{gs}	$V_{DD}=30\text{ V}, I_D=100\text{ A},$ $V_{GS}=0\text{ to }10\text{ V}$	-	20	26	nC
Gate charge at threshold	$Q_{g(th)}$		-	9.1	12	
Gate to drain charge	Q_{gd}		-	54	81	
Switching charge	Q_{sw}		-	64	95	
Gate charge total	Q_g		-	169	225	
Gate plateau voltage	$V_{plateau}$		-	3.5	-	V
Output charge	Q_{oss}	$V_{DD}=30\text{ V}, V_{GS}=0\text{ V}$	-	47	63	

Reverse Diode

Diode continuous forward current	I_S	$T_C=25\text{ }^\circ\text{C}$	-	-	100	A
Diode pulse current	$I_{S,pulse}$		-	-	400	
Diode forward voltage	V_{SD}	$V_{GS}=0\text{ V}, I_F=100\text{ A},$ $T_j=25\text{ }^\circ\text{C}$	-	0.93	1.3	V
Reverse recovery time	t_{rr}	$V_R=30\text{ V}, I_F=I_S,$ $di_F/dt=100\text{ A}/\mu\text{s}$	-	65	80	ns
Reverse recovery charge	Q_{rr}		-	125	160	nC

⁴⁾ See figure 16 for gate charge parameter definition



1 Power dissipation

$P_{tot}=f(T_C); V_{GS} \geq 6 \text{ V}$

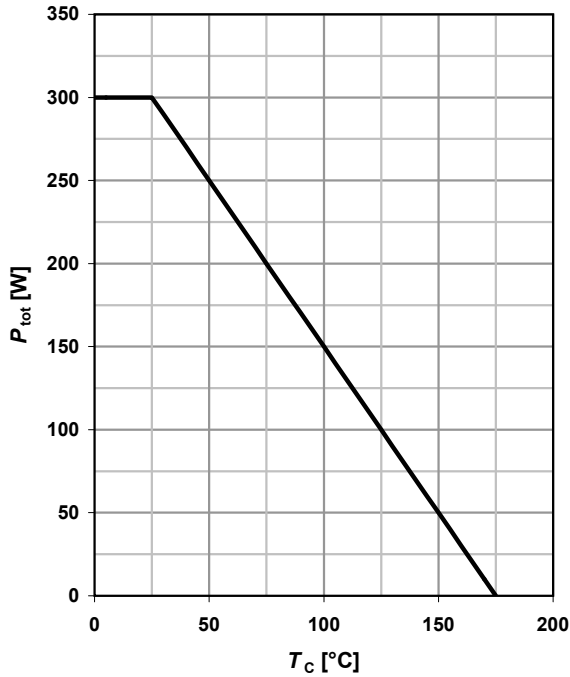

2 Drain current

$I_D=f(T_C); V_{GS} \geq 10 \text{ V}$

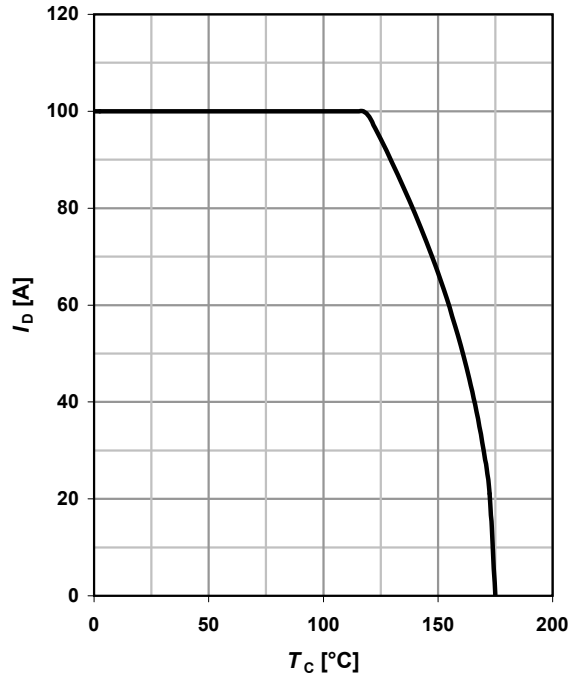

3 Safe operating area

$I_D=f(V_{DS}); T_C=25 \text{ °C}; D=0$

parameter: t_p

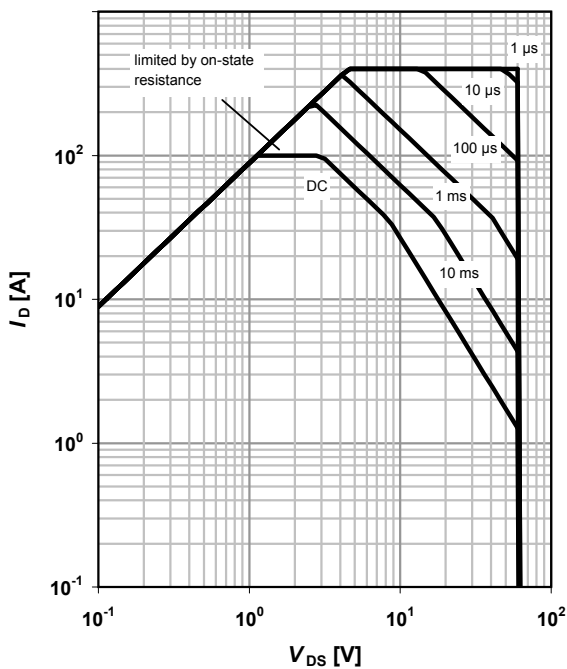

4 Max. transient thermal impedance

$Z_{thJC}=f(t_p)$

parameter: $D=t_p/T$

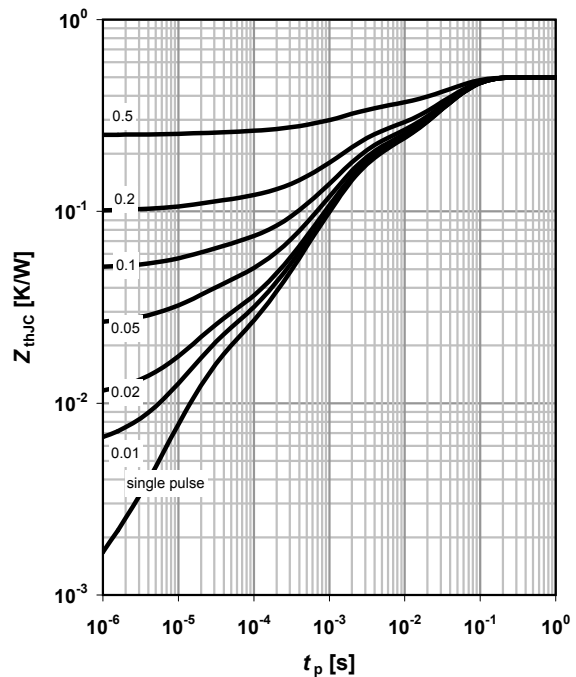



5 Typ. output characteristics

$I_D = f(V_{DS}); T_j = 25\text{ }^\circ\text{C}$

parameter: V_{GS}

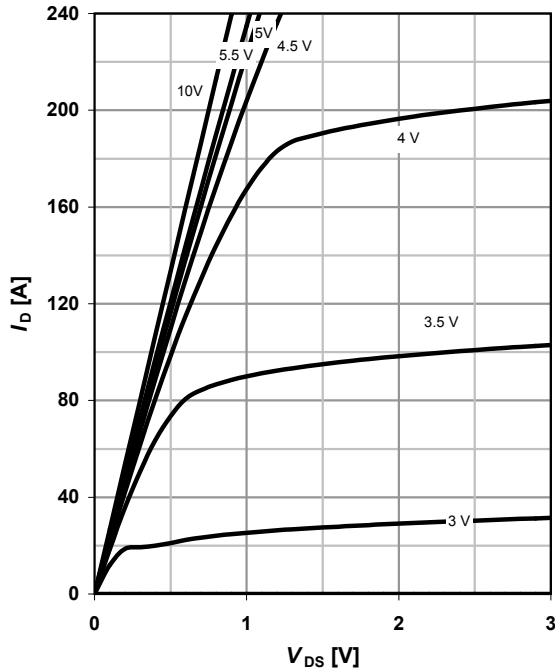

6 Typ. drain-source on resistance

$R_{DS(on)} = f(I_D); T_j = 25\text{ }^\circ\text{C}$

parameter: V_{GS}

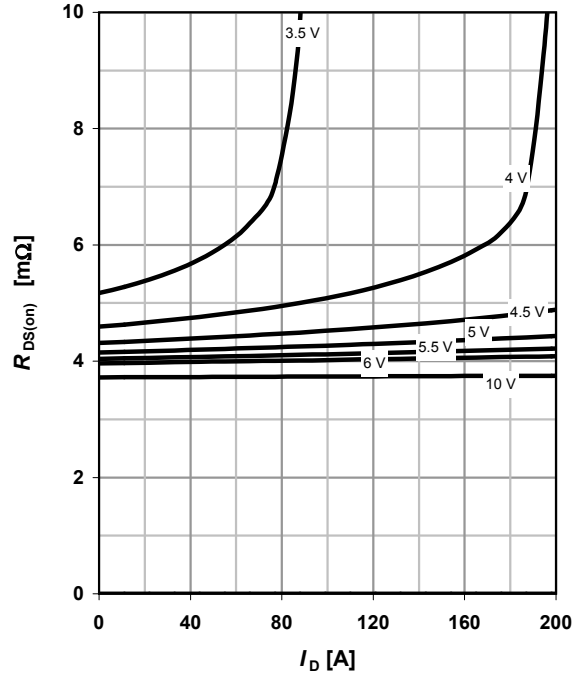

7 Typ. transfer characteristics

$I_D = f(V_{GS}); |V_{DS}| > 2|I_D|R_{DS(on)max}$

parameter: T_j

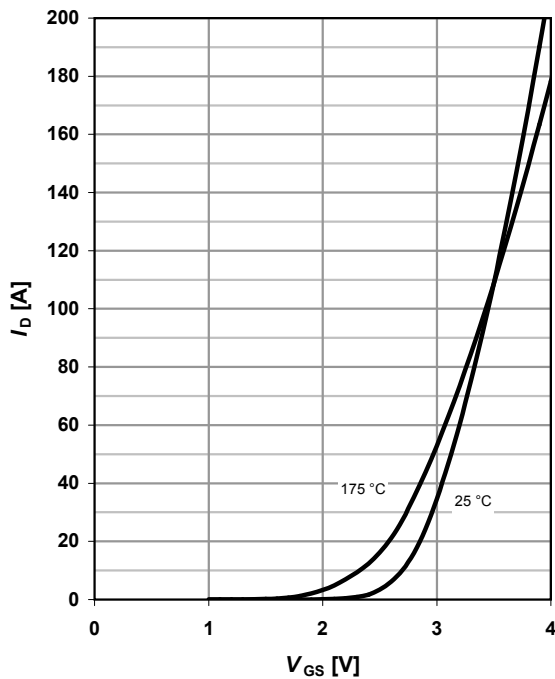

8 Typ. forward transconductance

$g_{fs} = f(I_D); T_j = 25\text{ }^\circ\text{C}$

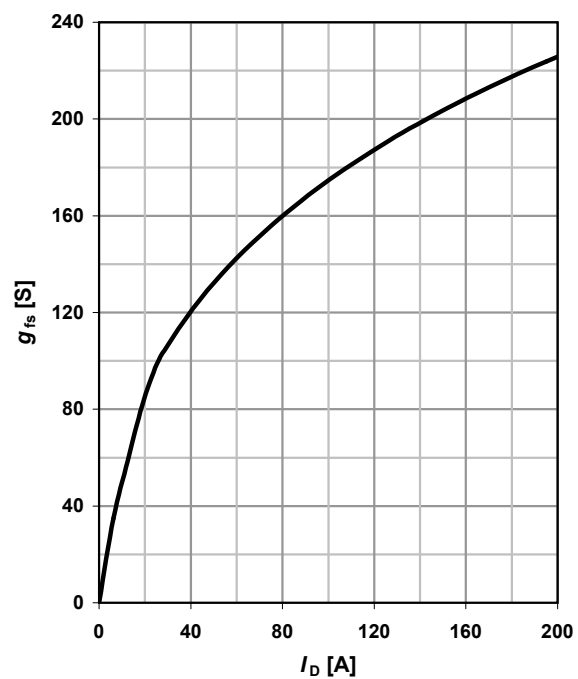



9 Drain-source on-state resistance

$R_{DS(on)} = f(T_j); I_D = 100 \text{ A}; V_{GS} = 10 \text{ V}$

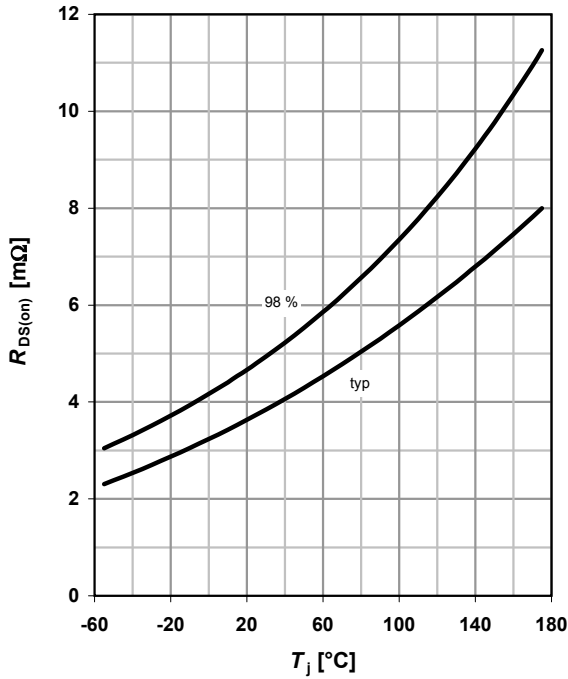

10 Typ. gate threshold voltage

$V_{GS(th)} = f(T_j); V_{GS} = V_{DS}$

parameter: I_D

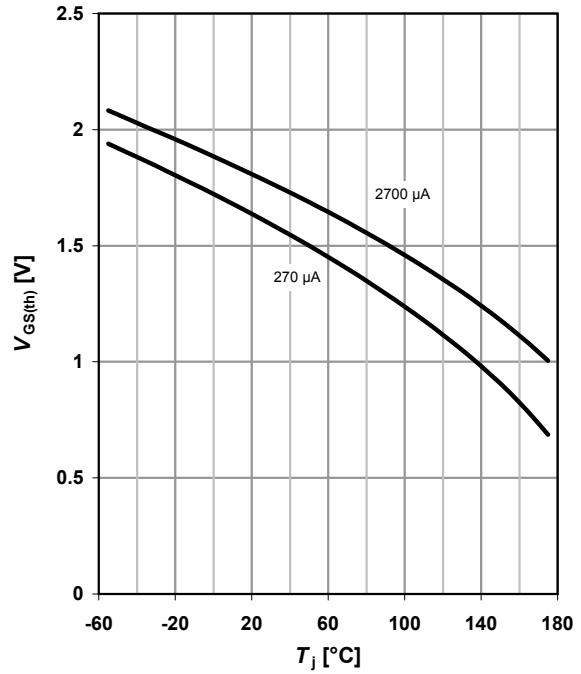

11 Typ. capacitances

$C = f(V_{DS}); V_{GS} = 0 \text{ V}; f = 1 \text{ MHz}$

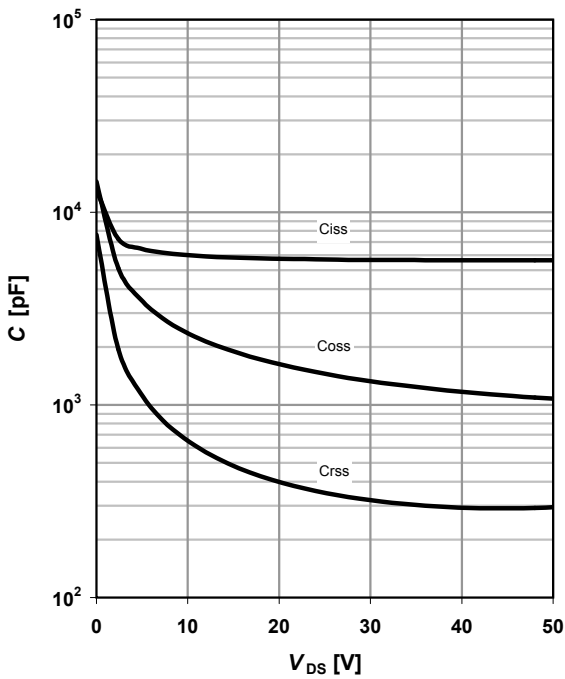

12 Forward characteristics of reverse diode

$I_F = f(V_{SD})$

parameter: T_j

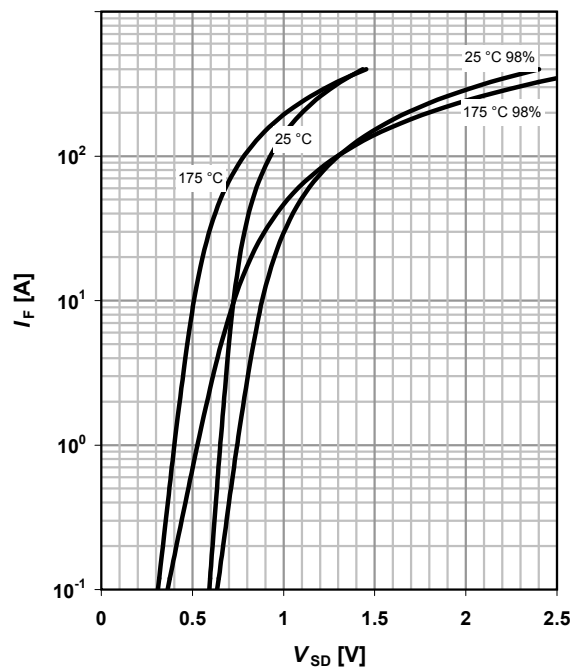



13 Avalanche characteristics

$I_{AS}=f(t_{AV}); R_{GS}=25 \Omega$

parameter: $T_{j(start)}$

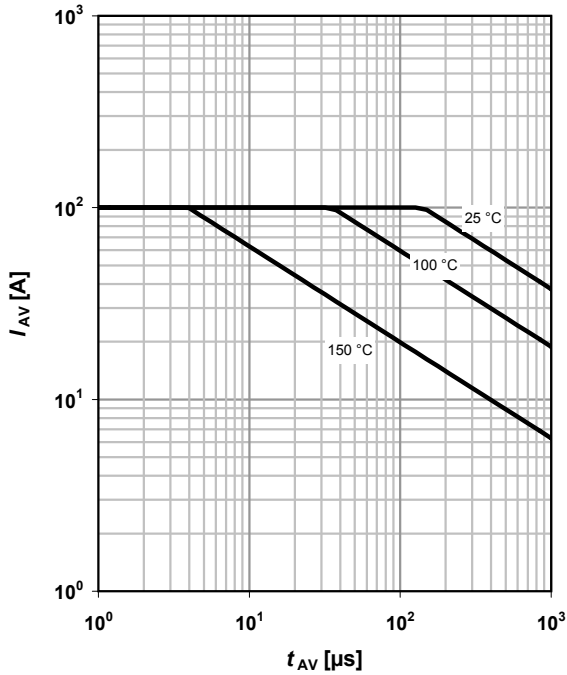

14 Typ. gate charge

$V_{GS}=f(Q_{gate}); I_D=100 \text{ A pulsed}$

parameter: V_{DD}

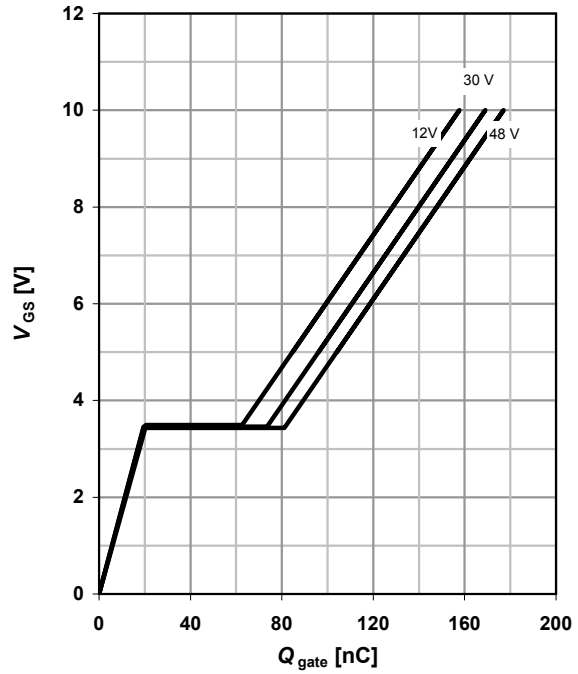

15 Drain-source breakdown voltage

$V_{BR(DSS)}=f(T_j); I_D=1 \text{ mA}$

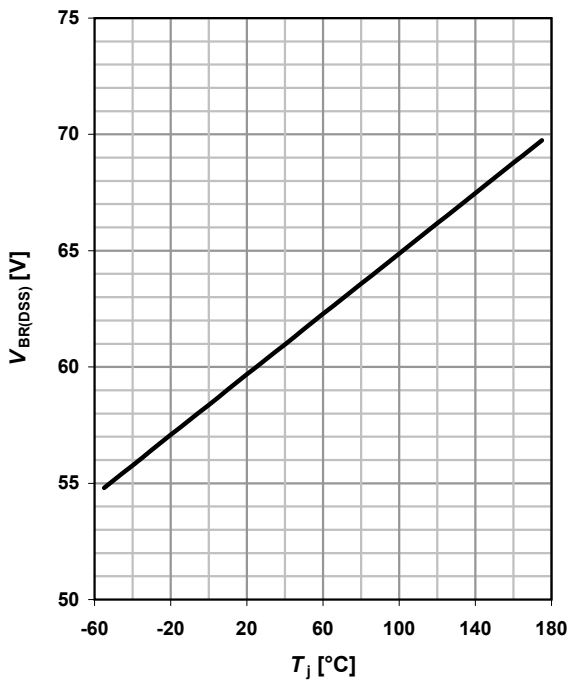

16 Gate charge waveforms

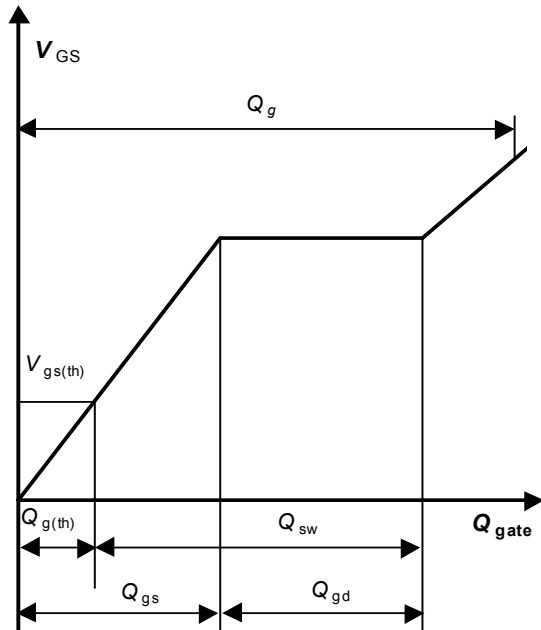



PG-TO-263 (D²-Pak)

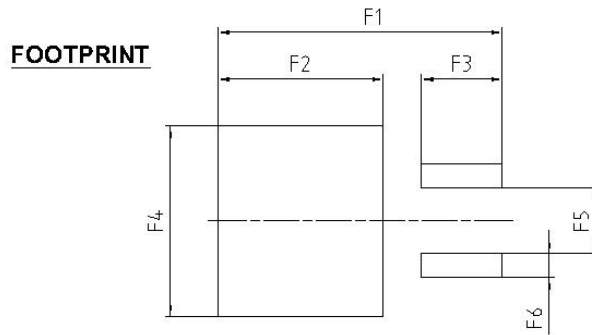
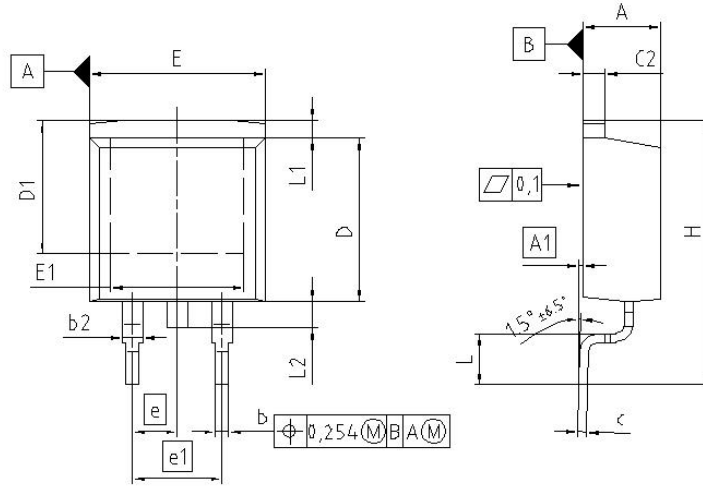

DIM	MILLIMETERS		INCHES	
	MIN	MAX	MIN	MAX
A	4.300	4.572	0.169	0.180
A1	0.000	0.254	0.000	0.010
b	0.650	0.850	0.026	0.033
b2	0.950	1.321	0.037	0.052
c	0.330	0.650	0.013	0.026
c2	0.170	1.400	0.046	0.055
D	8.509	9.450	0.335	0.372
D1	7.100	-	0.280	-
E	9.800	10.312	0.386	0.406
E1	6.500	-	0.256	-
e	2.540		0.100	
e1	5.080		0.200	
N	2		2	
H	14.605	15.875	0.575	0.625
L	2.200	3.000	0.087	0.118
L1	-	1.600	-	0.063
L2	1.000	1.778	0.039	0.070
F1	16.050	16.250	0.632	0.640
F2	9.300	9.500	0.366	0.374
F3	4.500	4.700	0.177	0.185
F4	10.700	10.900	0.421	0.429
F5	3.630	3.830	0.143	0.151
F6	1.100	1.300	0.043	0.051

REFERENCE
JEDEC TO263

SCALE

EUROPEAN PROJECTION

ISSUE DATE
12-02-2006

FILE
TO263_2



PG-TO220-3: Outline

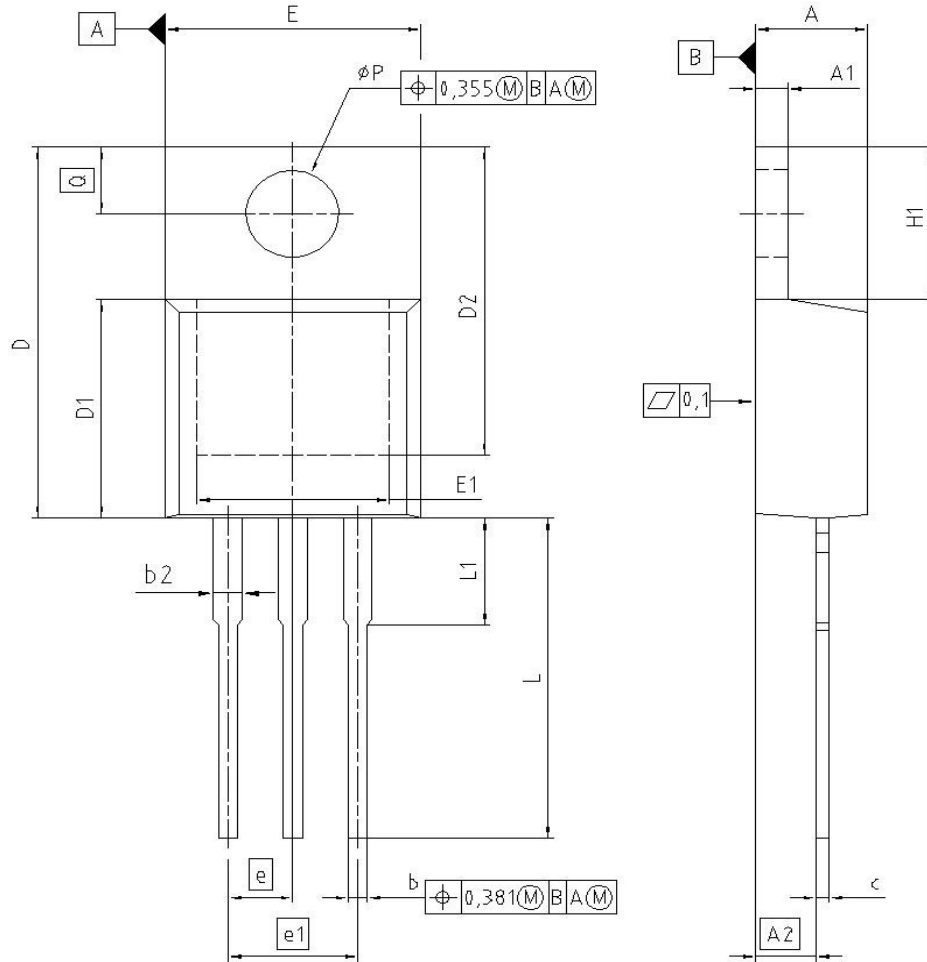

DIM	MILLIMETERS		INCHES	
	MIN	MAX	MIN	MAX
A	4.300	4.572	0.169	0.180
A1	1.170	1.400	0.046	0.055
A2	2.215	2.718	0.087	0.107
b	0.650	0.864	0.026	0.034
b2	0.635	1.778	0.025	0.070
c	0.330	0.600	0.013	0.024
D	14.808	15.950	0.583	0.628
D1	8.509	9.450	0.335	0.372
D2	12.850	13.100	0.506	0.516
E	9.700	10.363	0.382	0.408
E1	6.500	8.600	0.256	0.339
e	2.540		0.100	
e1	5.080		0.200	
N	3		3	
H1	5.900	6.900	0.232	0.272
L	13.000	14.000	0.512	0.551
L1	-	4.800	-	0.189
pP	3.700	3.886	0.146	0.153
Q	2.600	3.000	0.102	0.118

REFERENCE
JEDEC TO220

SCALE

EUROPEAN PROJECTION

ISSUE DATE
01-06-2005

FILE
TO220_1



Published by
Infineon Technologies AG
81726 München, Germany
© Infineon Technologies AG 2006.
All Rights Reserved.

Attention please!

The information given in this data sheet shall in no event be regarded as a guarantee of conditions or characteristics ("Beschaffenheitsgarantie"). With respect to any examples or hints given herein, any typical values stated herein and/or any information regarding the application of the device, Infineon Technologies hereby non-infringement of intellectual property rights of any third party

Information

For further information on technology, delivery terms and conditions and prices please contact your nearest Infineon Technologies Office (www.infineon.com).

Warnings

Due to technical requirements components may contain dangerous substances. For information on the types in question please contact your nearest Infineon Technologies Office.
Infineon Technologies Components may only be used in life-support devices or systems with the express written approval of Infineon Technologies, if a failure of such components can reasonably be expected to cause the failure of that life-support device or system, or to affect the safety or effectiveness of that device or system. Life support devices or systems are intended to be implanted in the human body, or to support and/or maintain and sustain and/or protect human life. If they fail, it is reasonable to assume that the health of the user or other persons may be endangered.