

CoolMOS™ Power Transistor
Features

- Lowest figure-of-merit $R_{ON} \times Q_g$
- Ultra low gate charge
- Extreme dv/dt rated
- High peak current capability
- Qualified according to JEDEC⁽¹⁾ for target applications
- Pb-free lead plating; RoHS compliant

CoolMOS CP is designed for:

- Hard switching SMPS topologies

Product Summary

$V_{DS} @ T_{j,max}$	650	V
$R_{DS(on),max} @ T_j = 25^\circ C$	0.520	Ω
$Q_{g,typ}$	24	nC

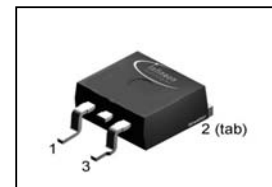
PG-TO263

Type	Package	Marking
IPB60R520CP	PG-TO263	6R520P

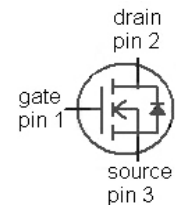
Maximum ratings, at $T_j=25^\circ C$, unless otherwise specified

Parameter	Symbol	Conditions	Value	Unit
Continuous drain current	I_D	$T_C=25^\circ C$	6.8	A
		$T_C=100^\circ C$	4.3	
Pulsed drain current ⁽²⁾	$I_{D,pulse}$	$T_C=25^\circ C$	17	
Avalanche energy, single pulse	E_{AS}	$I_D=2.5 A, V_{DD}=50 V$	166	mJ
Avalanche energy, repetitive t_{AR} ^(2),3)	E_{AR}	$I_D=2.5 A, V_{DD}=50 V$	0.25	
Avalanche current, repetitive t_{AR} ^(2),3)	I_{AR}		2.5	A
MOSFET dv/dt ruggedness	dv/dt	$V_{DS}=0...480 V$	50	V/ns
Gate source voltage	V_{GS}	static	± 20	V
		AC ($f > 1$ Hz)	± 30	
Power dissipation	P_{tot}	$T_C=25^\circ C$	66	W
Operating and storage temperature	T_j, T_{stg}		-55 ... 150	$^\circ C$

Maximum ratings, at $T_j=25\text{ °C}$, unless otherwise specified

Parameter	Symbol	Conditions	Value	Unit
Continuous diode forward current	I_S	$T_C=25\text{ °C}$	3.8	A
Diode pulse current ²⁾	$I_{S,pulse}$		17	
Reverse diode dv/dt ⁴⁾	dv/dt		15	V/ns

Parameter	Symbol	Conditions	Values			Unit
			min.	typ.	max.	

Thermal characteristics

Thermal resistance, junction - case	R_{thJC}		-	-	1.9	K/W
Thermal resistance, junction - ambient	R_{thJA}	leaded	-	-	62	
	R_{thJA}	SMD version, device on PCB, minimal footprint	-	-	62	
		SMD version, device on PCB, 6 cm ² cooling area ³⁾	-	35	-	

Electrical characteristics, at $T_j=25\text{ °C}$, unless otherwise specified
Static characteristics

Drain-source breakdown voltage	$V_{(BR)DSS}$	$V_{GS}=0\text{ V}$, $I_D=250\text{ }\mu\text{A}$	600	-	-	V
Gate threshold voltage	$V_{GS(th)}$	$V_{DS}=V_{GS}$, $I_D=250\text{ }\mu\text{A}$	2.5	3	3.5	
Zero gate voltage drain current	I_{DSS}	$V_{DS}=600\text{ V}$, $V_{GS}=0\text{ V}$, $T_j=25\text{ °C}$	-	-	1	μA
		$V_{DS}=600\text{ V}$, $V_{GS}=0\text{ V}$, $T_j=150\text{ °C}$	-	10	-	
Gate-source leakage current	I_{GSS}	$V_{GS}=20\text{ V}$, $V_{DS}=0\text{ V}$	-	-	100	nA
Drain-source on-state resistance	$R_{DS(on)}$	$V_{GS}=10\text{ V}$, $I_D=3.8\text{ A}$, $T_j=25\text{ °C}$	-	0.47	0.52	Ω
		$V_{GS}=10\text{ V}$, $I_D=3.8\text{ A}$, $T_j=150\text{ °C}$	-	1.3	-	
Gate resistance	R_G	$f=1\text{ MHz}$, open drain	-	1.3	-	Ω

Parameter	Symbol	Conditions	Values			Unit
			min.	typ.	max.	

Dynamic characteristics

Input capacitance	C_{iss}	$V_{GS}=0\text{ V}, V_{DS}=100\text{ V},$ $f=1\text{ MHz}$	-	630	-	pF
Output capacitance	C_{oss}		-	32	-	
Effective output capacitance, energy related ⁵⁾	$C_{o(er)}$	$V_{GS}=0\text{ V}, V_{DS}=0\text{ V}$ to 480 V	-	30	-	
Effective output capacitance, time related ⁶⁾	$C_{o(tr)}$		-	77	-	
Turn-on delay time	$t_{d(on)}$	$V_{DD}=400\text{ V},$ $V_{GS}=10\text{ V}, I_D=3.8\text{ A},$ $R_G=14.7\Omega$	-	17	-	ns
Rise time	t_r		-	12	-	
Turn-off delay time	$t_{d(off)}$		-	74	-	
Fall time	t_f		-	16	-	

Gate Charge Characteristics

Gate to source charge	Q_{gs}	$V_{DD}=480\text{ V}, I_D=3.8\text{ A},$ $V_{GS}=0\text{ to }10\text{ V}$	-	3	-	nC
Gate to drain charge	Q_{gd}		-	11	-	
Gate charge total	Q_g		-	24	31	
Gate plateau voltage	$V_{plateau}$		-	4.7	-	V

Reverse Diode

Diode forward voltage	V_{SD}	$V_{GS}=0\text{ V}, I_F=3.8\text{ A},$ $T_j=25\text{ }^\circ\text{C}$	-	0.8	1.2	V
Reverse recovery time	t_{rr}	$V_R=400\text{ V}, I_F=I_S,$ $di_F/dt=100\text{ A}/\mu\text{s}$	-	230	-	ns
Reverse recovery charge	Q_{rr}		-	2.5	-	μC
Peak reverse recovery current	I_{rrm}		-	20	-	A

¹⁾ J-STD20 and JESD22

²⁾ Pulse width t_p limited by $T_{j,max}$

³⁾ Repetitive avalanche causes additional power losses that can be calculated as $P_{AV}=E_{AR} \cdot f$.

⁴⁾ $I_{SD}=I_D, di/dt \leq 400\text{ A}/\mu\text{s}, V_{DClink}=400\text{ V}, V_{peak} < V_{(BR)DSS}, T_j < T_{j,max}$, identical low side and high side switch

⁵⁾ $C_{o(er)}$ is a fixed capacitance that gives the same stored energy as C_{oss} while V_{DS} is rising from 0 to 80% V_{DSS} .

⁶⁾ $C_{o(tr)}$ is a fixed capacitance that gives the same charging time as C_{oss} while V_{DS} is rising from 0 to 80% V_{DSS} .

1 Power dissipation

$$P_{tot} = f(T_C)$$

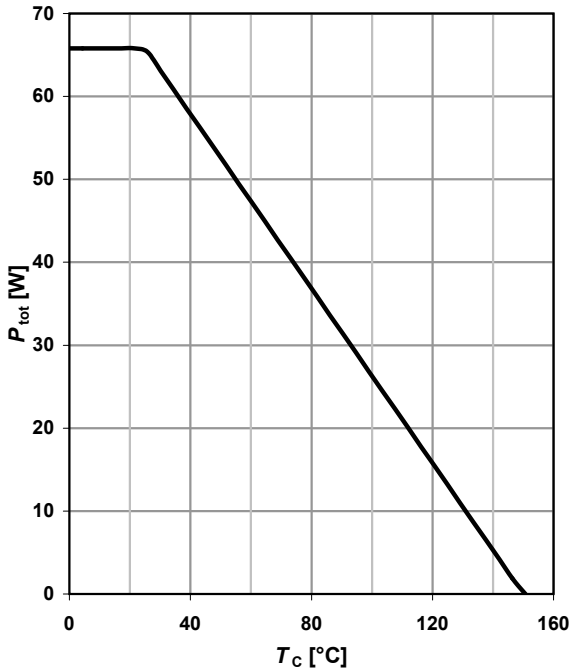

2 Safe operating area

$$I_D = f(V_{DS}); T_C = 25^\circ\text{C}; D = 0$$

parameter: t_p

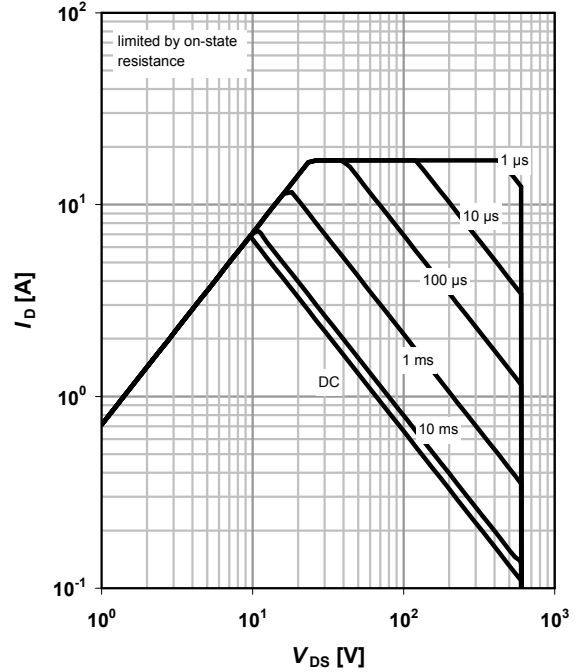

3 Max. transient thermal impedance

$$Z_{thJC} = f(t_p)$$

parameter: $D = t_p / T$

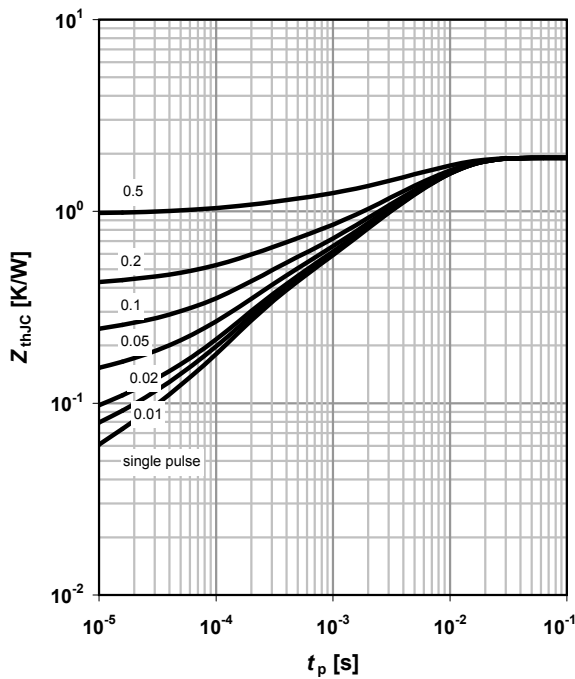

4 Typ. output characteristics

$$I_D = f(V_{DS}); T_j = 25^\circ\text{C}$$

parameter: V_{GS}

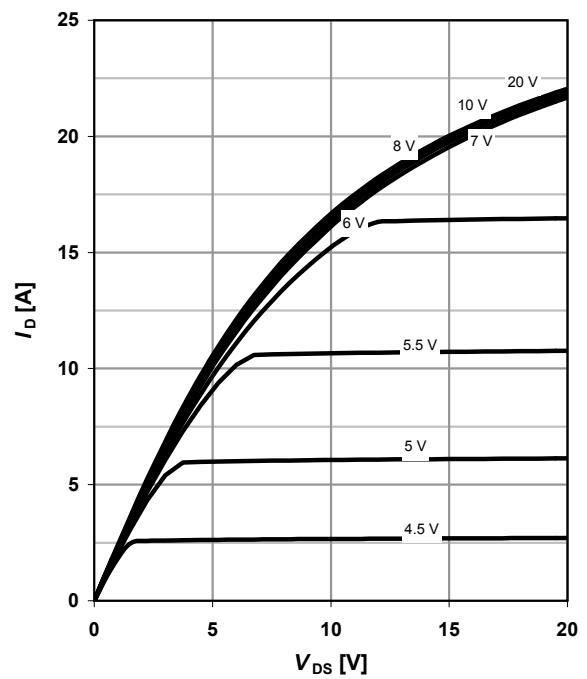

5 Typ. output characteristics

$I_D = f(V_{DS}); T_j = 150\text{ }^\circ\text{C}$

parameter: V_{GS}

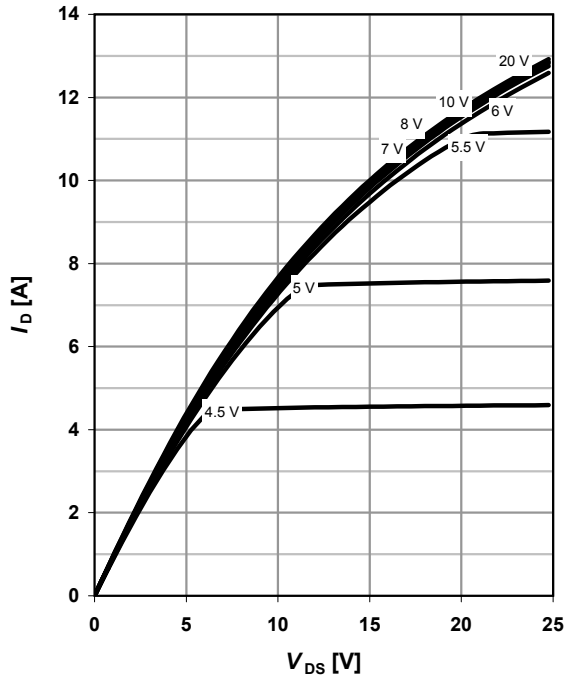

6 Typ. drain-source on-state resistance

$R_{DS(on)} = f(I_D); T_j = 150\text{ }^\circ\text{C}$

parameter: V_{GS}

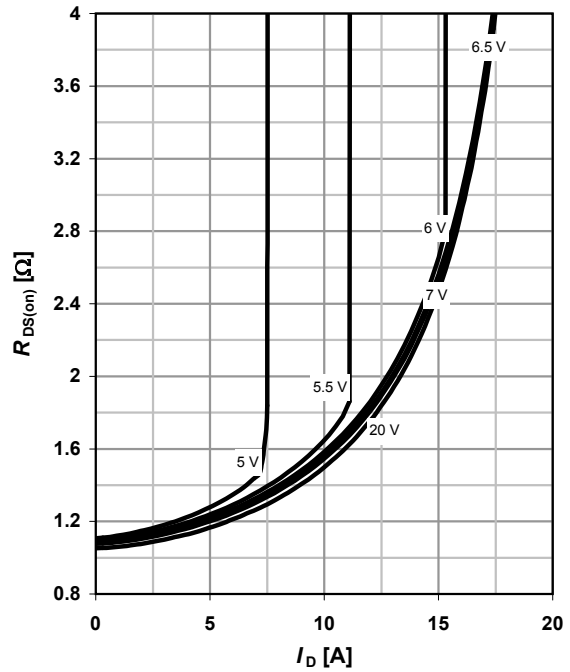

7 Drain-source on-state resistance

$R_{DS(on)} = f(T_j); I_D = 3.8\text{ A}; V_{GS} = 10\text{ V}$

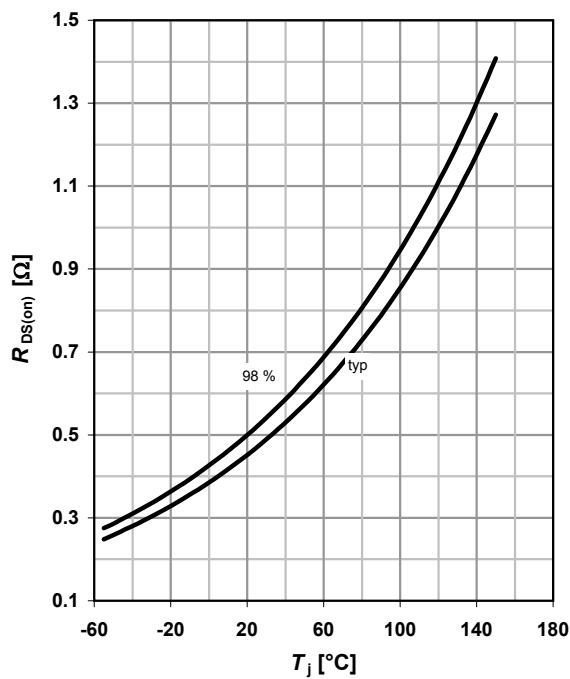

8 Typ. transfer characteristics

$I_D = f(V_{GS}); |V_{DS}| > 2|I_D|R_{DS(on)max}$

parameter: T_j

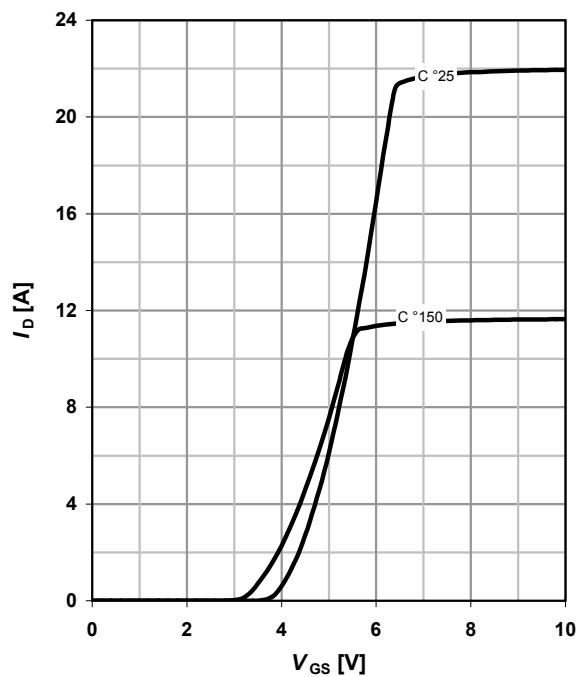

9 Typ. gate charge

$V_{GS}=f(Q_{gate}); I_D=3.8 \text{ A pulsed}$

parameter: V_{DD}

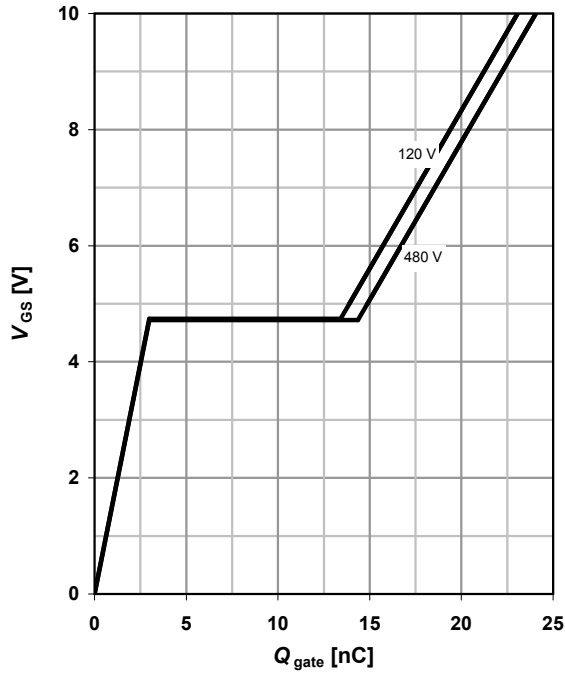

10 Forward characteristics of reverse diode

$I_F=f(V_{SD})$

parameter: T_j

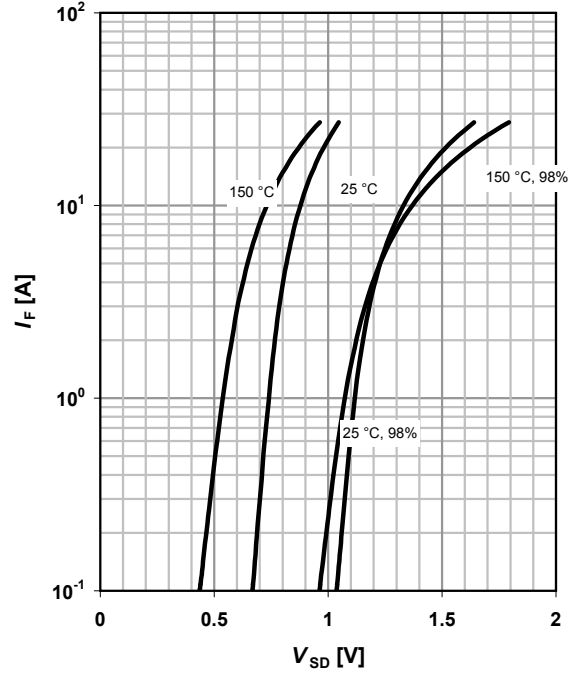

11 Avalanche energy

$E_{AS}=f(T_j); I_D=2.5 \text{ A}; V_{DD}=50 \text{ V}$

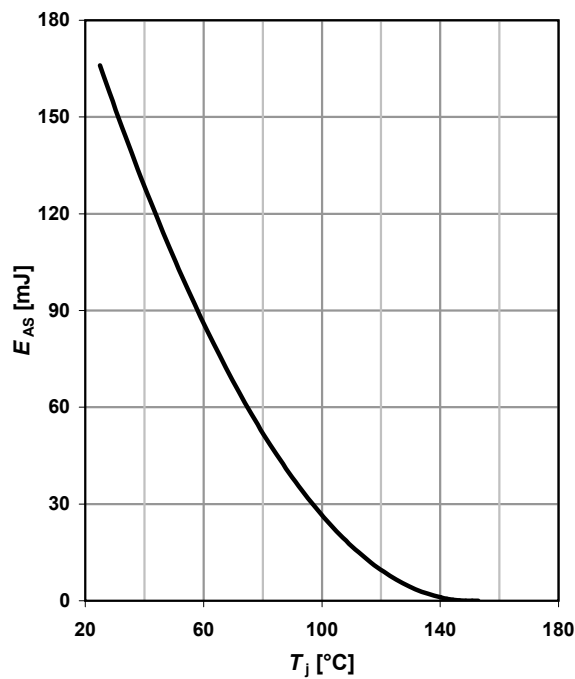

12 Drain-source breakdown voltage

$V_{BR(DSS)}=f(T_j); I_D=0.25 \text{ mA}$



13 Typ. capacitances

$C = f(V_{DS}); V_{GS} = 0 \text{ V}; f = 1 \text{ MHz}$

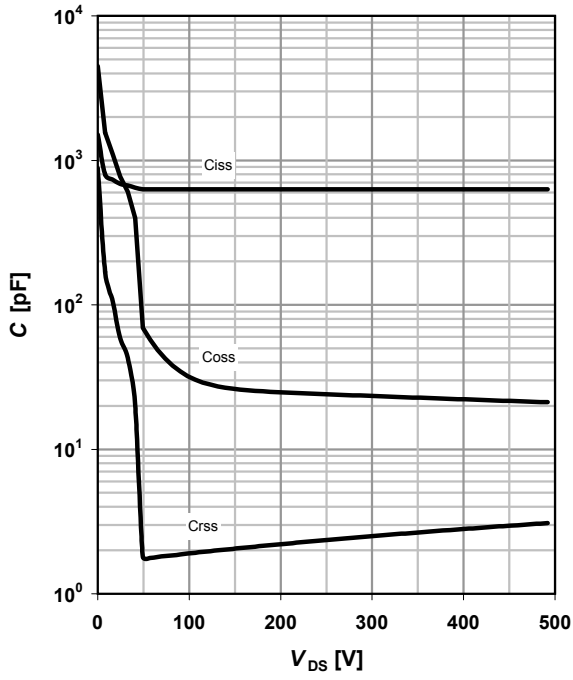

14 Typ. Coss stored energy

$E_{oss} = f(V_{DS})$

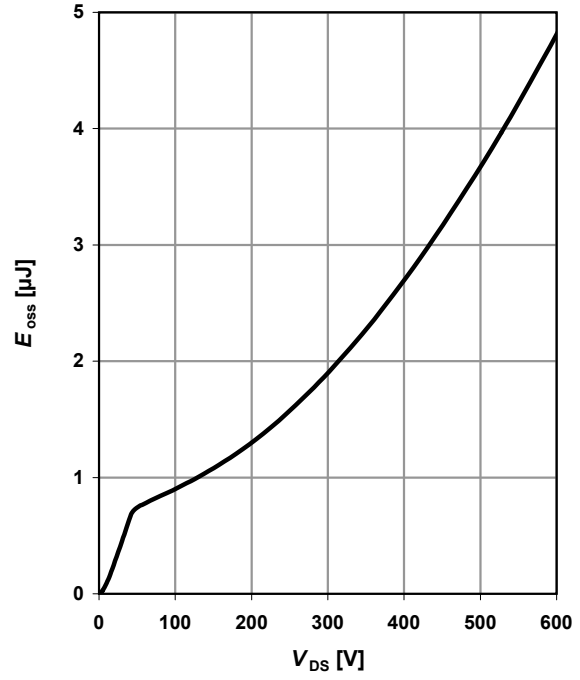

Definition of diode switching characteristics



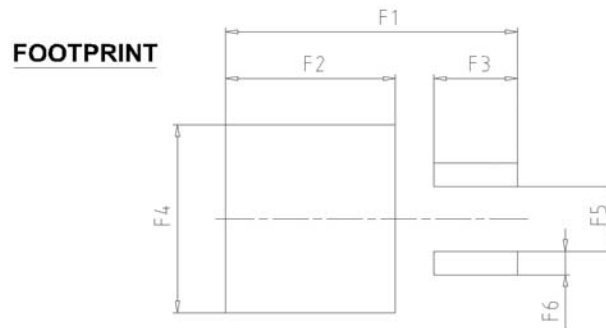
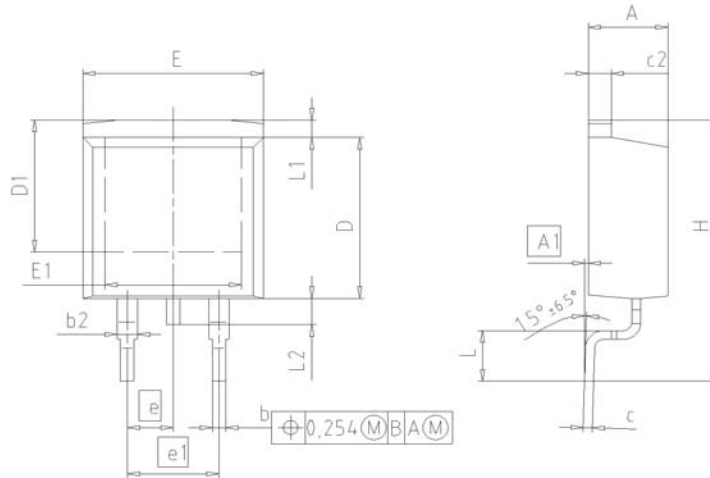

DIM	MILLIMETERS		INCHES	
	MIN	MAX	MIN	MAX
A	4.30	4.57	0.169	0.180
A1	0.00	0.25	0.000	0.010
b	0.65	0.85	0.026	0.033
b2	0.95	1.15	0.037	0.045
c	0.33	0.65	0.013	0.026
c2	1.17	1.40	0.046	0.055
D	8.51	9.45	0.335	0.372
D1	7.10	7.90	0.280	0.311
E	9.80	10.31	0.386	0.406
E1	6.50	8.60	0.256	0.339
e	2.54		0.100	
e1	5.08		0.200	
N	2		2	
H	14.61	15.88	0.575	0.625
L	2.29	3.00	0.090	0.118
L1	0.70	1.60	0.028	0.063
L2	1.00	1.78	0.039	0.070
F1	16.05	16.25	0.632	0.640
F2	9.30	9.50	0.366	0.374
F3	4.50	4.70	0.177	0.185
F4	10.70	10.90	0.421	0.429
F5	3.65	3.85	0.144	0.152
F6	1.25	1.45	0.049	0.057

DOCUMENT NO.
Z8B00003324

SCALE

EUROPEAN PROJECTION

ISSUE DATE
30-08-2007

REVISION
01

Published by
Infineon Technologies AG
81726 Munich, Germany
© 2008 Infineon Technologies AG
All Rights Reserved.

Legal Disclaimer

The information given in this document shall in no event be regarded as a guarantee of conditions or characteristics. With respect to any examples or hints given herein, any typical values stated herein and/or any information regarding the application of the device, Infineon Technologies hereby disclaims any and all warranties and liabilities of any kind, including without limitation, warranties of non-infringement of intellectual property rights of any third party.

Information

For further information on technology, delivery terms and conditions and prices, please contact the nearest Infineon Technologies Office
www.infineon.com

Warnings

Due to technical requirements, components may contain dangerous substances. For information on the types in question, please contact the nearest Infineon Technologies Office.
Infineon Technologies components may be used in life-support devices or systems only with the express written approval of Infineon Technologies, if a failure of such components can reasonably be expected to cause the failure of that life-support device or system or to affect the safety or effectiveness of that device or system. Life support devices or systems are intended to be implanted in the human body or to support and/or maintain and sustain and/or protect human life. If they fail, it is reasonable to assume that the health of the user or other persons may be endangered.