

# MOSFET

Metal Oxide Semiconductor Field Effect Transistor

## CFDA Automotive

650V CoolMOS™ CFDA Power Transistor  
IPD65R420CFDA

## Data Sheet

Rev. 2.1  
Final

Automotive

## 1 Description

CoolMOS™ is a revolutionary technology for high voltage power MOSFETs, designed according to the superjunction (SJ) principle and pioneered by Infineon Technologies. 650V CoolMOS™ CFDA series combines the experience of the leading SJ MOSFET supplier with high class innovation. The resulting devices provide all benefits of a fast switching SJ MOSFET while offering an extremely fast and robust body diode. This combination of extremely low switching, commutation and conduction losses together with highest robustness make especially resonant switching applications more reliable, more efficient, lighter, and cooler.

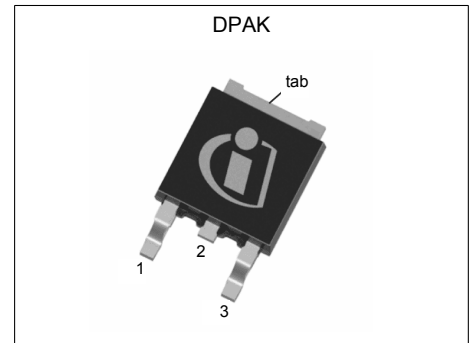

## Features

- Ultra-fast body diode
- Very high commutation ruggedness
- Extremely low losses due to very low FOM  $R_{ds(on)} \cdot Q_g$  and  $E_{oss}$
- Easy to use/drive
- Qualified according to AEC Q101
- Green package (RoHS compliant), Pb-free plating, halogen free for mold compound

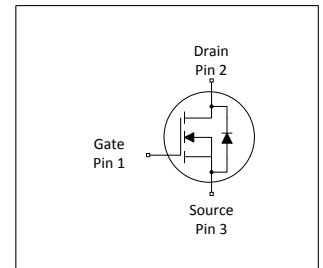

## Applications

650V CoolMOS™ CFDA is designed for switching applications.



**Table 1 Key Performance Parameters**

Parameter	Value	Unit
$V_{DS}$	650	V
$R_{DS(on),max}$	0.42	$\Omega$
$Q_g,typ$	90	nC
$I_D,pulse$	80	A
$E_{oss @ 400V}$	2.8	$\mu J$
Body diode $di/dt$	500	A/ $\mu s$
$Q_{rr}$	0.7	$\mu C$
$t_{rr}$	140	ns
$I_{rrm}$	8.8	A



Type / Ordering Code	Package	Marking	Related Links
IPD65R420CFDA	PG-TO 252	65F420A	-

**Table of Contents**

Description .....	2
Table of Contents .....	3
Maximum ratings .....	4
Thermal characteristics .....	5
Electrical characteristics .....	6
Electrical characteristics diagrams .....	8
Test Circuits .....	12
Package Outlines .....	13
Revision History .....	14
Disclaimer .....	14

## 2 Maximum ratings

at  $T_j = 25^\circ\text{C}$ , unless otherwise specified

**Table 2 Maximum ratings**

Parameter	Symbol	Values			Unit	Note / Test Condition
		Min.	Typ.	Max.		
Continuous drain current <sup>1)</sup>	$I_D$			8.7	A	$T_C = 25^\circ\text{C}$
				5.5		$T_C = 100^\circ\text{C}$
Pulsed drain current <sup>2)</sup>	$I_{D,pulse}$			27	A	$T_C = 25^\circ\text{C}$
Avalanche energy, single pulse	$E_{AS}$			227	mJ	$I_D = 1.8\text{A}$ , $V_{DD} = 50\text{V}$
Avalanche energy, repetitive	$E_{AR}$			0.34	mJ	$I_D = 1.8\text{A}$ , $V_{DD} = 50\text{V}$
Avalanche current, repetitive	$I_{AR}$			1.8	A	
MOSFET dv/dt ruggedness	dv/dt			50	V/ns	$V_{DS} = 0 \dots 400\text{V}$
Gate source voltage	$V_{GS}$	-20		20	V	static
		-30		30		AC ( $f > 1\text{ Hz}$ )
Power dissipation (SMD) DPAK	$P_{tot}$			83.3	W	$T_C = 25^\circ\text{C}$
Operating and storage temperature	$T_j, T_{stg}$	-40		150	$^\circ\text{C}$	
Continuous diode forward current	$I_S$			8.7	A	$T_C = 25^\circ\text{C}$
Diode pulse current	$I_{S,pulse}$			27	A	$T_C = 25^\circ\text{C}$
Reverse diode dv/dt <sup>3)</sup>	dv/dt			50	V/ns	$V_{DS} = 0 \dots 400\text{V}$ , $I_{SD} \leq I_D$ , $T_j = 25^\circ\text{C}$
Maximum diode commutation speed	di/dt			900	A/ $\mu\text{s}$	

<sup>1)</sup> Limited by  $T_{j,max}$

<sup>2)</sup> Pulse width  $t_p$  limited by  $T_{j,max}$

<sup>3)</sup> Identical low side and high side switch with identical  $R_\theta$

### 3 Thermal characteristics

**Table 3 Thermal characteristics DPAK**

Parameter	Symbol	Values			Unit	Note / Test Condition
		Min.	Typ.	Max.		
Thermal resistance, junction - case	$R_{thJC}$			1.5	K/W	
Thermal resistance, junction - ambient <sup>1)</sup>	$R_{thJA}$			62	K/W	SMD version, device on PCB, minimal footprint
			35			SMD version, device on PCB, 6cm <sup>2</sup> cooling area
Soldering temperature, wave- & reflowsoldering allowed	$T_{sold}$			260	°C	reflow MSL

<sup>1)</sup> Device on 40mm\*40mm\*1.5mm one layer epoxy PCB FR4 with 6cm<sup>2</sup> copper area (thickness 70µm) for drain connection. PCB is vertical without air stream cooling.

## 4 Electrical characteristics

at  $T_j = 25^\circ\text{C}$ , unless otherwise specified

**Table 4 Static characteristics**

Parameter	Symbol	Values			Unit	Note / Test Condition
		Min.	Typ.	Max.		
Drain-source breakdown voltage	$V_{(BR)DSS}$	650			V	$V_{GS} = 0V, I_D = 1mA$
Gate threshold voltage	$V_{GS(th)}$	3.5	4	4.5	V	$V_{DS} = V_{GS}, I_D = 0.3445mA$
Zero gate voltage drain current	$I_{DSS}$			5	$\mu A$	$V_{DS} = 650V, V_{GS} = 0V, T_j = 25^\circ C$
			600			$V_{DS} = 650V, V_{GS} = 0V, T_j = 150^\circ C$
Gate-source leakage current	$I_{GSS}$			100	nA	$V_{GS} = 20V, V_{DS} = 0V$
Drain-source on-state resistance	$R_{DS(on)}$		0.378	0.42	$\Omega$	$V_{GS} = 10V, I_D = 3.4A, T_j = 25^\circ C$
			0.983			$V_{GS} = 10V, I_D = 3.4A, T_j = 150^\circ C$
Gate resistance	$R_G$		4		$\Omega$	$f = 1MHz, \text{open drain}$

**Table 5 Dynamic characteristics**

Parameter	Symbol	Values			Unit	Note / Test Condition
		Min.	Typ.	Max.		
Input capacitance	$C_{iss}$		870		pF	$V_{GS} = 0V, V_{DS} = 100V, f = 1MHz$
Output capacitance	$C_{oss}$		45		pF	
Effective output capacitance, energy related <sup>1)</sup>	$C_{o(er)}$		36		pF	$V_{GS} = 0V, V_{DS} = 0 \dots 400V$
Effective output capacitance, time related <sup>2)</sup>	$C_{o(tr)}$		161		pF	$I_D = \text{constant}, V_{GS} = 0V, V_{DS} = 0 \dots 400V$
Turn-on delay time	$t_{d(on)}$		10		ns	$V_{DD} = 400V, V_{GS} = 13V, I_D = 5.2A, R_G = 3.4\Omega$
Rise time	$t_r$		7		ns	
Turn-off delay time	$t_{d(off)}$		38		ns	
Fall time	$t_f$		8		ns	

**Table 6 Gate charge characteristics**

Parameter	Symbol	Values			Unit	Note / Test Condition
		Min.	Typ.	Max.		
Gate to source charge	$Q_{gs}$		5.5		nC	$V_{DD} = 480V, I_D = 5.2A, V_{GS} = 0 \text{ to } 10V$
Gate to drain charge	$Q_{gd}$		17.5		nC	
Gate charge total	$Q_g$		32		nC	
Gate plateau voltage	$V_{plateau}$		6.4		V	

<sup>1)</sup>  $C_{o(er)}$  is a fixed capacitance that gives the same stored energy as  $C_{oss}$  while  $V_{DS}$  is rising from 0 to 400V

<sup>2)</sup>  $C_{o(tr)}$  is a fixed capacitance that gives the same charging time as  $C_{oss}$  while  $V_{DS}$  is rising from 0 to 400V

**Table 7 Reverse diode characteristics**

Parameter	Symbol	Values			Unit	Note / Test Condition
		Min.	Typ.	Max.		
Diode forward voltage	$V_{SD}$		0.9		V	$V_{GS} = 0V, I_F = 5.2A, T_j = 25^\circ C$
Reverse recovery time	$t_{rr}$		90		ns	$V_R = 400V, I_F = 5.2A,$ $di_F/dt = 100A/\mu s$ (see table 8)
Reverse recovery charge	$Q_{rr}$		0.3		$\mu C$	
Peak reverse recovery current	$I_{rrm}$		6.2		A	

### 5 Electrical characteristics diagrams

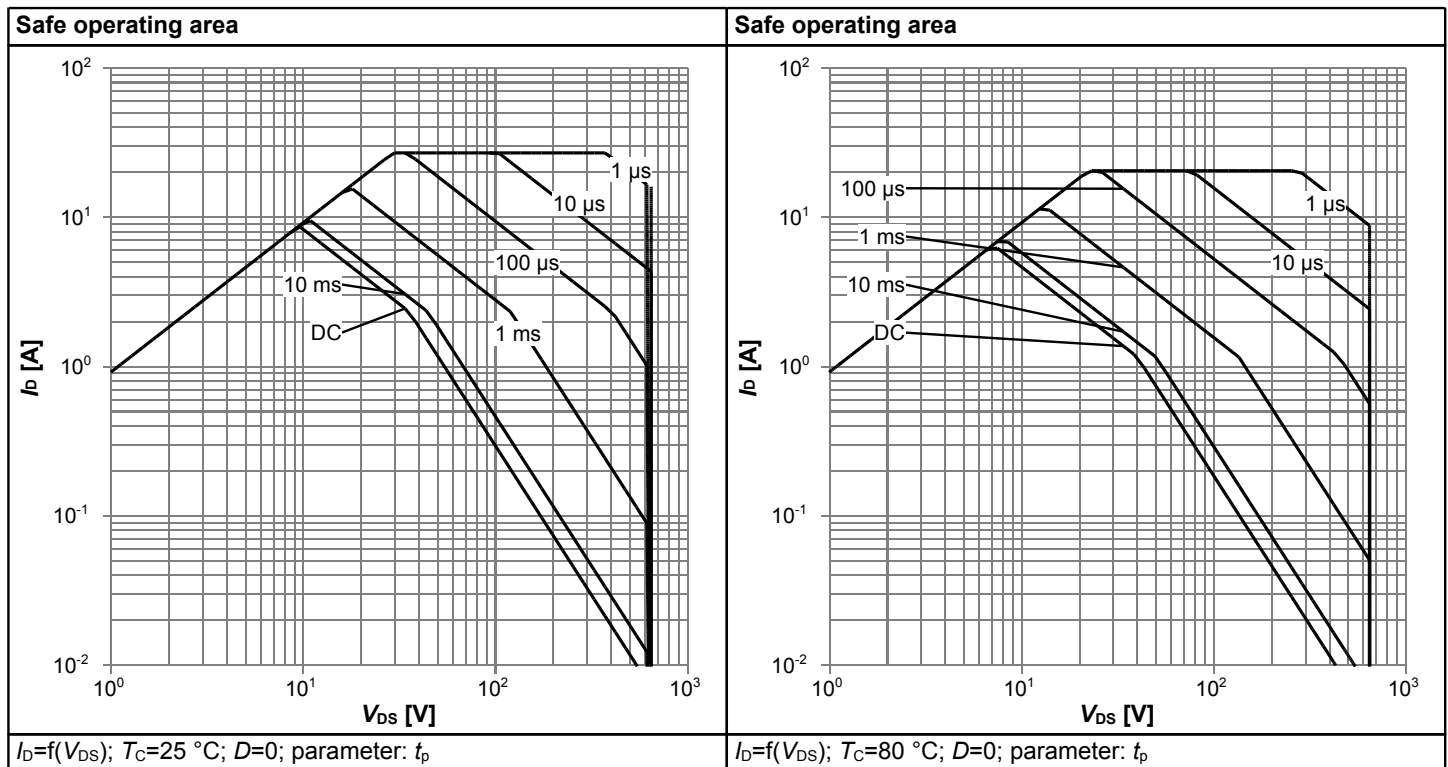
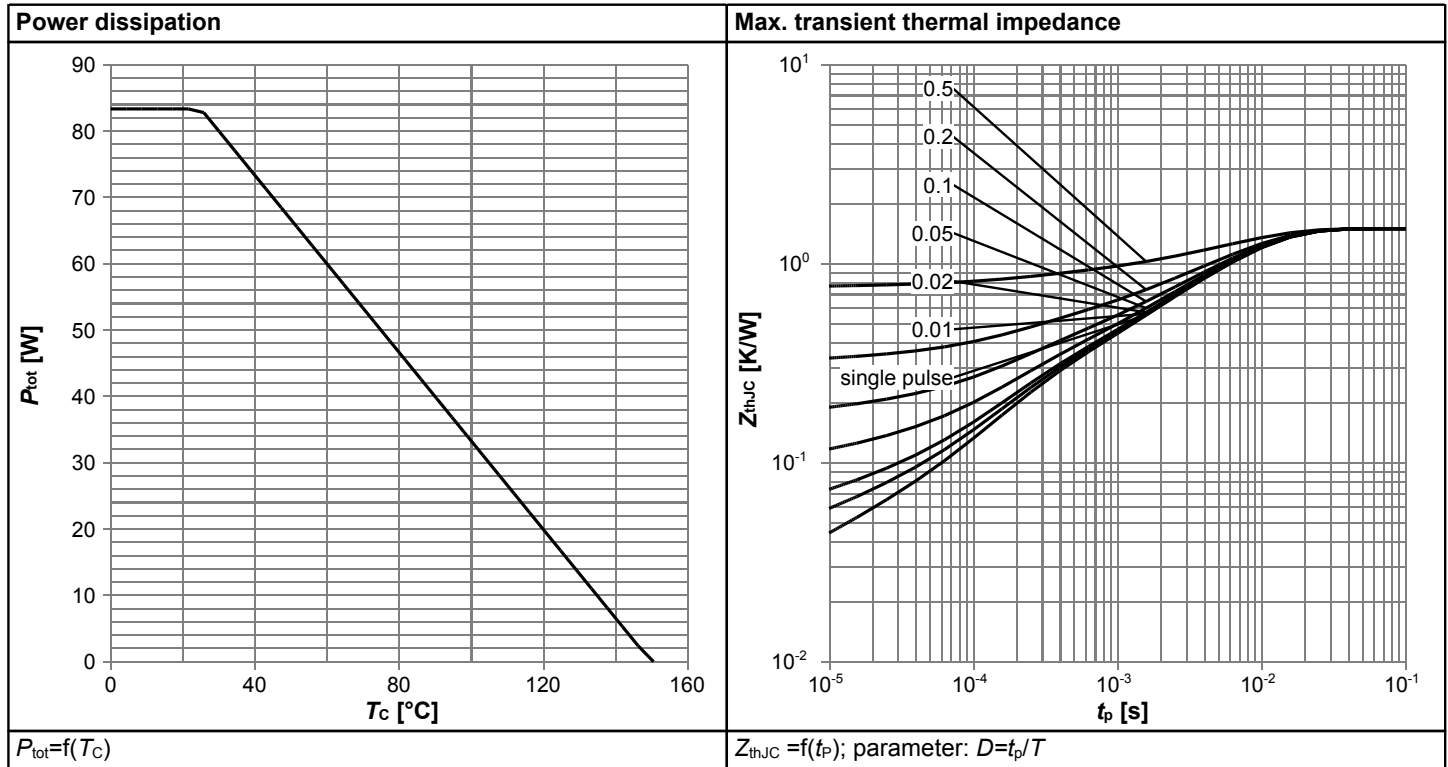



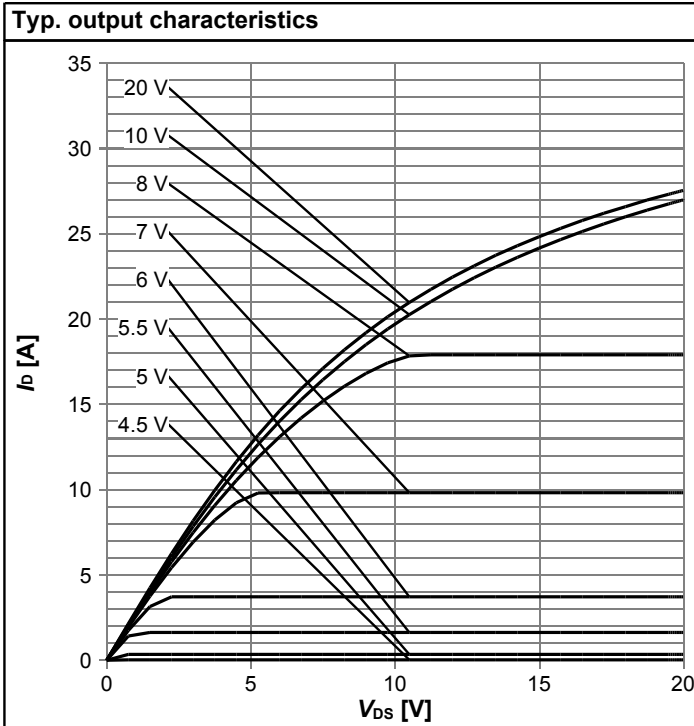

$I_D=f(V_{DS}); T_j=25\text{ °C};$  parameter:  $V_{GS}$

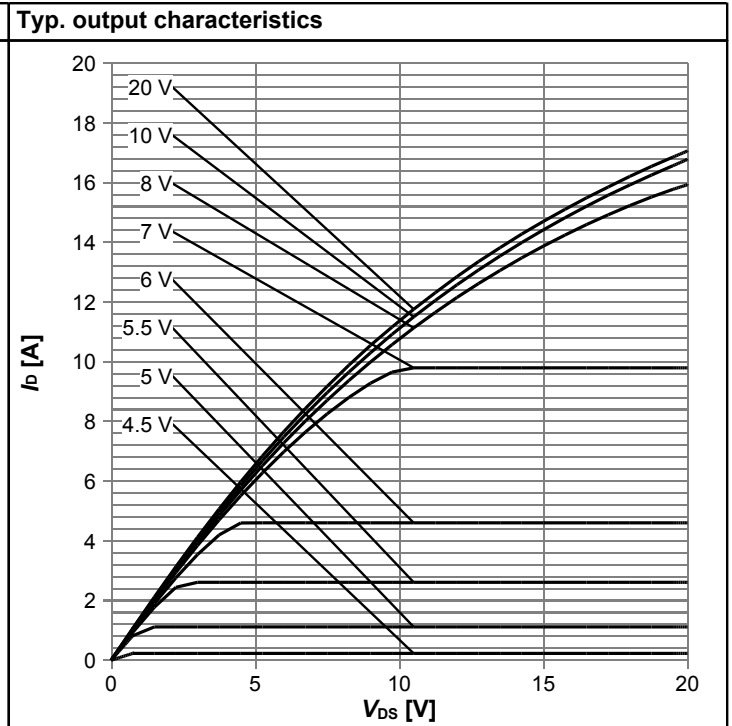

$I_D=f(V_{DS}); T_j=125\text{ °C};$  parameter:  $V_{GS}$

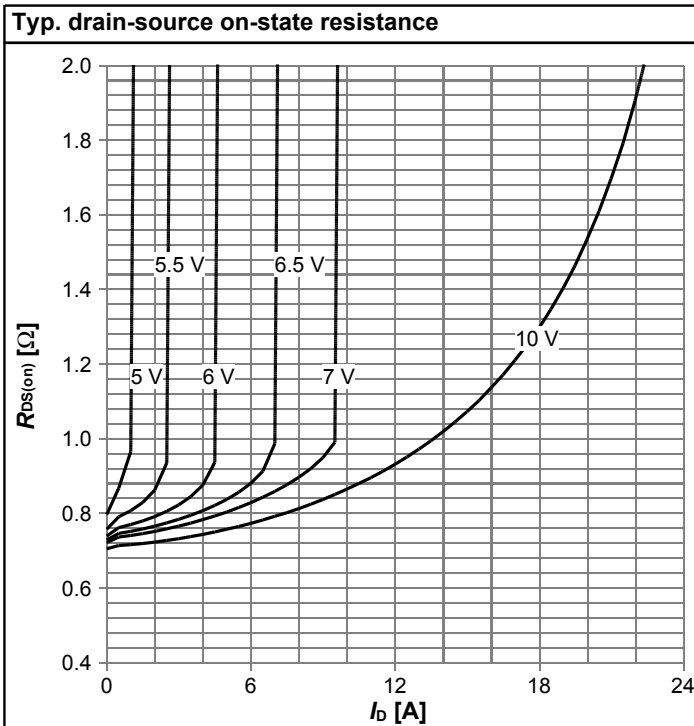

$R_{DS(on)}=f(I_D); T_j=125\text{ °C};$  parameter:  $V_{GS}$

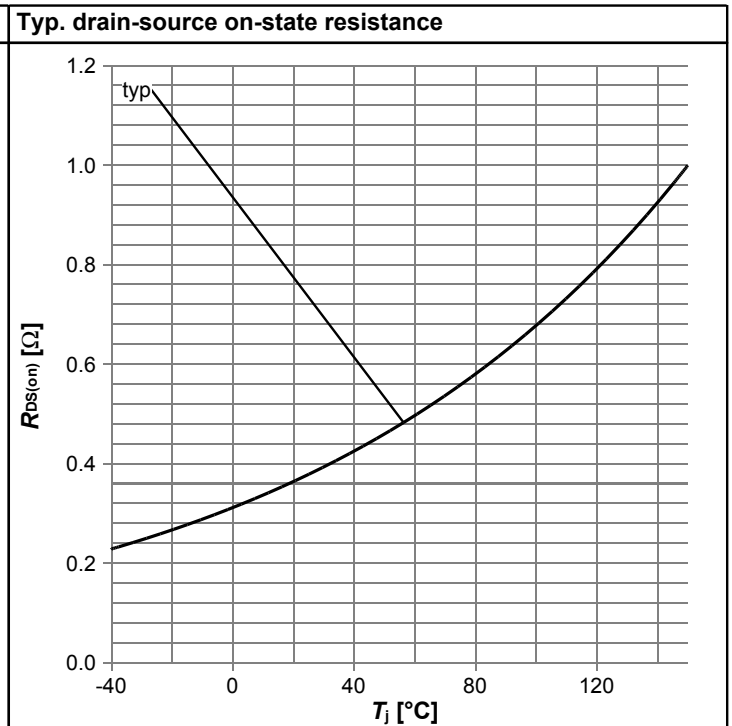

$R_{DS(on)}=f(T_j); I_D=18.1\text{ A}; V_{GS}=10\text{ V}$

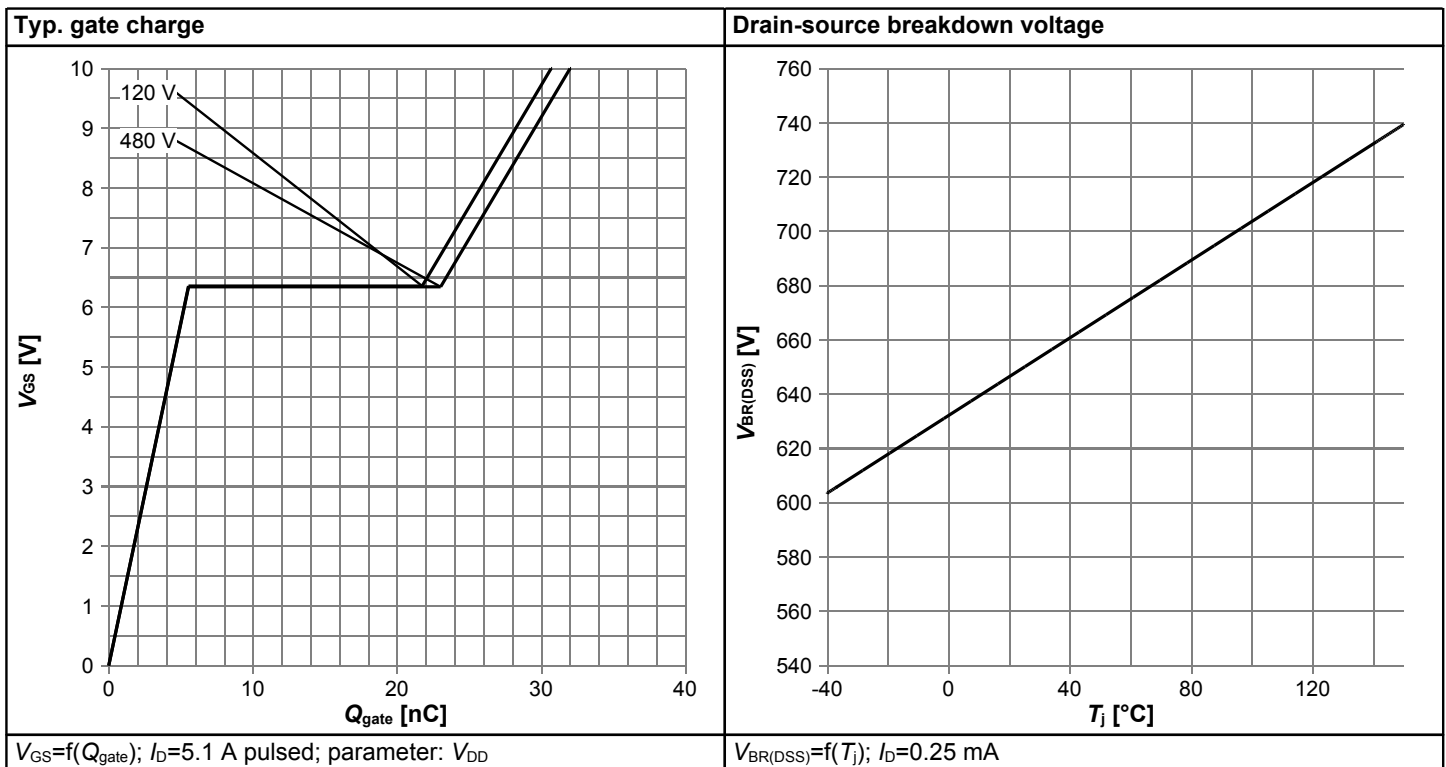
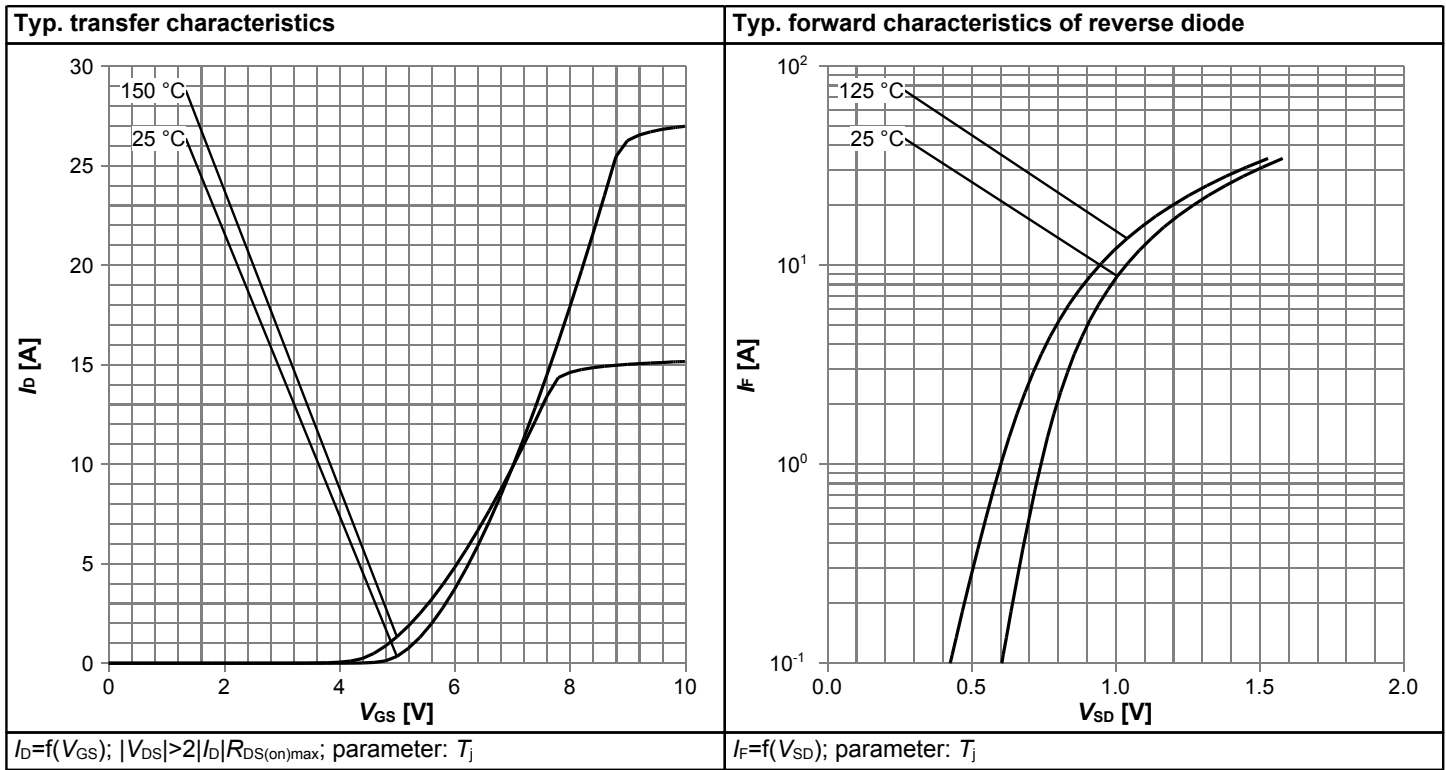

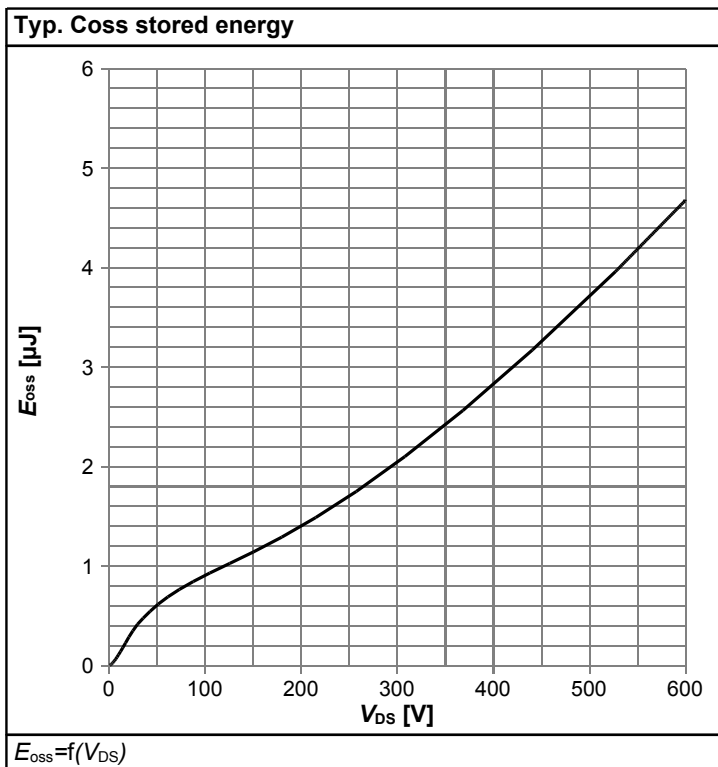
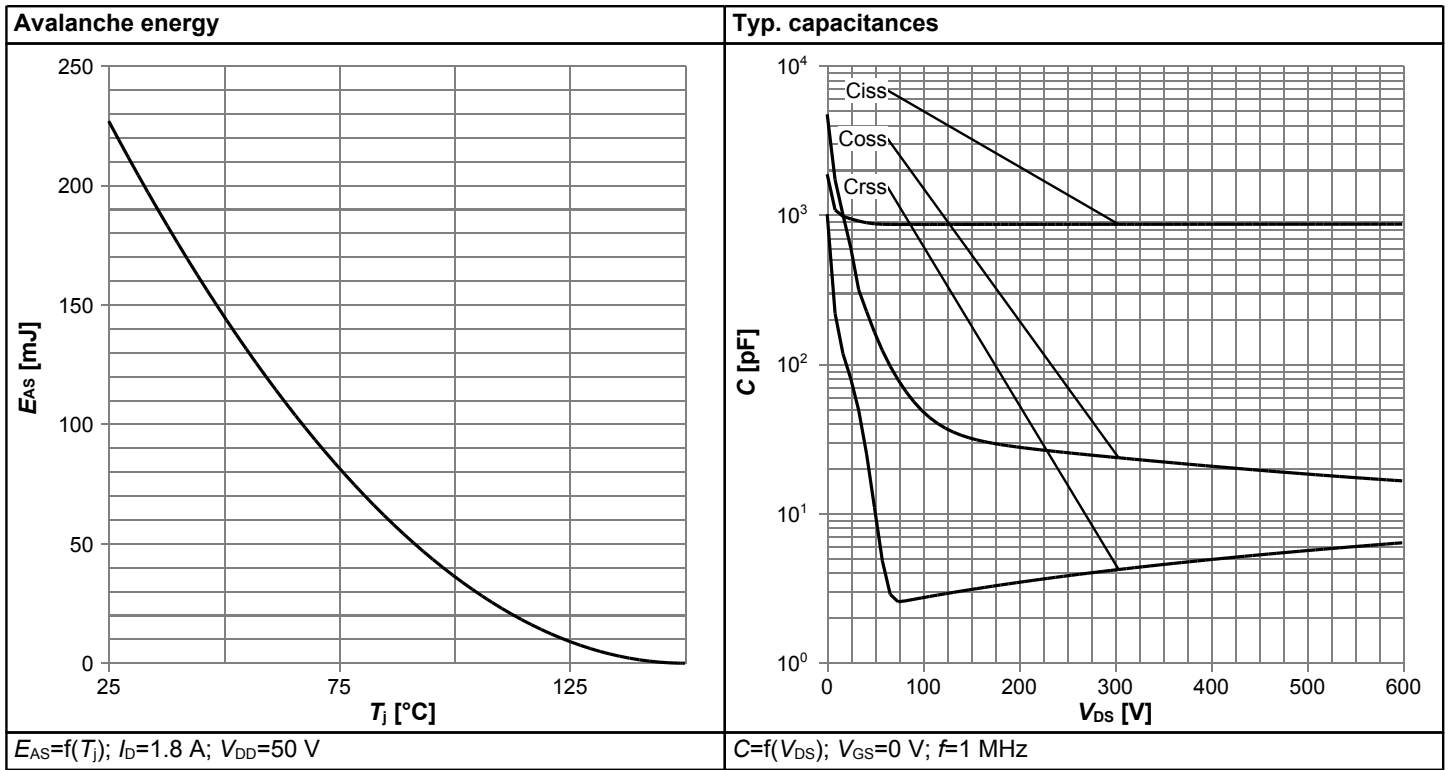

## 6 Test Circuits

**Table 8 Diode characteristics**

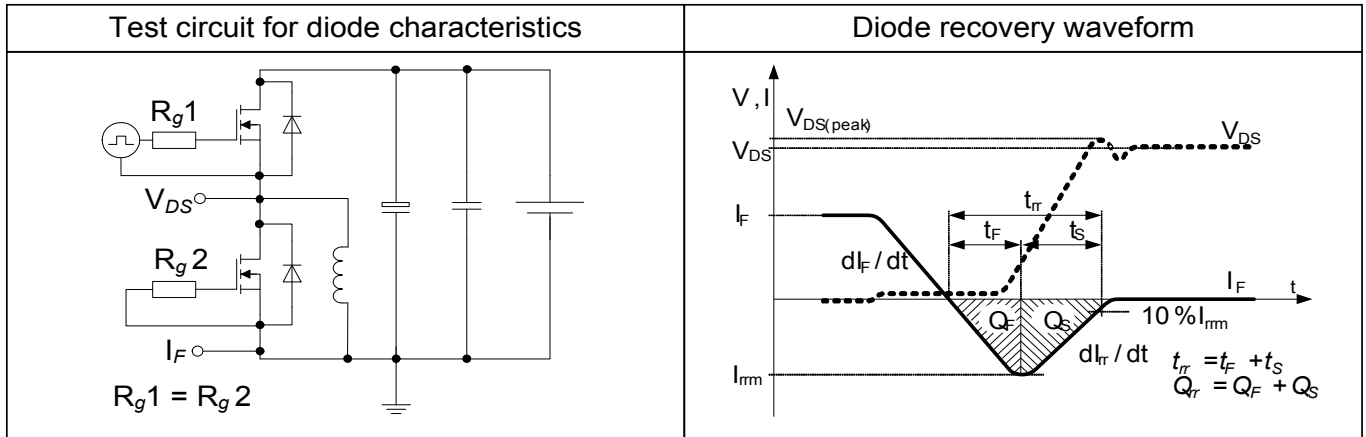

**Table 9 Switching times**

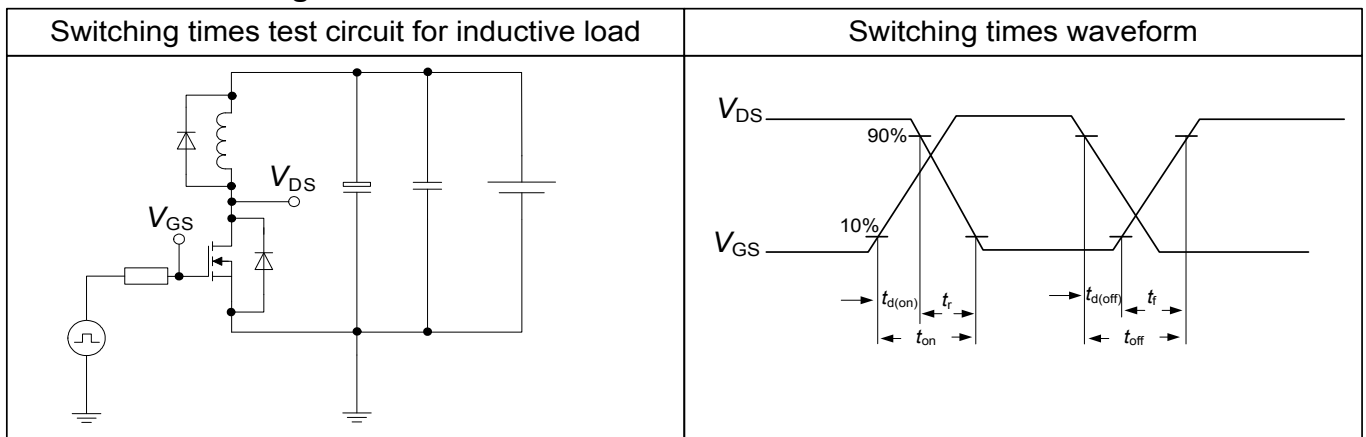

**Table 10 Unclamped inductive load**

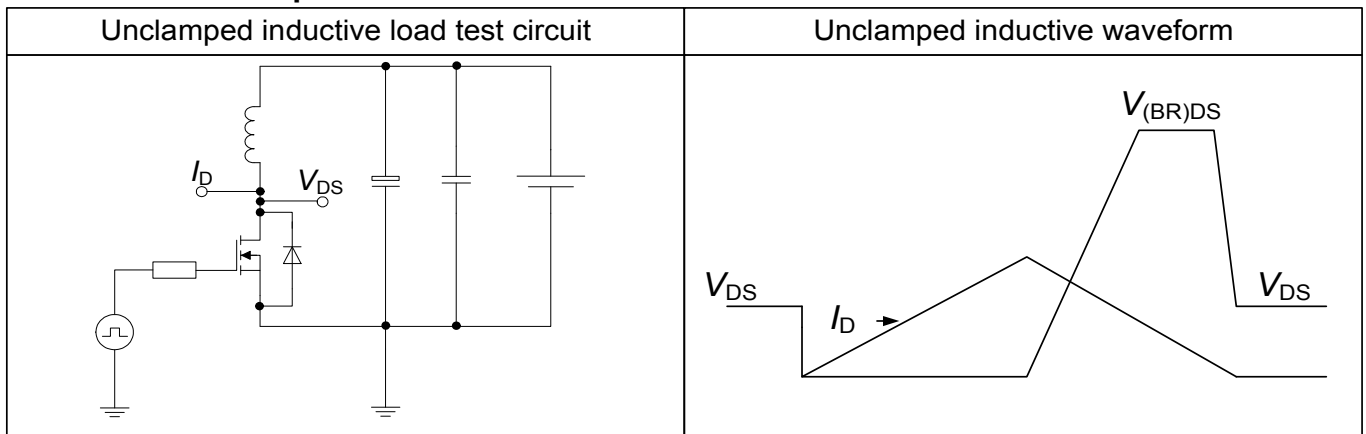

7 Package Outlines

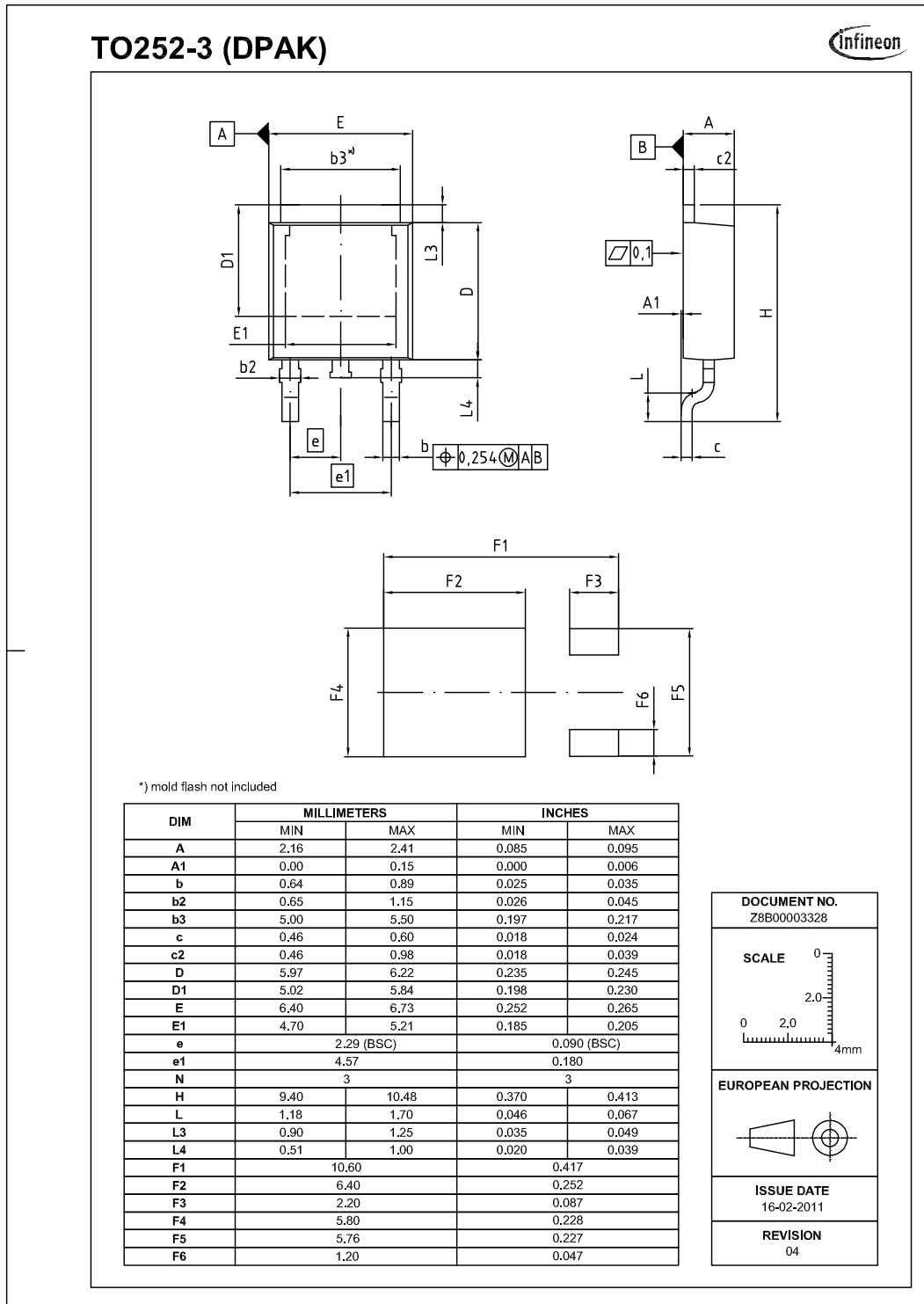

Figure 1 Outline PG-TO 252, dimensions in mm/inches

## Revision History

IPD65R420CFDA

**Revision: 2015-02-11, Rev. 2.1**

Previous Revision

Revision	Date	Subjects (major changes since last revision)
2.0	2012-07-12	Preliminary
2.1	2015-02-11	Correction of Marking Code

### Disclaimer ATV

#### We Listen to Your Comments

Any information within this document that you feel is wrong, unclear or missing at all? Your feedback will help us to continuously improve the quality of this document. Please send your proposal (including a reference to this document) to:

[erratum@infineon.com](mailto:erratum@infineon.com)

**Edition 2011-09-30**

**Published by**

**Infineon Technologies AG**

**81726 München, Germany**

**© 2011 Infineon Technologies AG**

**All Rights Reserved.**

### Legal Disclaimer

The information given in this document shall in no event be regarded as a guarantee of conditions or characteristics ("Beschaffenheitsgarantie"). With respect to any examples or hints given herein, any typical values stated herein and/or any information regarding the application of the device, Infineon Technologies hereby disclaims any and all warranties and liabilities of any kind, including without limitation warranties of non-infringement of intellectual property rights of any third party.

### Information

For further information on technology, delivery terms and conditions and prices please contact your nearest Infineon Technologies Office ([www.infineon.com](http://www.infineon.com)).

### Warnings

Due to technical requirements components may contain dangerous substances. For information on the types in question please contact your nearest Infineon Technologies Office.

Infineon Technologies Components may only be used in life-support devices or systems with the express written approval of Infineon Technologies, if a failure of such components can reasonably be expected to cause the failure of that life-support device or system, or to affect the safety or effectiveness of that device or system. Life support devices or systems are intended to be implanted in the human body, or to support and/or maintain and sustain and/or protect human life.

If they fail, it is reasonable to assume that the health of the user or other persons may be endangered.