

MOSFET

Metal Oxide Semiconductor Field Effect Transistor

CoolMOS™ C6

650V CoolMOS™ C6 Power Transistor
IPL65R1K5C6S

Data Sheet

Rev. 2.0
Final

1 Description

CoolMOS™ is a revolutionary technology for high voltage power MOSFETs, designed according to the superjunction (SJ) principle and pioneered by Infineon Technologies. CoolMOS™ C6 series combines the experience of the leading SJ MOSFET supplier with high class innovation. The offered devices provide all benefits of a fast switching SJ MOSFET while not sacrificing ease of use. Extremely low switching and conduction losses make switching applications even more efficient, more compact, lighter and cooler.

Features

- Extremely low losses due to very low FOM $R_{DS(on)} \cdot Q_g$ and E_{oss}
- Very high commutation ruggedness
- Easy to use/drive
- Pb-free plating, Halogen free mold compound
- Qualified for industrial grade applications according to JEDEC (J-STD20 and JESD22)

Applications

PFC stages, hard switching PWM stages and resonant switching PWM stages for e.g. PC Silverbox, Adapter, LCD & PDP TV, Lighting, Server, Telecom and UPS.

Please note: For MOSFET paralleling the use of ferrite beads on the gate or separate totem poles is generally recommended.

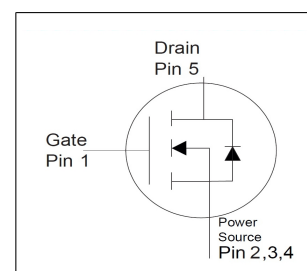
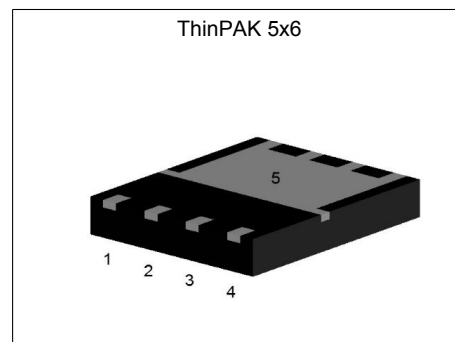

Table 1 Key Performance Parameters

Parameter	Value	Unit
$V_{DS} @ T_{j,max}$	700	V
$R_{DS(on),max}$	1.5	Ω
$Q_{g,typ}$	11	nC
$I_{D,pulse}$	8.4	A
$E_{oss@400V}$	1.15	μJ
Body diode di/dt	500	A/ μs

Type / Ordering Code	Package	Marking	Related Links
IPL65R1K5C6S	ThinPAK 5x6 SMD	65C61K5	see Appendix A

Table of Contents

Description	2
Maximum ratings	4
Thermal characteristics	4
Electrical characteristics	5
Electrical characteristics diagrams	7
Test Circuits	11
Package Outlines	12
Appendix A	13
Revision History	14
Disclaimer	14

2 Maximum ratings

at $T_j = 25^\circ\text{C}$, unless otherwise specified

Table 2 Maximum ratings

Parameter	Symbol	Values			Unit	Note / Test Condition
		Min.	Typ.	Max.		
Continuous drain current ¹⁾	I_D	-	-	3 1.9	A	$T_C = 25^\circ\text{C}$ $T_C = 100^\circ\text{C}$
Pulsed drain current ²⁾	$I_{D,pulse}$	-	-	8.4	A	$T_C=25^\circ\text{C}$
Avalanche energy, single pulse	E_{AS}	-	-	26	mJ	$I_D=0.6\text{A}$; $V_{DD} = 50\text{V}$
Avalanche energy, repetitive	E_{AR}	-	-	0.10	mJ	$I_D=0.6\text{A}$; $V_{DD} = 50\text{V}$
Avalanche current, repetitive	I_{AR}	-	-	0.6	A	-
MOSFET dv/dt ruggedness	dv/dt	-	-	50	V/ns	$V_{DS} = 0\dots 520\text{V}$
Gate source voltage	V_{GS}	-20 -30	-	20 30	V	static; AC ($f > 1\text{ Hz}$)
Power dissipation (non FullPAK)	P_{tot}	-	-	26.6	W	$T_C=25^\circ\text{C}$
Operating and storage temperature	T_j, T_{stg}	-40	-	150	$^\circ\text{C}$	-
Continuous diode forward current	I_S	-	-	2.6	A	$T_C=25^\circ\text{C}$
Diode pulse current ²⁾	$I_{S,pulse}$	-	-	7.5	A	$T_C = 25^\circ\text{C}$
Reverse diode dv/dt ³⁾	dv/dt	-	-	15	V/ns	$V_{DS} = 0\dots 400\text{V}$, $I_{SD} \leq I_S$, $T_j=25^\circ\text{C}$
Maximum diode commutation speed ³⁾	di_f/dt	-	-	500	A/ μs	$V_{DS} = 0\dots 400\text{V}$, $I_{SD} \leq I_S$, $T_j=25^\circ\text{C}$

3 Thermal characteristics

Table 3 Thermal characteristics (non FullPAK)

Parameter	Symbol	Values			Unit	Note / Test Condition
		Min.	Typ.	Max.		
Thermal resistance, junction - case	R_{thJC}	-	-	4.7	$^\circ\text{C/W}$	-
Thermal resistance, junction - ambient	R_{thJA}	-	35	62	$^\circ\text{C/W}$	Device on 40mm*40mm*1.5 epoxy PCB FR4 with 6cm ² (one layer 70 μm thick) copper area for drain connection and cooling. PCB is vertical without blown air.
Soldering temperature, wavesoldering only allowed at leads	T_{sold}	-	-	260	$^\circ\text{C}$	reflow MSL1

¹⁾ Limited by $T_{j,max}$. Maximum duty cycle $D=0.75$

²⁾ Pulse width t_p limited by $T_{j,max}$

³⁾ $V_{DClink}=400\text{V}$; $V_{DS,peak} < V_{(BR)DSS}$; identical low side and high side switch with identical R_G

4 Electrical characteristics

Table 4 Static characteristics

Parameter	Symbol	Values			Unit	Note / Test Condition
		Min.	Typ.	Max.		
Drain-source breakdown voltage	$V_{(BR)DSS}$	650	-	-	V	$V_{GS}=0V, I_D=1mA$
Gate threshold voltage	$V_{(GS)th}$	2.50	3	3.50	V	$V_{DS}=V_{GS}, I_D=0.1mA$
Zero gate voltage drain current	I_{DSS}	-	-	1	μA	$V_{DS}=650V, V_{GS}=0V, T_j=25^\circ C$ $V_{DS}=650V, V_{GS}=0V, T_j=150^\circ C$
Gate-source leakage current	I_{GSS}	-	-	100	nA	$V_{GS}=20V, V_{DS}=0V$
Drain-source on-state resistance	$R_{DS(on)}$	-	1.35	1.50	Ω	$V_{GS}=10V, I_D=1A, T_j=25^\circ C$ $V_{GS}=10V, I_D=1A, T_j=150^\circ C$
Gate resistance	R_G	-	6.5	-	Ω	$f=1\text{ MHz}, \text{open drain}$

Table 5 Dynamic characteristics

Parameter	Symbol	Values			Unit	Note / Test Condition
		Min.	Typ.	Max.		
Input capacitance	C_{iss}	-	225	-	pF	$V_{GS}=0V, V_{DS}=100V, f=1MHz$
Output capacitance	C_{oss}	-	18	-	pF	$V_{GS}=0V, V_{DS}=100V, f=1MHz$
Effective output capacitance, energy related ¹⁾	$C_{o(er)}$	-	10	-	pF	$V_{GS}=0V, V_{DS}=0...520V$
Effective output capacitance, time related ²⁾	$C_{o(tr)}$	-	42	-	pF	$I_D=\text{constant}, V_{GS}=0V, V_{DS}=0...520V$
Turn-on delay time	$t_{d(on)}$	-	7.7	-	ns	$V_{DD}=400V, V_{GS}=10V, I_D=1.5A,$ $R_G=10.2\Omega$
Rise time	t_r	-	5.9	-	ns	$V_{DD}=400V, V_{GS}=10V, I_D=1.5A,$ $R_G=10.2\Omega$
Turn-off delay time	$t_{d(off)}$	-	33	-	ns	$V_{DD}=400V, V_{GS}=10V, I_D=1.5A,$ $R_G=10.2\Omega$
Fall time	t_f	-	18.2	-	ns	$V_{DD}=400V, V_{GS}=10V, I_D=1.5A,$ $R_G=10.2\Omega$

Table 6 Gate charge characteristics

Parameter	Symbol	Values			Unit	Note / Test Condition
		Min.	Typ.	Max.		
Gate to source charge	Q_{gs}	-	1.3	-	nC	$V_{DD}=520V, I_D=1.5A, V_{GS}=0\text{ to }10V$
Gate to drain charge	Q_{gd}	-	5.8	-	nC	$V_{DD}=520V, I_D=1.5A, V_{GS}=0\text{ to }10V$
Gate charge total	Q_g	-	11	-	nC	$V_{DD}=520V, I_D=1.5A, V_{GS}=0\text{ to }10V$
Gate plateau voltage	$V_{plateau}$	-	5.4	-	V	$V_{DD}=520V, I_D=1.5A, V_{GS}=0\text{ to }10V$

¹⁾ $C_{o(er)}$ is a fixed capacitance that gives the same stored energy as C_{oss} while V_{DS} is rising from 0 to 80% $V_{(BR)DSS}$
²⁾ $C_{o(tr)}$ is a fixed capacitance that gives the same charging time as C_{oss} while V_{DS} is rising from 0 to 80% $V_{(BR)DSS}$

Table 7 Reverse diode characteristics

Parameter	Symbol	Values			Unit	Note / Test Condition
		Min.	Typ.	Max.		
Diode forward voltage	V_{SD}	-	0.9	-	V	$V_{GS}=0V, I_F=1.5A, T_i=25^\circ C$
Reverse recovery time	t_{rr}	-	200	-	ns	$V_R=400V, I_F=1.5A, di_F/dt=100A/\mu s$
Reverse recovery charge	Q_{rr}	-	0.9	-	μC	$V_R=400V, I_F=1.5A, di_F/dt=100A/\mu s$
Peak reverse recovery current	I_{rrm}	-	8	-	A	$V_R=400V, I_F=1.5A, di_F/dt=100A/\mu s$

5 Electrical characteristics diagrams

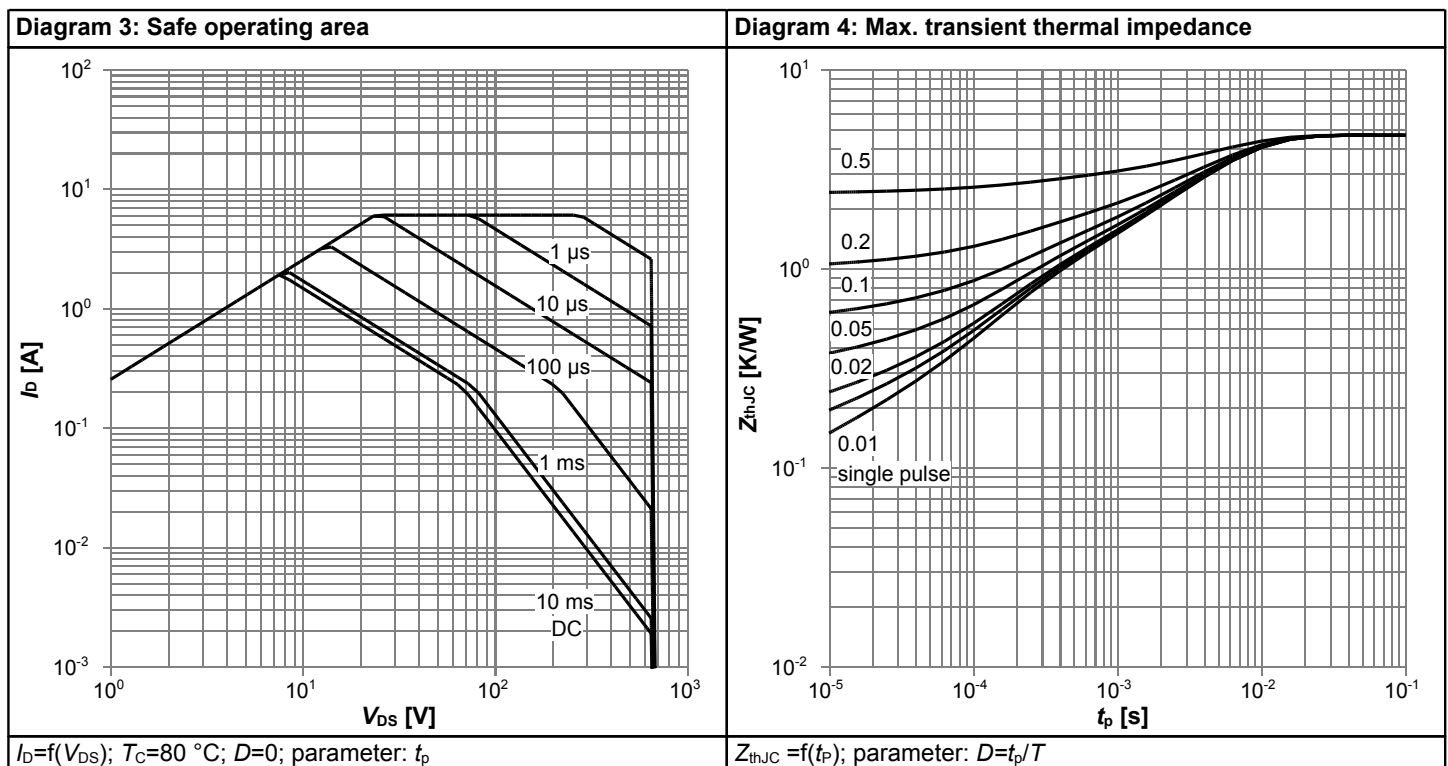
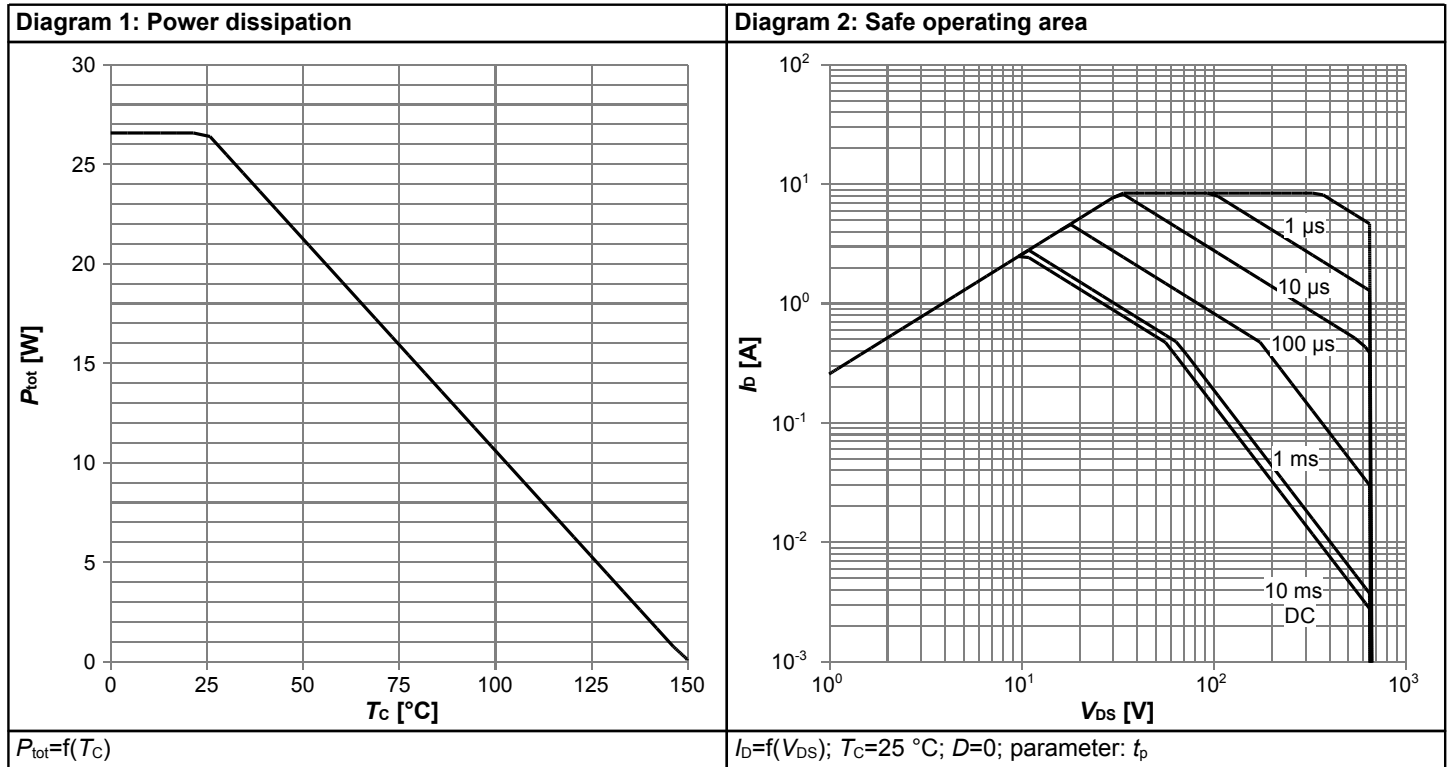
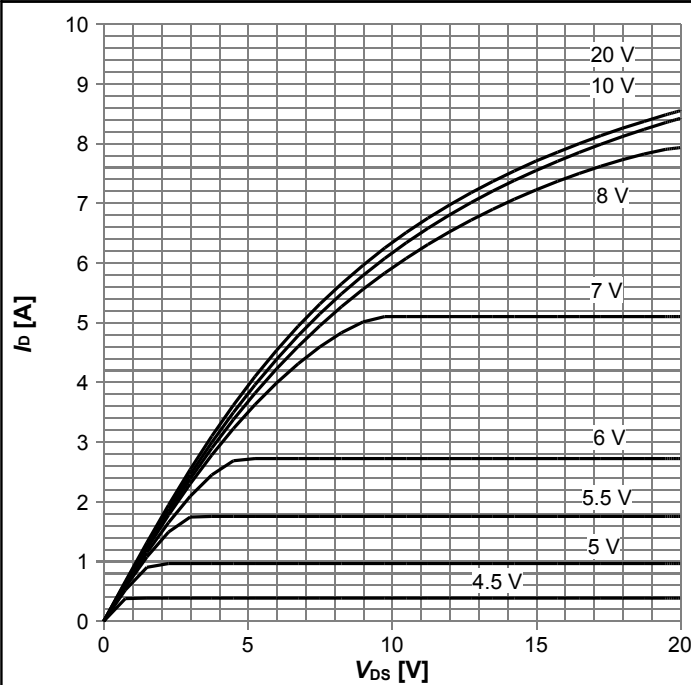
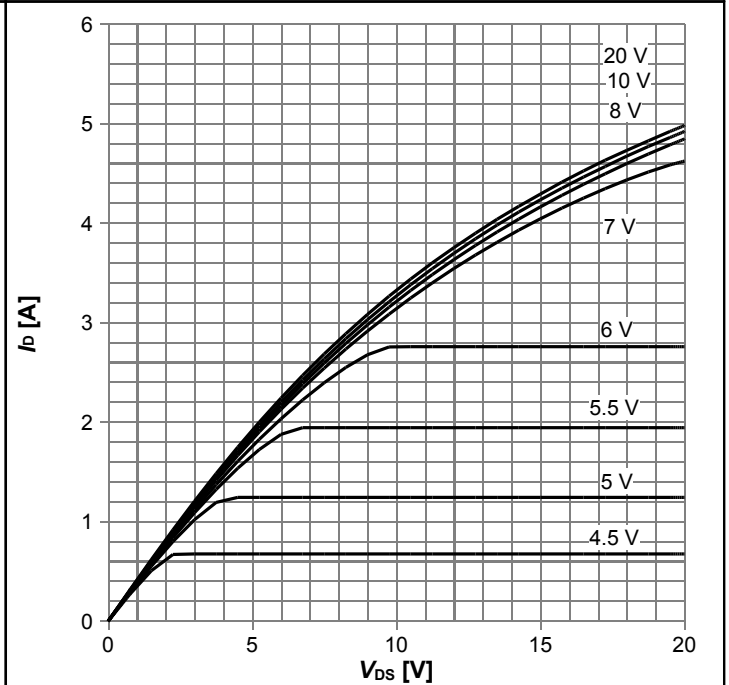

Diagram 5: Typ. output characteristics



$I_D=f(V_{DS}); T_j=25\text{ }^\circ\text{C};$ parameter: V_{GS}

Diagram 6: Typ. output characteristics



$I_D=f(V_{DS}); T_j=125\text{ }^\circ\text{C};$ parameter: V_{GS}

Diagram 7: Typ. drain-source on-state resistance

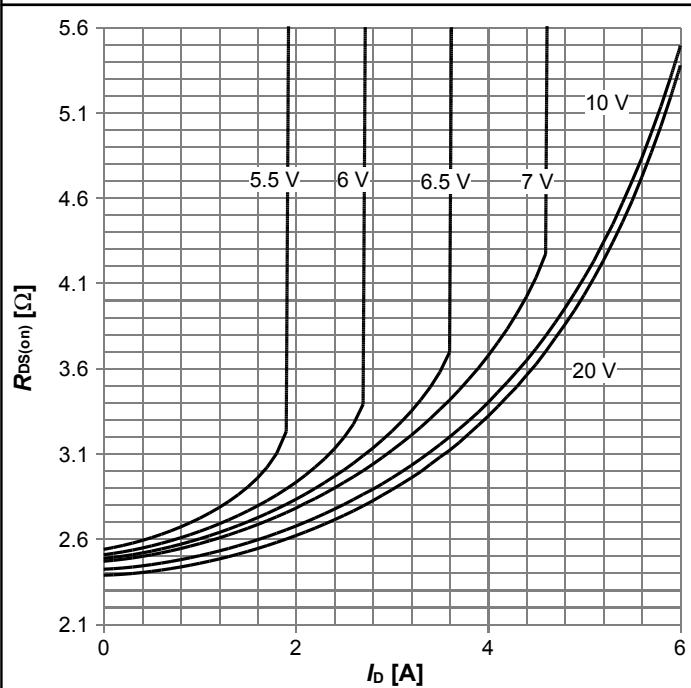

$R_{DS(on)}=f(I_D); T_j=125\text{ }^\circ\text{C};$ parameter: V_{GS}

Diagram 8: Drain-source on-state resistance

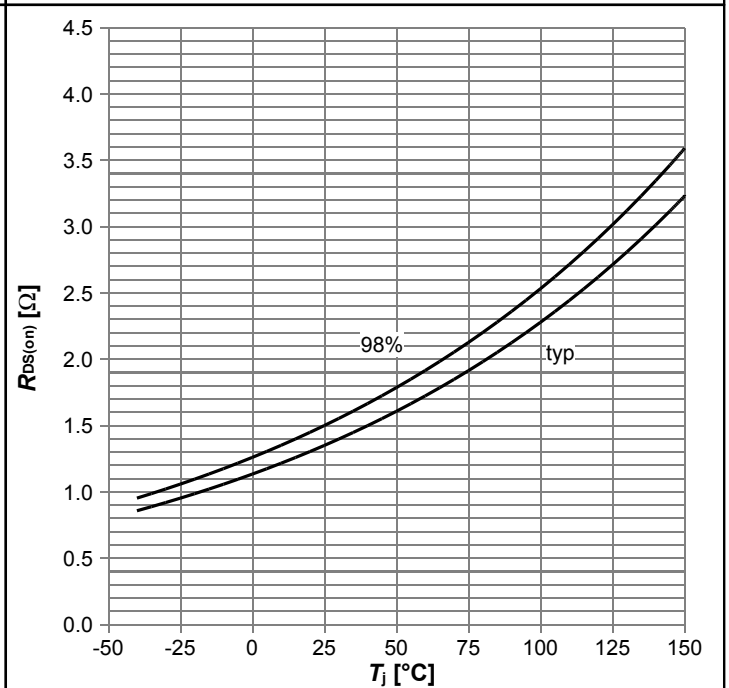

$R_{DS(on)}=f(T_j); I_D=1\text{ A}; V_{GS}=10\text{ V}$

Diagram 9: Typ. transfer characteristics

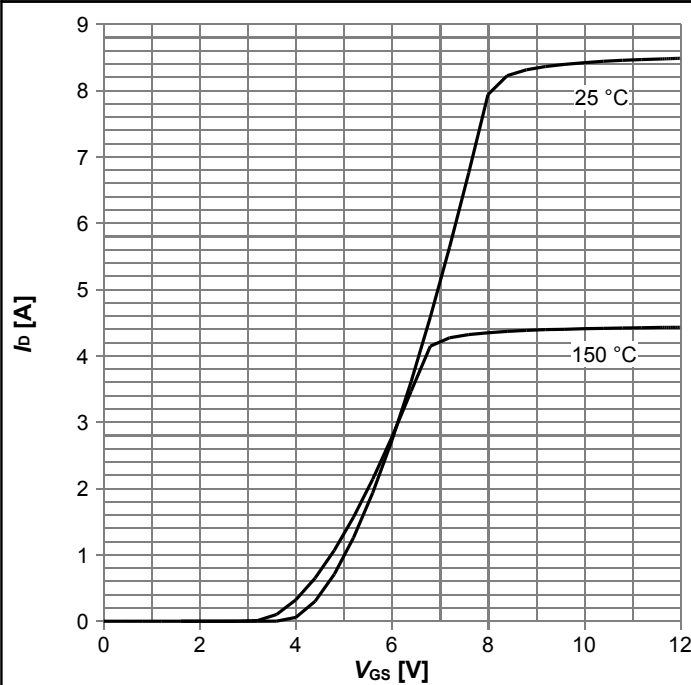

$I_D=f(V_{GS}); V_{DS}=20V; \text{parameter: } T_j$

Diagram 10: Typ. gate charge

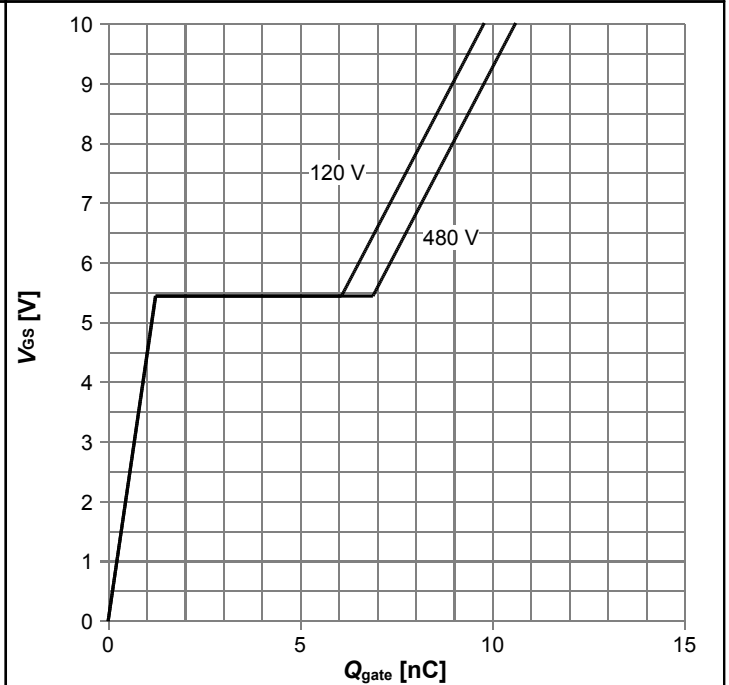

$V_{GS}=f(Q_{gate}); I_D=1.5 \text{ A pulsed}; \text{parameter: } V_{DD}$

Diagram 11: Forward characteristics of reverse diode

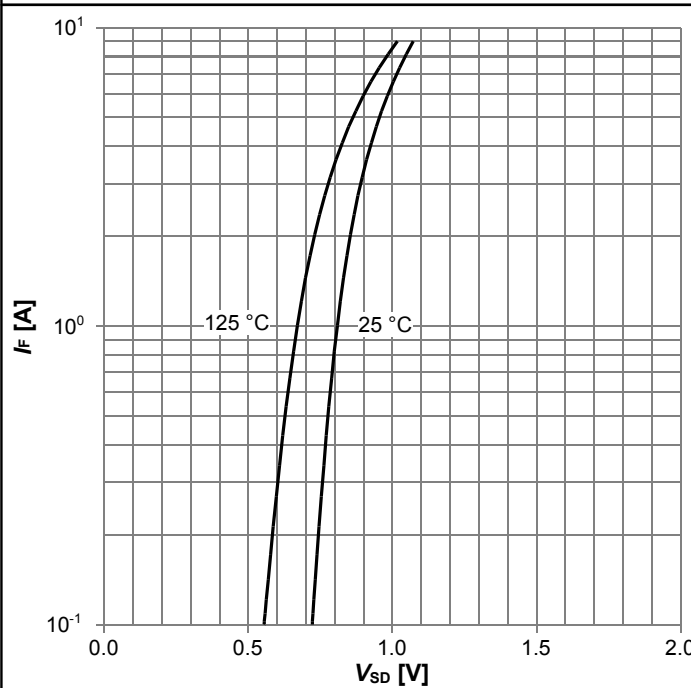

$I_F=f(V_{SD}); \text{parameter: } T_j$

Diagram 12: Avalanche energy

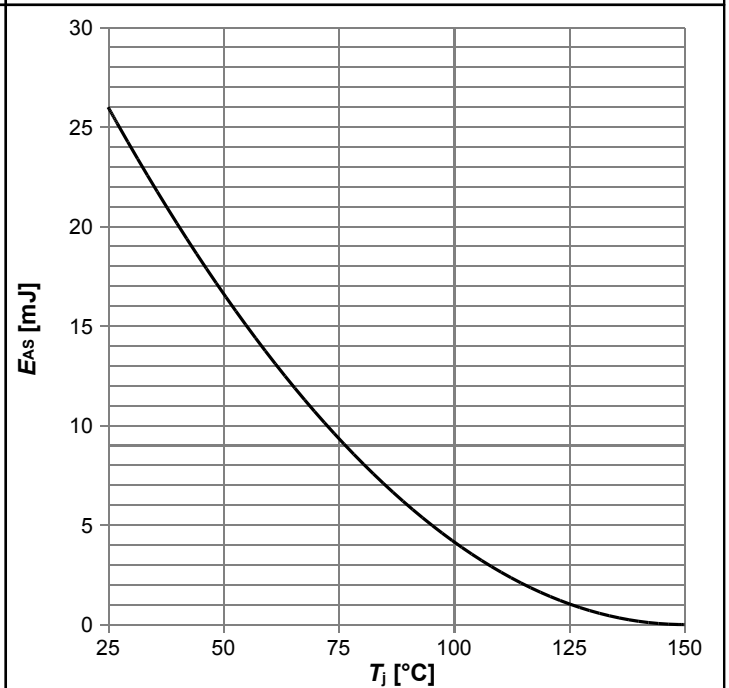

$E_{AS}=f(T_j); I_D=0.6 \text{ A}; V_{DD}=50 \text{ V}$

Diagram 13: Drain-source breakdown voltage

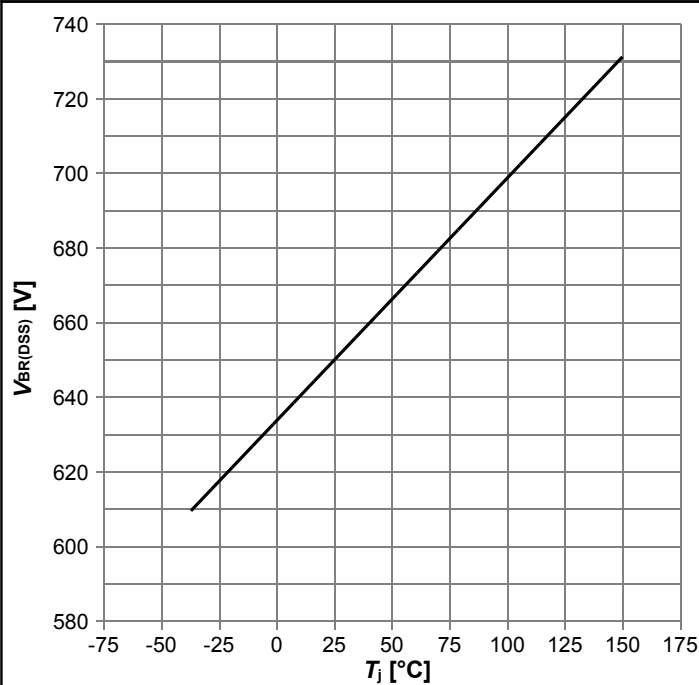

$V_{BR(DSS)}=f(T_j); I_D=1 \text{ mA}$

Diagram 14: Typ. capacitances

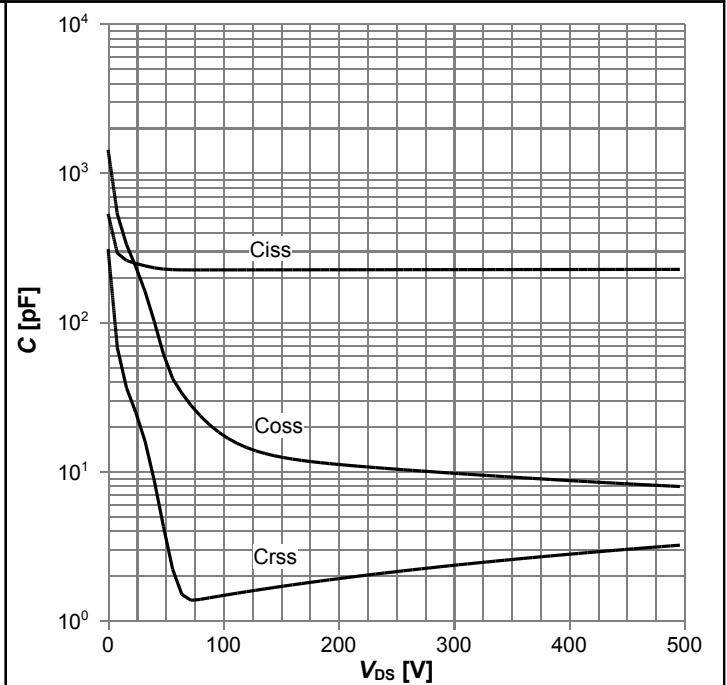

$C=f(V_{DS}); V_{GS}=0 \text{ V}; f=1 \text{ MHz}$

Diagram 15: Typ. Coss stored energy

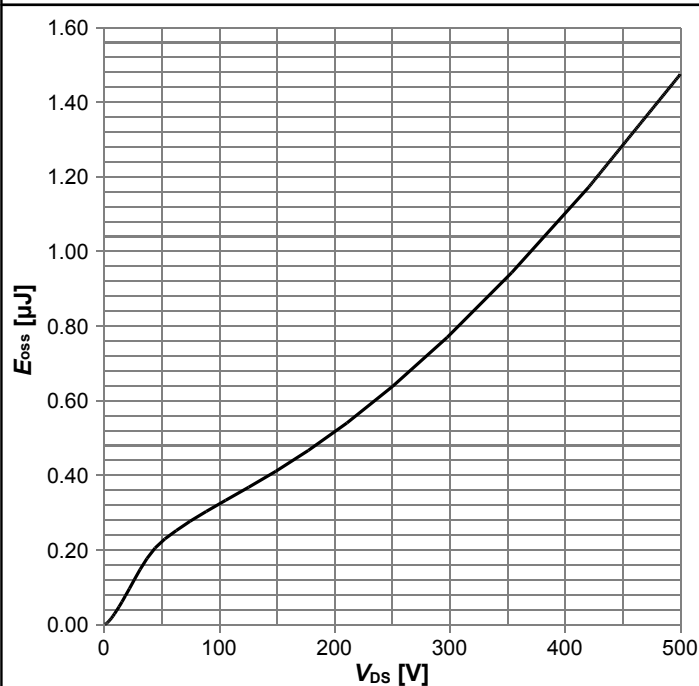

$E_{oss}=f(V_{DS})$

6 Test Circuits

Table 8 Diode characteristics

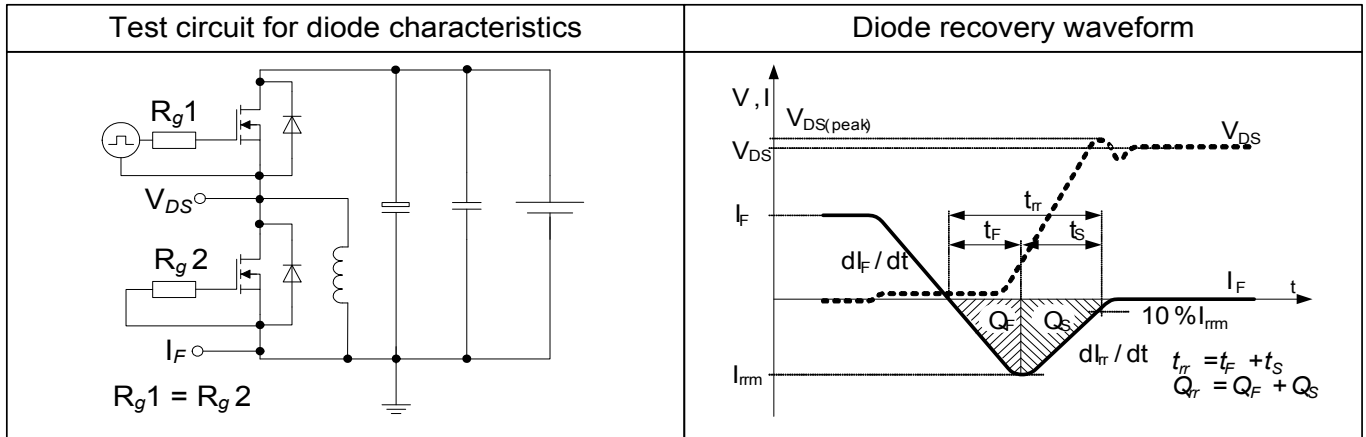

Table 9 Switching times

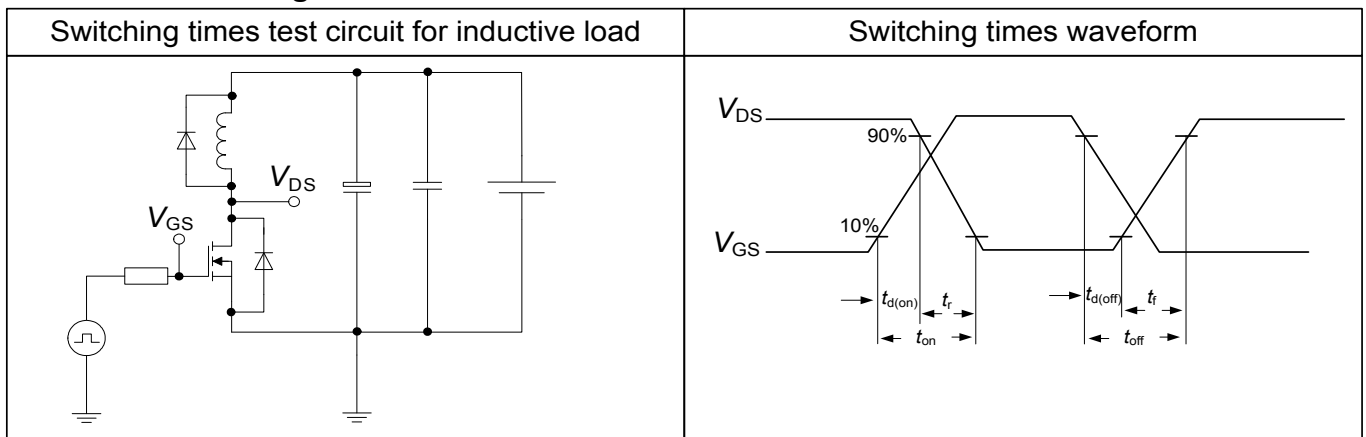
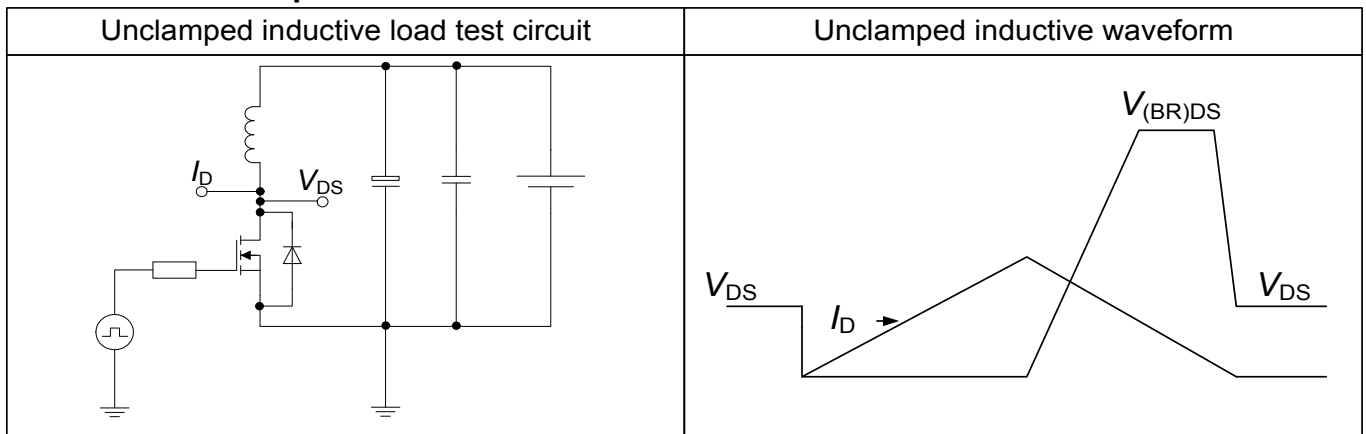

Table 10 Unclamped inductive load



7 Package Outlines

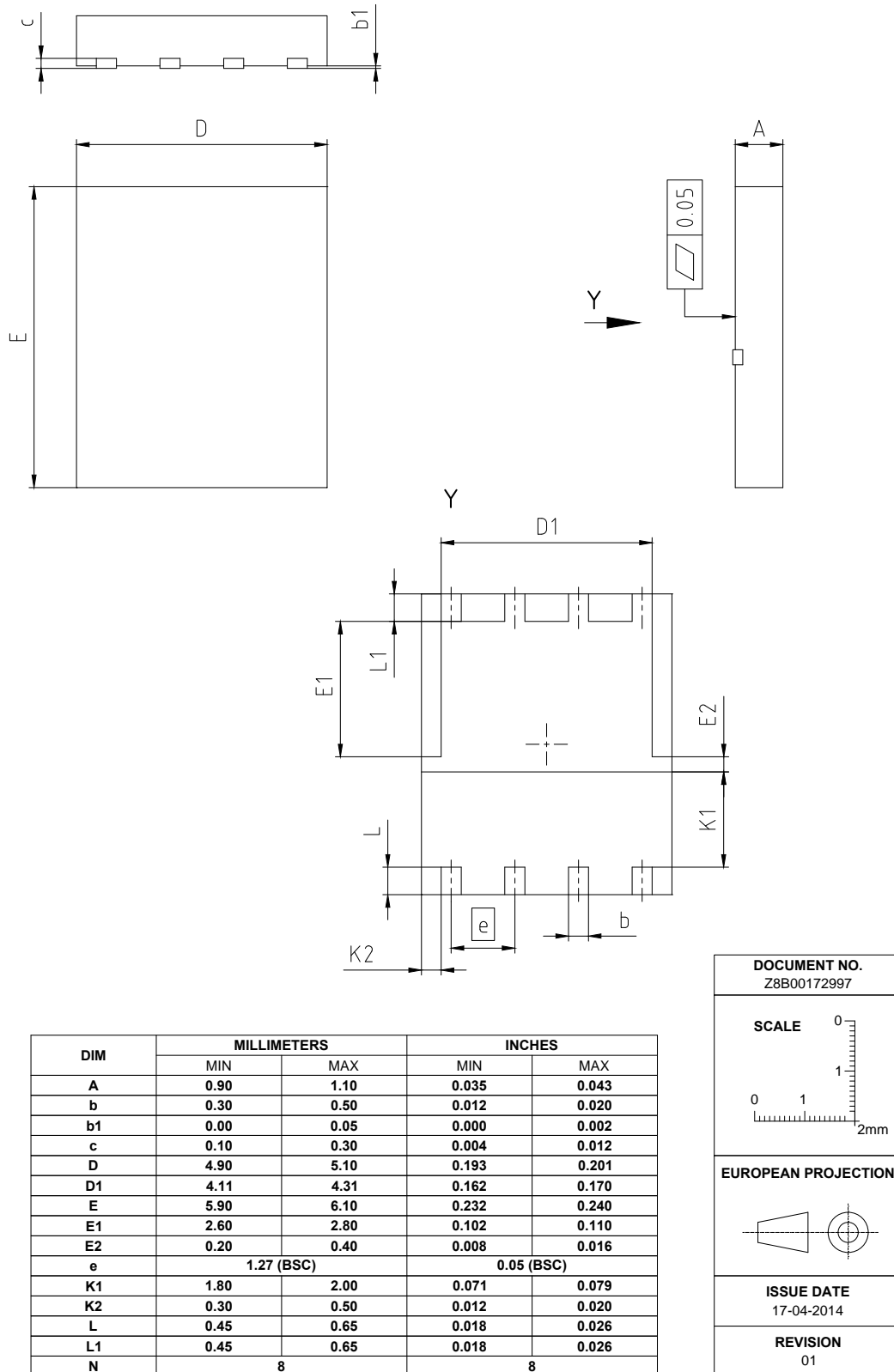

Figure 1 Outline ThinPAK 5x6 SMD, dimensions in mm/inches

8 Appendix A

Table 11 Related Links

- IFX CoolMOS Webpage: www.infineon.com
- IFX Design tools: www.infineon.com

Revision History

IPL65R1K5C6S

Revision: 2014-07-08, Rev. 2.0

Previous Revision

Revision	Date	Subjects (major changes since last revision)
2.0	2014-07-08	Release of final version

We Listen to Your Comments

Any information within this document that you feel is wrong, unclear or missing at all? Your feedback will help us to continuously improve the quality of this document. Please send your proposal (including a reference to this document) to:

erratum@infineon.com

Published by

Infineon Technologies AG

81726 München, Germany

© 2014 Infineon Technologies AG

All Rights Reserved.

Legal Disclaimer

The information given in this document shall in no event be regarded as a guarantee of conditions or characteristics. With respect to any examples or hints given herein, any typical values stated herein and/or any information regarding the application of the device, Infineon Technologies hereby disclaims any and all warranties and liabilities of any kind, including without limitation, warranties of non-infringement of intellectual property rights of any third party.

Information

For further information on technology, delivery terms and conditions and prices please contact your nearest Infineon Technologies Office (www.infineon.com).

Warnings

Due to technical requirements, components may contain dangerous substances. For information on the types in question, please contact the nearest Infineon Technologies Office.

The Infineon Technologies component described in this Data Sheet may be used in life-support devices or systems and/or automotive, aviation and aerospace applications or systems only with the express written approval of Infineon Technologies, if a failure of such components can reasonably be expected to cause the failure of that life-support, automotive, aviation and aerospace device or system or to affect the safety or effectiveness of that device or system. Life support devices or systems are intended to be implanted in the human body or to support and/or maintain and sustain and/or protect human life. If they fail, it is reasonable to assume that the health of the user or other persons may be endangered.