

MOSFET

Metal Oxide Semiconductor Field Effect Transistor

CoolMOS™ CFD2 650V Thinpak

650V CoolMOS™ CFD2 Power Transistor
IPL65R725CFD

Data Sheet

Rev. 2.0
Final

Industrial & Multimarket

1 Description

CoolMOS™ is a revolutionary technology for high voltage power MOSFETs, designed according to the superjunction (SJ) principle and pioneered by Infineon Technologies. 650V CoolMOS™ CFD2 series combines the experience of the leading SJ MOSFET supplier with high class innovation. The resulting devices provide all benefits of a fast switching SJ MOSFET while offering an extremely fast and robust body diode. This combination of extremely low switching, commutation and conduction losses together with highest robustness make especially resonant switching applications more reliable, more efficient, lighter and cooler.

ThinPAK

ThinPAK is a new leadless SMD package for HV MOSFETs. The new package has a very small footprint of only 64mm² (vs. 150mm² for the D²PAK) and a very low profile with only 1mm height (vs. 4.4mm for the D²PAK). The significantly smaller package size, combined with benchmark low parasitic inductances, provides designers with a new and effective way to decrease system solution size in power-density driven designs.

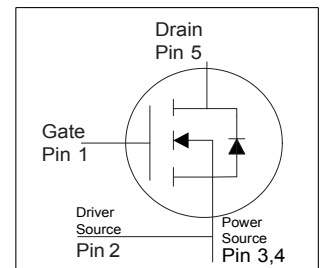
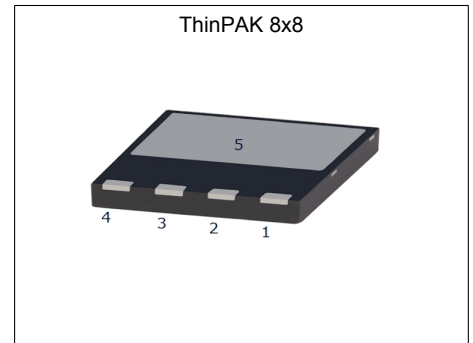

Features

- Ultra-fast body diode
- Very high commutation ruggedness
- Extremely low losses due to very low FOM $R_{ds(on)} \cdot Q_g$ and E_{oss}
- Easy to use/drive
- Qualified for industrial grade applications according to JEDEC (J-STD20 and JESD22)
- Pb-free plating, Halogen free mold compound



Applications

650V CoolMOS™ CFD2 is especially suitable for resonant switching stages for e.g. PC Silverbox, LCD TV, Lighting, Server and Telecom

Table 1 Key Performance Parameters

Parameter	Value	Unit
$V_{DS} @ T_{j,max}$	700	V
$R_{DS(on),max}$	0.725	Ω
Q_g,typ	20	nC
$I_D,pulse$	15.6	A
$E_{oss} @ 400V$	1.9	μJ
Body diode di/dt	900	A/ μs
Q_{rr}	0.2	μC
t_{rr}	65	ns
I_{rrm}	4.5	A

Type / Ordering Code	Package	Marking	Related Links
IPL65R725CFD	PG-VSON-4	65F6725	see Appendix A

Table of Contents

Description	2
Table of Contents	3
Maximum ratings	4
Thermal characteristics	5
Electrical characteristics	6
Electrical characteristics diagrams	8
Test Circuits	12
Package Outlines	13
Appendix A	14
Revision History	15
Disclaimer	15

2 Maximum ratings

at $T_j = 25^\circ\text{C}$, unless otherwise specified

Table 2 Maximum ratings

Parameter	Symbol	Values			Unit	Note / Test Condition
		Min.	Typ.	Max.		
Continuous drain current ¹⁾	I_D			5.8	A	$T_C = 25^\circ\text{C}$
				3.6		$T_C = 100^\circ\text{C}$
Pulsed drain current ²⁾	$I_{D,pulse}$			15.6	A	$T_C = 25^\circ\text{C}$
Avalanche energy, single pulse	E_{AS}			141	mJ	$I_D = 1.2\text{A}$, $V_{DD} = 50\text{V}$ (see table 10)
Avalanche energy, repetitive	E_{AR}			0.21	mJ	$I_D = 1.2\text{A}$, $V_{DD} = 50\text{V}$
Avalanche current, repetitive	I_{AR}			1.2	A	
MOSFET dv/dt ruggedness	dv/dt			50	V/ns	$V_{DS} = 0 \dots 400\text{V}$
Gate source voltage	V_{GS}	-20		20	V	static
		-30		30		AC ($f > 1\text{ Hz}$)
Operating and storage temperature	T_j, T_{stg}	-40		150	$^\circ\text{C}$	
Continuous diode forward current	I_S			5.8	A	$T_C = 25^\circ\text{C}$
Diode pulse current	$I_{S,pulse}$			15.6	A	$T_C = 25^\circ\text{C}$
Reverse diode dv/dt ³⁾	dv/dt			50	V/ns	$V_{DS} = 0 \dots 400\text{V}$, $I_{SD} \leq I_D$, $T_j = 25^\circ\text{C}$ (see table 8)
Maximum diode commutation speed	di/dt			900	A/ μs	
Power dissipation	P_{tot}			62.5	W	$T_C = 25^\circ\text{C}$

¹⁾ Limited by $T_{j,max}$.

²⁾ Pulse width t_p limited by $T_{j,max}$

³⁾ $V_{peak} < V_{(BR)DSS}$, $T_j < T_{j,max}$, identical low side and high side switch with same Rg

3 Thermal characteristics

Table 3 Thermal characteristics ThinPAK 8x8

Parameter	Symbol	Values			Unit	Note / Test Condition
		Min.	Typ.	Max.		
Thermal resistance, junction - case	R_{thJC}			2	°C/W	
Thermal resistance, junction - ambient ¹⁾	R_{thJA}			62	°C/W	SMD version, device on PCB, minimal footprint
				45		SMD version, device on PCB, 6cm ² cooling area
Soldering temperature, wave- & reflowsoldering allowed	T_{sold}			260	°C	reflow MSL 3

¹⁾ Device on 40mm*40mm*1.5mm one layer epoxy PCB FR4 with 6cm² copper area (thickness 70µm) for drain connection. PCB is vertical without air stream cooling.

4 Electrical characteristics

at $T_j = 25^\circ\text{C}$, unless otherwise specified

Table 4 Static characteristics

Parameter	Symbol	Values			Unit	Note / Test Condition
		Min.	Typ.	Max.		
Drain-source breakdown voltage	$V_{(BR)DSS}$	650			V	$V_{GS} = 0V, I_D = 1mA$
Gate threshold voltage	$V_{GS(th)}$	3.5	4	4.5	V	$V_{DS} = V_{GS}, I_D = 0.2mA$
Zero gate voltage drain current	I_{DSS}			1	μA	$V_{DS} = 650V, V_{GS} = 0V, T_j = 25^\circ C$
			100			$V_{DS} = 650V, V_{GS} = 0V, T_j = 150^\circ C$
Gate-source leakage current	I_{GSS}			100	nA	$V_{GS} = 20V, V_{DS} = 0V$
Drain-source on-state resistance	$R_{DS(on)}$		0.653	0.725	Ω	$V_{GS} = 10V, I_D = 2.1A, T_j = 25^\circ C$
			1.698			$V_{GS} = 10V, I_D = 2.1A, T_j = 150^\circ C$
Gate resistance	R_G		6.5		Ω	$f = 1MHz, \text{open drain}$

Table 5 Dynamic characteristics

Parameter	Symbol	Values			Unit	Note / Test Condition
		Min.	Typ.	Max.		
Input capacitance	C_{iss}		615		pF	$V_{GS} = 0V, V_{DS} = 100V, f = 1MHz$
Output capacitance	C_{oss}		33			
Effective output capacitance, energy related ¹⁾	$C_{o(er)}$		21		pF	$V_{GS} = 0V, V_{DS} = 0 \dots 400V$
Effective output capacitance, time related ²⁾	$C_{o(tr)}$		88		pF	$I_D = \text{constant}, V_{GS} = 0V, V_{DS} = 0 \dots 400V$
Turn-on delay time	$t_{d(on)}$		9		ns	$V_{DD} = 400V, V_{GS} = 13V, I_D = 3.2A, R_G = 6.8\Omega$ (see table 9)
Rise time	t_r		8			
Turn-off delay time	$t_{d(off)}$		40			
Fall time	t_f		10			

Table 6 Gate charge characteristics

Parameter	Symbol	Values			Unit	Note / Test Condition
		Min.	Typ.	Max.		
Gate to source charge	Q_{gs}		3.5		nC	$V_{DD} = 480V, I_D = 3.2A, V_{GS} = 0 \text{ to } 10V$
Gate to drain charge	Q_{gd}		12			
Gate charge total	Q_g		20			
Gate plateau voltage	$V_{plateau}$		6.4			

¹⁾ $C_{o(er)}$ is a fixed capacitance that gives the same stored energy as C_{oss} while V_{DS} is rising from 0 to 400V

²⁾ $C_{o(tr)}$ is a fixed capacitance that gives the same charging time as C_{oss} while V_{DS} is rising from 0 to 400V

Table 7 Reverse diode characteristics

Parameter	Symbol	Values			Unit	Note / Test Condition
		Min.	Typ.	Max.		
Diode forward voltage	V_{SD}		0.9		V	$V_{GS} = 0V, I_F = 3.2A, T_j = 25^\circ C$
Reverse recovery time	t_{rr}		65		ns	$V_R = 400V, I_F = 3.2A,$ $di_F/dt = 100A/\mu s$ (see table 8)
Reverse recovery charge	Q_{rr}		0.2		μC	
Peak reverse recovery current	I_{rrm}		4.5		A	

5 Electrical characteristics diagrams

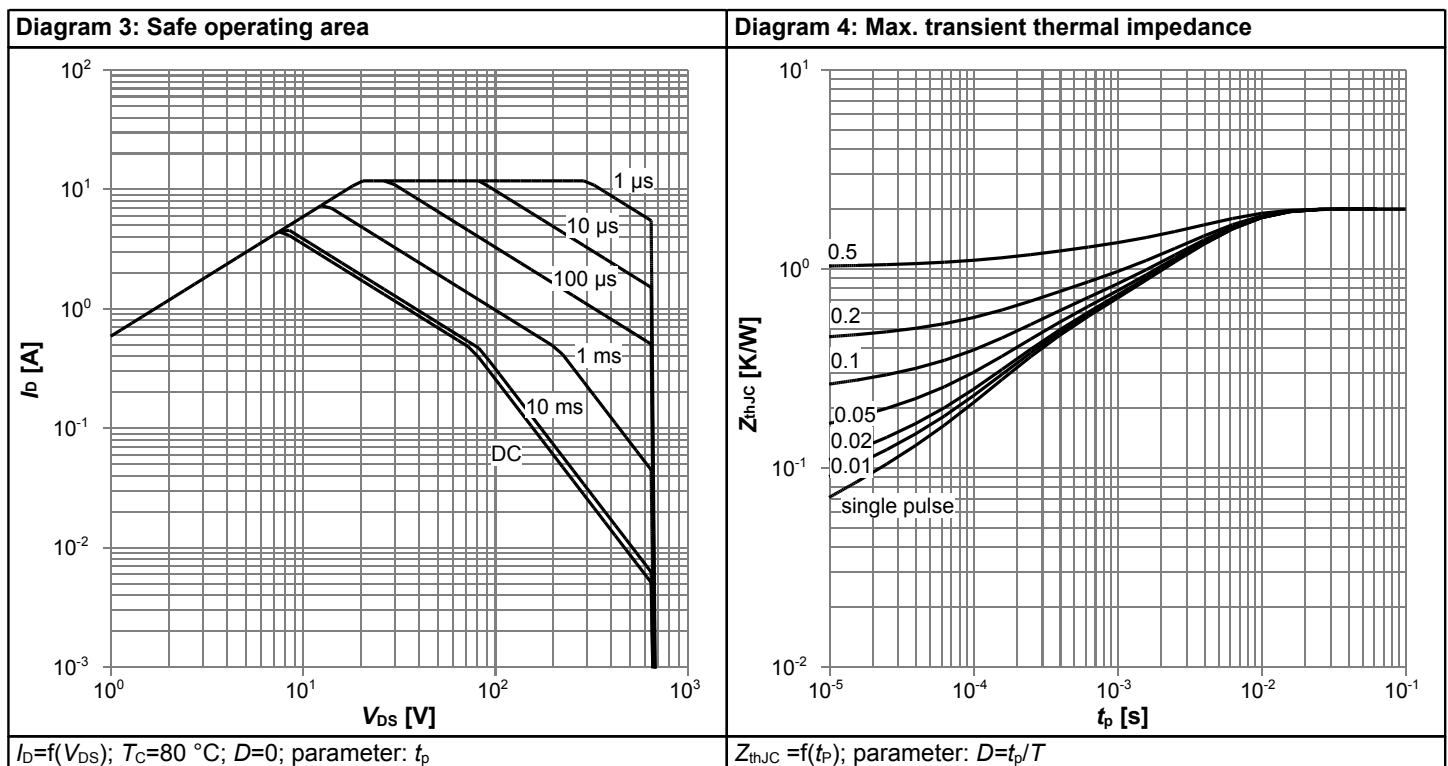
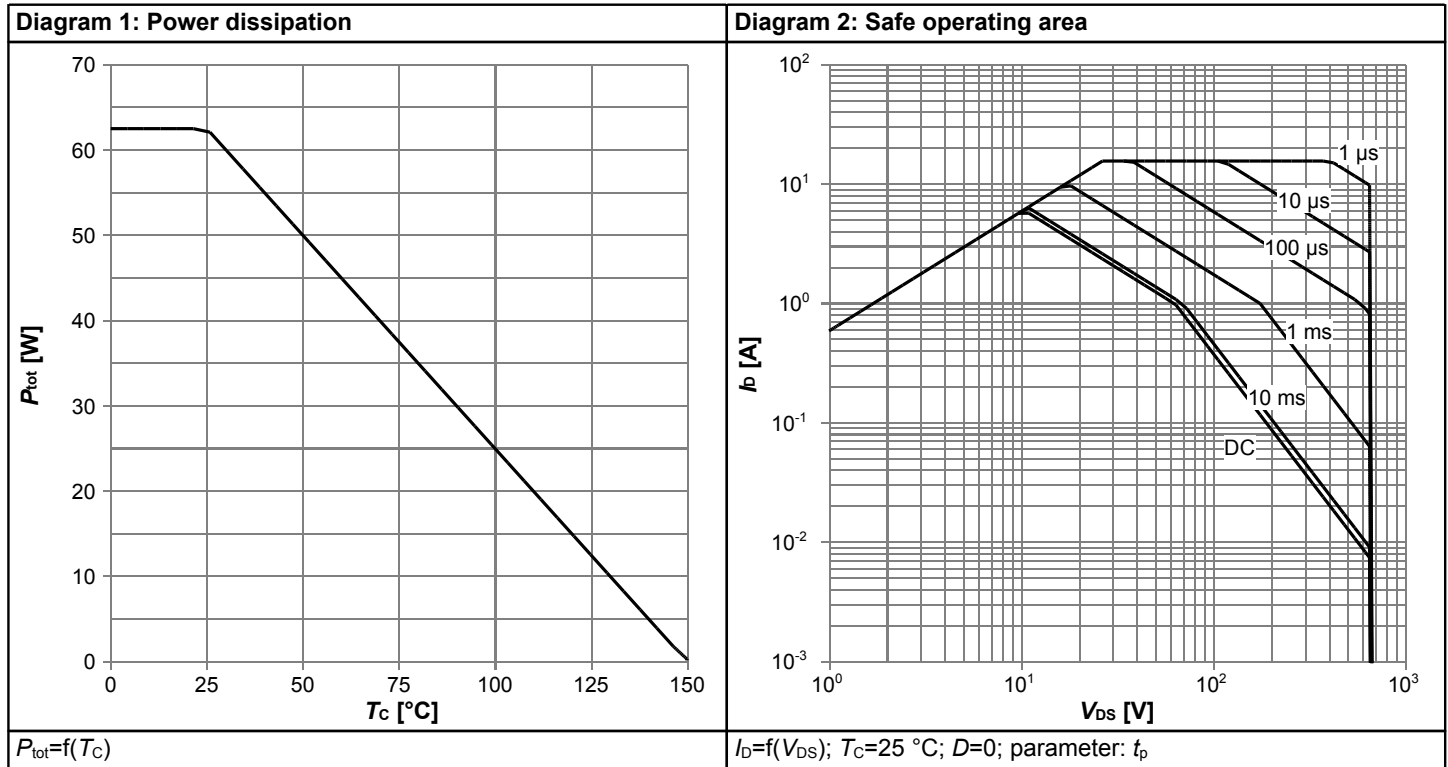
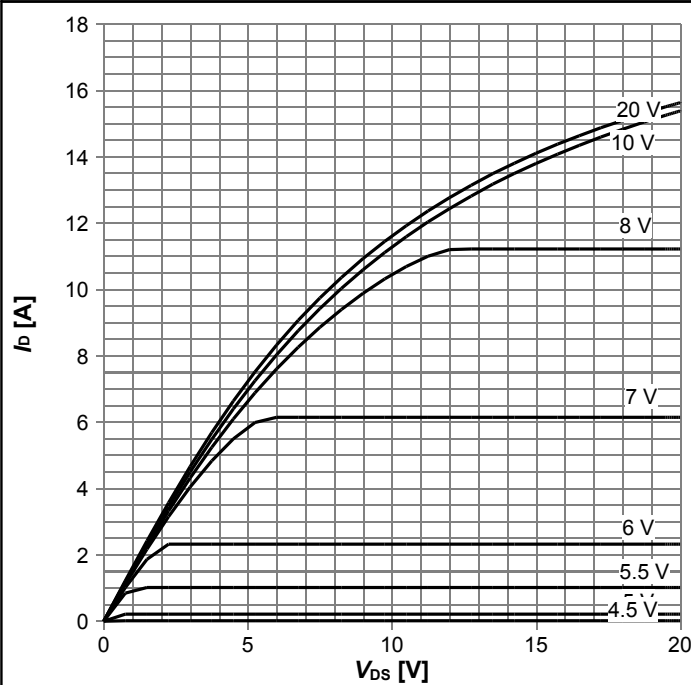
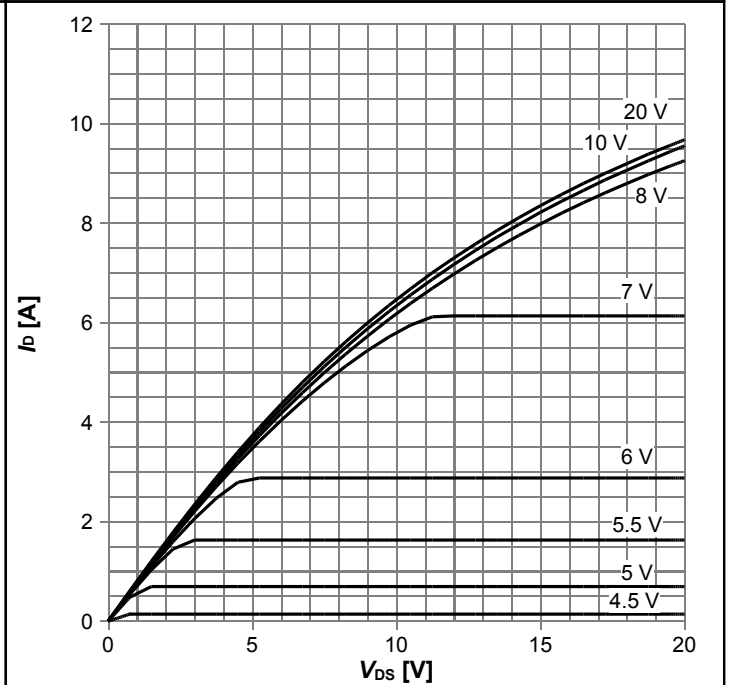

Diagram 5: Typ. output characteristics



$I_D=f(V_{DS}); T_j=25\text{ °C};$ parameter: V_{GS}

Diagram 6: Typ. output characteristics



$I_D=f(V_{DS}); T_j=125\text{ °C};$ parameter: V_{GS}

Diagram 7: Typ. drain-source on-state resistance

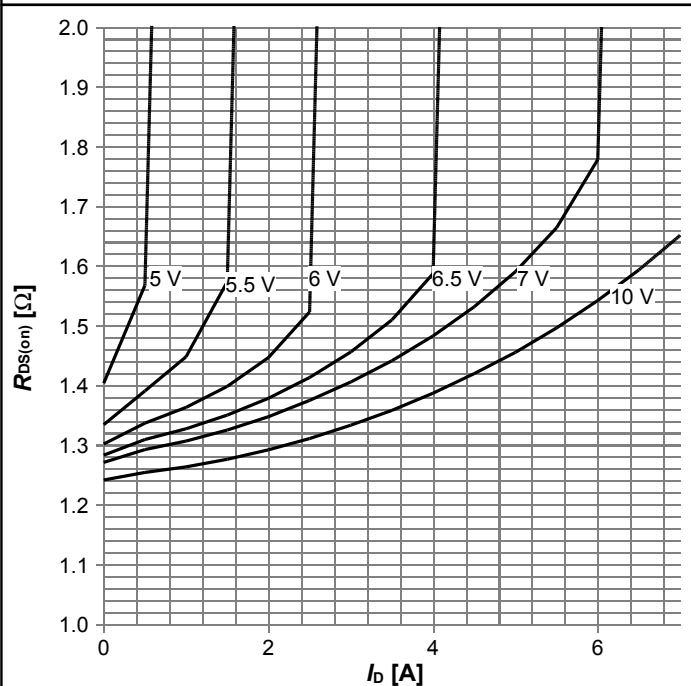

$R_{DS(on)}=f(I_D); T_j=125\text{ °C};$ parameter: V_{GS}

Diagram 8: Drain-source on-state resistance

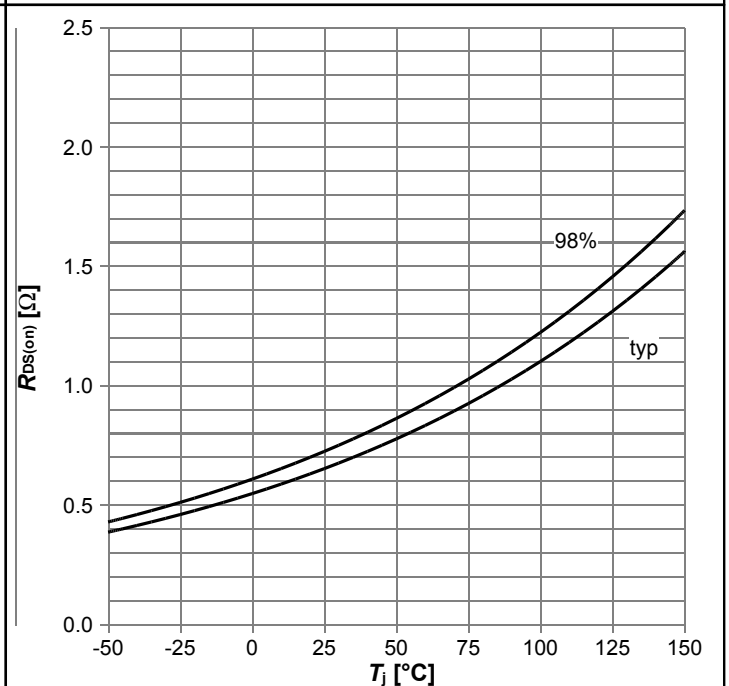

$R_{DS(on)}=f(T_j); I_D=2.1\text{ A}; V_{GS}=10\text{ V}$

Diagram 9: Typ. transfer characteristics

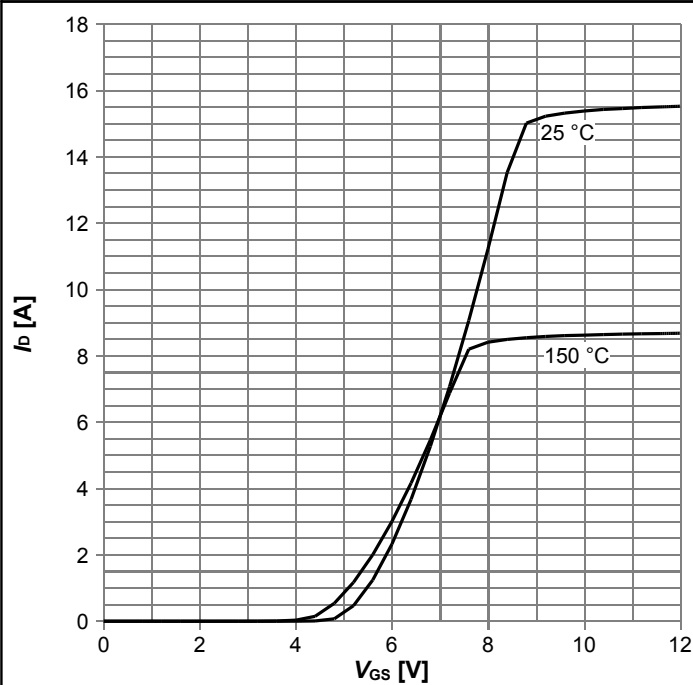

$I_D=f(V_{GS}); V_{DS}=20V; \text{parameter: } T_j$

Diagram 10: Typ. gate charge

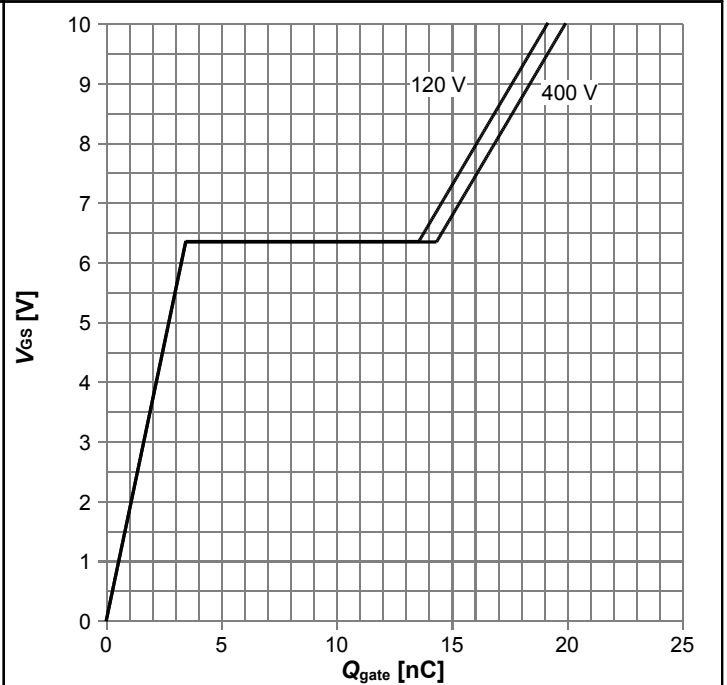

$V_{GS}=f(Q_{gate}); I_D=3.2 \text{ A pulsed}; \text{parameter: } V_{DD}$

Diagram 11: Forward characteristics of reverse diode

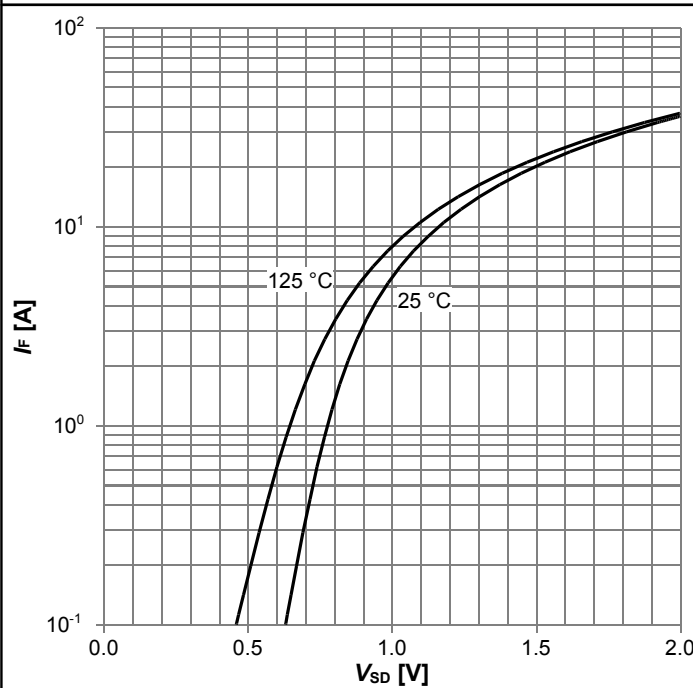

$I_F=f(V_{SD}); \text{parameter: } T_j$

Diagram 12: Avalanche energy

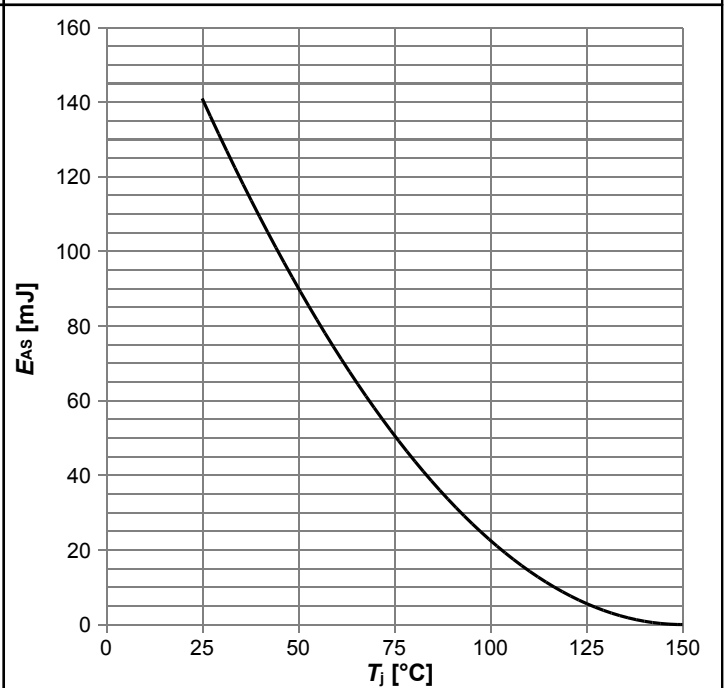

$E_{AS}=f(T_j); I_D=1.2 \text{ A}; V_{DD}=50 \text{ V}$

Diagram 13: Drain-source breakdown voltage

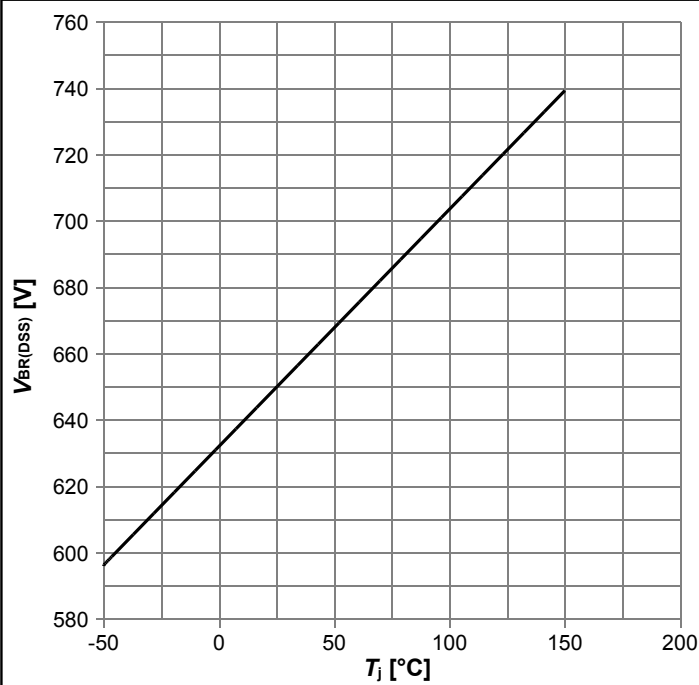

$V_{BR(DSS)}=f(T_j); I_D=1 \text{ mA}$

Diagram 14: Typ. capacitances

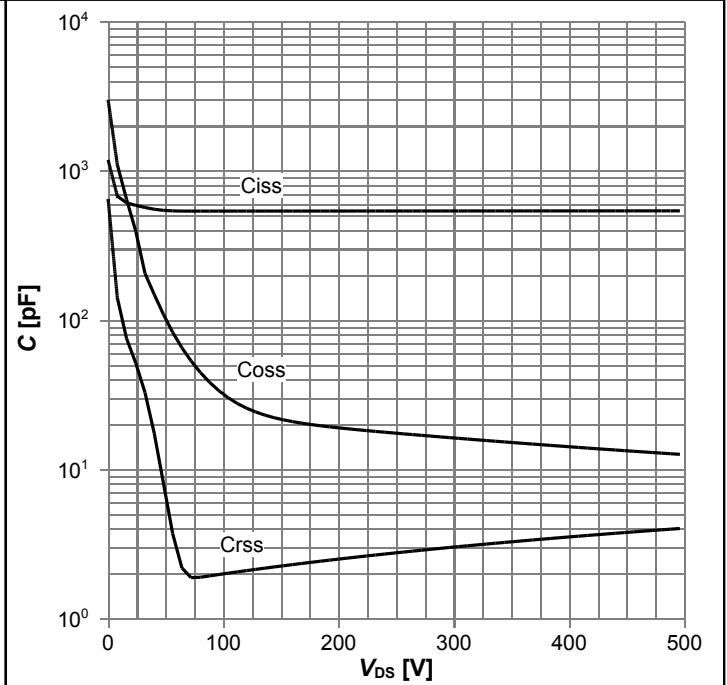

$C=f(V_{DS}); V_{GS}=0 \text{ V}; f=1\text{MHz}$

Diagram 15: Typ. Coss stored energy

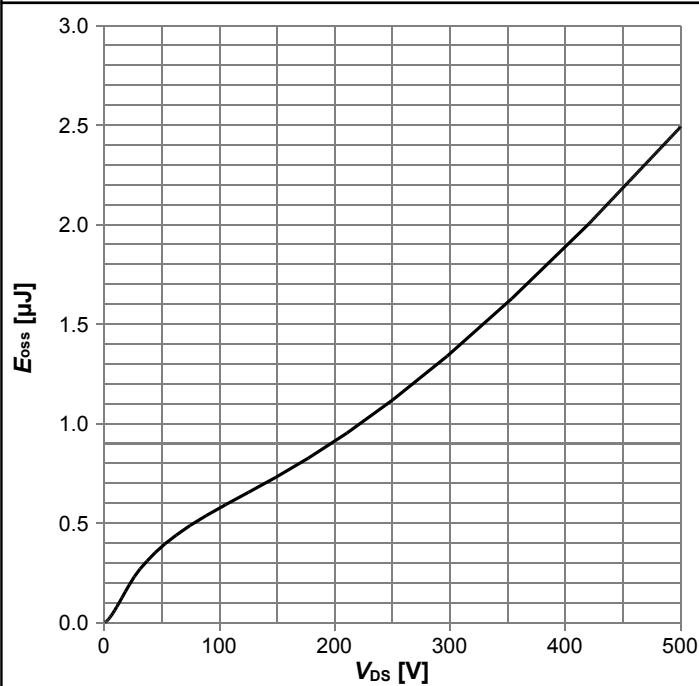

$E_{oss}=f(V_{DS})$

6 Test Circuits

Table 8 Diode characteristics

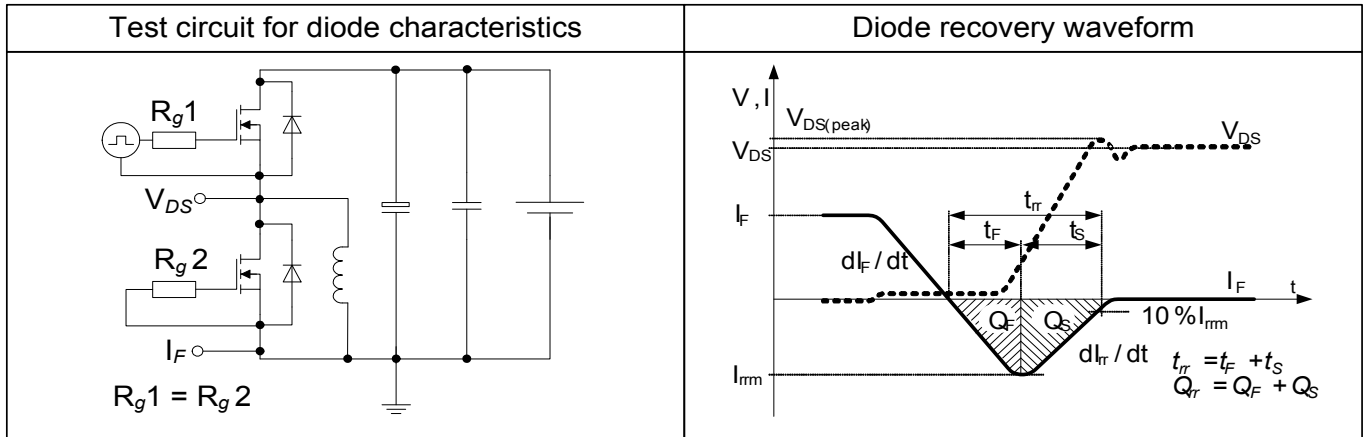

Table 9 Switching times

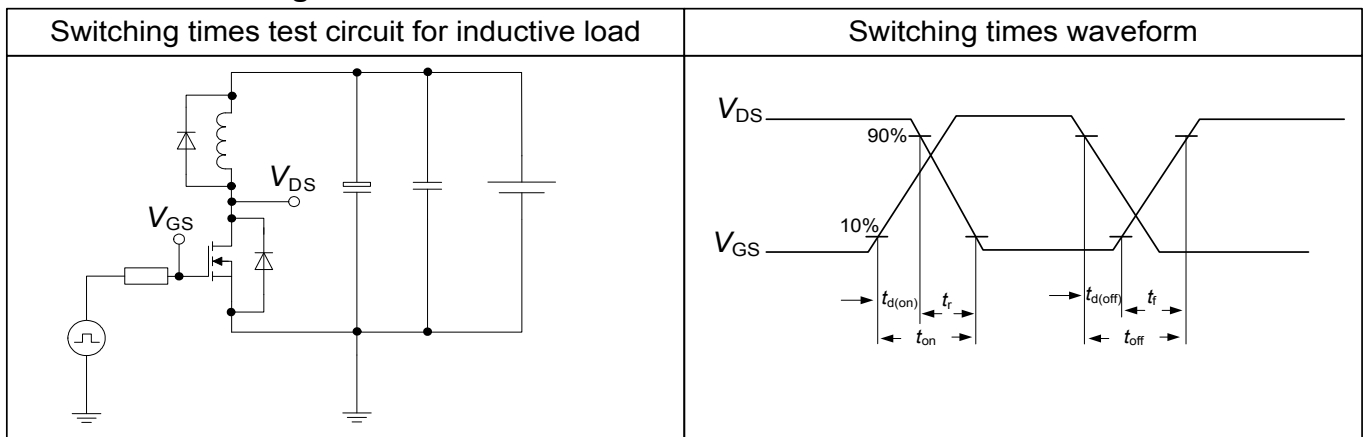
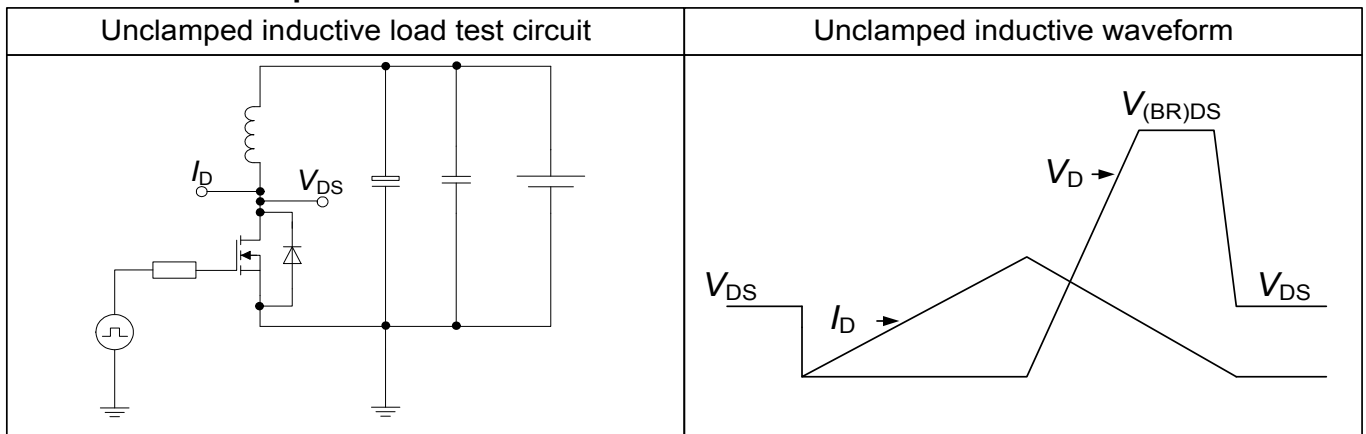
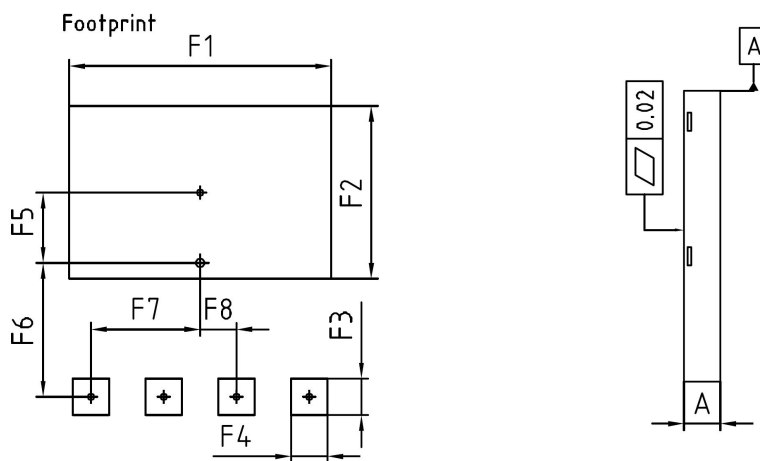

Table 10 Unclamped inductive load



7 Package Outlines



DIM	MILLIMETERS		INCHES	
	MIN	MAX	MIN	MAX
A	0.90	1.10	0.035	0.043
b	0.90	1.10	0.035	0.043
b1	0.00	0.05	0.000	0.002
c	0.10	0.30	0.004	0.012
D	7.90	8.10	0.311	0.319
D1	7.10	7.30	0.280	0.287
E	7.90	8.10	0.311	0.319
E1	4.65	4.85	0.183	0.191
E2	2.65	2.85	0.104	0.112
E3	0.30	0.50	0.012	0.020
e	2.00 (BSC)		0.079 (BSC)	
L	0.40	0.60	0.016	0.024
N	4		4	
F1	7.20		0.283	
F2	4.75		0.187	
F3	1.00		0.039	
F4	1.00		0.039	
F5	1.43		0.056	
F6	4.20		0.165	
F7	3.00		0.118	
F8	1.00		0.039	

DOCUMENT NO.
Z8B00156707

SCALE

EUROPEAN PROJECTION

ISSUE DATE
05-04-2010

REVISION
01

Figure 1 Outline PG-VSON-4, dimensions in mm/inches

8 Appendix A

Table 11 Related Links

- IFX Design Tools: www.infineon.com
- IFX CoolMOS Webpage: www.infineon.com

Revision History

IPL65R725CFD

Revision: 2013-05-28, Rev. 2.0

Previous Revision

Revision	Date	Subjects (major changes since last revision)
2.0	2013-05-28	Release of final version

We Listen to Your Comments

Any information within this document that you feel is wrong, unclear or missing at all? Your feedback will help us to continuously improve the quality of this document. Please send your proposal (including a reference to this document) to:

erratum@infineon.com

Edition 2011-08-01

Published by

Infineon Technologies AG

81726 München, Germany

© 2011 Infineon Technologies AG

All Rights Reserved.

Legal Disclaimer

The information given in this document shall in no event be regarded as a guarantee of conditions or characteristics. With respect to any examples or hints given herein, any typical values stated herein and/or any information regarding the application of the device, Infineon Technologies hereby disclaims any and all warranties and liabilities of any kind, including without limitation, warranties of non-infringement of intellectual property rights of any third party.

Information

For further information on technology, delivery terms and conditions and prices please contact your nearest Infineon Technologies Office (www.infineon.com).

Warnings

Due to technical requirements, components may contain dangerous substances. For information on the types in question, please contact the nearest Infineon Technologies Office.

The Infineon Technologies component described in this Data Sheet may be used in life-support devices or systems and/or automotive, aviation and aerospace applications or systems only with the express written approval of Infineon Technologies, if a failure of such components can reasonably be expected to cause the failure of that life-support, automotive, aviation and aerospace device or system or to affect the safety or effectiveness of that device or system. Life support devices or systems are intended to be implanted in the human body or to support and/or maintain and sustain and/or protect human life. If they fail, it is reasonable to assume that the health of the user or other persons may be endangered.