

isc N-Channel MOSFET Transistor
IPW50R350CP
IIPW50R350CP
• FEATURES

- Static drain-source on-resistance:
 $R_{ds(on)} \leq 350m\Omega$
- Enhancement mode:
- 100% avalanche tested
- Minimum Lot-to-Lot variations for robust device performance and reliable operation

• DESCRIPTION

- High Peak Current Capability

• ABSOLUTE MAXIMUM RATINGS($T_a=25^\circ\text{C}$)

SYMBOL	PARAMETER	VALUE	UNIT
V_{DSS}	Drain-Source Voltage	500	V
V_{GS}	Gate-Source Voltage	± 20	V
I_D	Drain Current-Continuous	10	A
I_{DM}	Drain Current-Single Pulsed	22	A
P_D	Total Dissipation @ $T_c=25^\circ\text{C}$	89	W
T_j	Max. Operating Junction Temperature	150	$^\circ\text{C}$
T_{stg}	Storage Temperature	-55~150	$^\circ\text{C}$

• THERMAL CHARACTERISTICS

SYMBOL	PARAMETER	MAX	UNIT
$R_{th(j-c)}$	Channel-to-case thermal resistance	1.4	$^\circ\text{C/W}$
$R_{th(j-a)}$	Channel-to-ambient thermal resistance	62	$^\circ\text{C/W}$

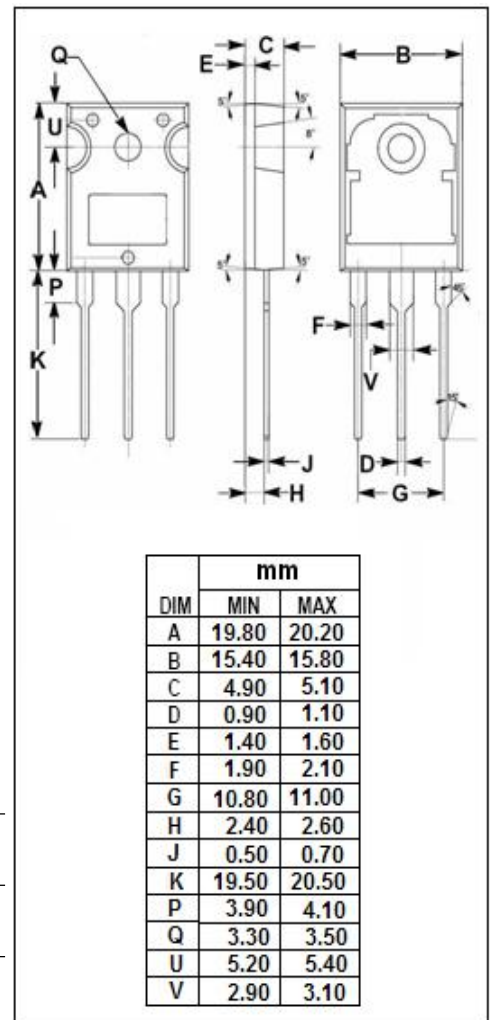
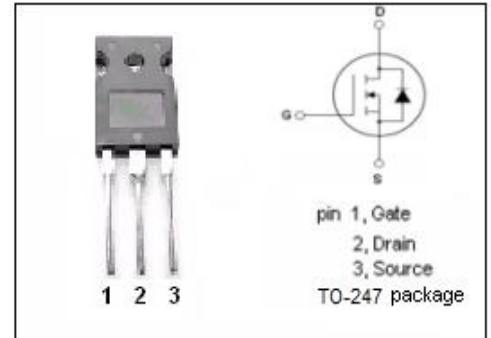

isc N-Channel MOSFET Transistor**IPW50R350CP****IIPW50R350CP****ELECTRICAL CHARACTERISTICS** $T_c=25^{\circ}\text{C}$ unless otherwise specified

SYMBOL	PARAMETER	CONDITIONS	MIN	TYP	MAX	UNIT
BV_{DSS}	Drain-Source Breakdown Voltage	$V_{GS}=0V; I_D=250\ \mu\text{A}$	500			V
$V_{GS(th)}$	Gate Threshold Voltage	$V_{DS}=V_{GS}; I_D=440\ \mu\text{A}$	2.5		3.5	V
$R_{DS(on)}$	Drain-Source On-Resistance	$V_{GS}=10V; I_D=5.6A$			0.35	Ω
I_{GSS}	Gate-Source Leakage Current	$V_{GS}=20V; V_{DS}=0V$			0.1	μA
I_{DSS}	Drain-Source Leakage Current	$V_{DS}=500V; V_{GS}=0V$			1	μA
V_{SD}	Diode forward voltage	$I_F=5.6A, V_{GS}=0V$			1.2	V

NOTICE:

ISC reserves the rights to make changes of the content herein the datasheet at any time without notification. The information contained herein is presented only as a guide for the applications of our products.

ISC products are intended for usage in general electronic equipment. The products are not designed for use in equipment which require specialized quality and/or reliability, or in equipment which could have applications in hazardous environments, aerospace industry, or medical field. Please contact us if you intend our products to be used in these special applications.

ISC makes no warranty or guarantee regarding the suitability of its products for any particular purpose, nor does ISC assume any liability arising from the application or use of any products, and specifically disclaims any and all liability, including without limitation special, consequential or incidental damages.