

# MOSFET

Metal Oxide Semiconductor Field Effect Transistor

## CoolMOS™ C6

600V CoolMOS™ C6 Power Transistor  
IPx60R099C6

## Data Sheet

Rev. 2.3  
Final

## 600V CoolMOS™ C6 Power Transistor

IPA60R099C6, IPB60R099C6  
IPP60R099C6 IPW60R099C6

### 1 Description

CoolMOS™ is a revolutionary technology for high voltage power MOSFETs, designed according to the superjunction (SJ) principle and pioneered by Infineon Technologies. CoolMOS™ C6 series combines the experience of the leading SJ MOSFET supplier with high class innovation. The offered devices provide all benefits of a fast switching SJ MOSFET while not sacrificing ease of use. Extremely low switching and conduction losses make switching applications even more efficient, more compact, lighter, and cooler.

#### Features

- Extremely low losses due to very low FOM  $R_{DS(on)} \cdot Q_g$  and  $E_{oss}$
- Very high commutation ruggedness
- Easy to use/drive
- JEDEC<sup>1)</sup> qualified, Pb-free plating, Halogen free

#### Applications

PFC stages, hard switching PWM stages and resonant switching PWM stages for e.g. PC Silverbox, Adapter, LCD & PDP TV, Lighting, Server, Telecom and UPS.

Please note: For MOSFET paralleling the use of ferrite beads on the gate or separate totem poles is generally recommended.

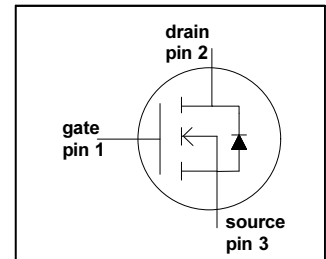
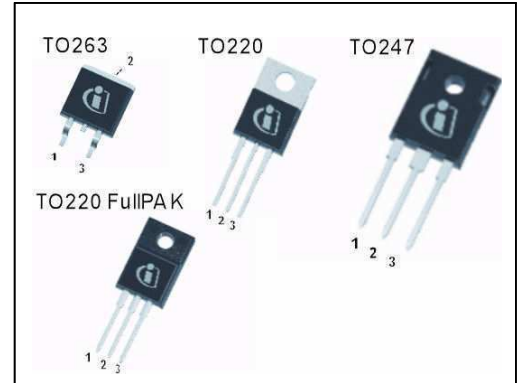

**Table 1 Key Performance Parameters**

Parameter	Value	Unit
$V_{DS} @ T_{j,max}$	650	V
$R_{DS(on),max}$	0.099	$\Omega$
$Q_{g,typ}$	119	nC
$I_{D,pulse}$	112	A
$E_{oss} @ 400V$	9.3	$\mu J$
Body diode $di/dt$	300	A/ $\mu s$

Type / Ordering Code	Package	Marking	Related Links
IPW60R099C6	PG-TO247	6R099C6	<a href="#">IFX C6 Product Brief</a> <a href="#">IFX C6 Portfolio</a> <a href="#">IFX CoolMOS Webpage</a> <a href="#">IFX Design tools</a>
IPB60R099C6	PG-TO263		
IPP60R099C6	PG-TO220		
IPA60R099C6	PG-TO220 FullPAK		

1) J-STD20 and JESD22

## Table of Contents

1	Description .....	2
	Table of Contents .....	3
2	Maximum ratings .....	4
3	Thermal characteristics .....	5
4	Electrical characteristics .....	6
5	Electrical characteristics diagrams .....	8
6	Test circuits .....	13
7	Package outlines .....	14
8	Revision History .....	18

## 2 Maximum ratings

at  $T_j = 25\text{ °C}$ , unless otherwise specified.

**Table 2 Maximum ratings**

Parameter	Symbol	Values			Unit	Note / Test Condition
		Min.	Typ.	Max.		
Continuous drain current <sup>1)</sup>	$I_D$	-	-	37.9	A	$T_C = 25\text{ °C}$
				24		$T_C = 100\text{ °C}$
Pulsed drain current <sup>2)</sup>	$I_{D,pulse}$	-	-	112	A	$T_C = 25\text{ °C}$
Avalanche energy, single pulse	$E_{AS}$	-	-	796	mJ	$I_D = 6.6\text{ A}, V_{DD} = 50\text{ V}$ (see table 21)
Avalanche energy, repetitive	$E_{AR}$	-	-	1.2		$I_D = 6.6\text{ A}, V_{DD} = 50\text{ V}$
Avalanche current, repetitive	$I_{AR}$	-	-	6.6	A	
MOSFET dv/dt ruggedness	dv/dt	-	-	50	V/ns	$V_{DS} = 0 \dots 480\text{ V}$
Gate source voltage	$V_{GS}$	-20	-	20	V	static
		-30		30		AC ( $f > 1\text{ Hz}$ )
Power dissipation for TO-220, TO-247, TO-263	$P_{tot}$	-	-	278	W	$T_C = 25\text{ °C}$
Power dissipation for TO-220 FullPAK	$P_{tot}$	-	-	35		
Operating and storage temperature	$T_j, T_{stg}$	-55	-	150	°C	
Mounting torque TO-220, TO-247		-	-	60	Ncm	M3 and M3.5 screws
Mounting torque TO-220 FullPAK				50		M2.5 screws
Continuous diode forward current	$I_S$	-	-	33	A	$T_C = 25\text{ °C}$
Diode pulse current <sup>2)</sup>	$I_{S,pulse}$	-	-	112	A	$T_C = 25\text{ °C}$
Reverse diode dv/dt <sup>3)</sup>	dv/dt	-	-	15	V/ns	$V_{DS} = 0 \dots 400\text{ V}, I_{SD} \leq I_D,$ $T_j = 25\text{ °C}$
Maximum diode commutation speed <sup>3)</sup>	di/dt			300	A/ $\mu$ s	(see table 22)

1) Limited by  $T_{j,max}$ . Maximum duty cycle  $D = 0.75$

2) Pulse width  $t_p$  limited by  $T_{j,max}$

3) Identical low side and high side switch with identical  $R_G$

### 3 Thermal characteristics

**Table 3 Thermal characteristics TO-220 (IPP60R099C6), TO-247 (IPW60R099C6)**

Parameter	Symbol	Values			Unit	Note / Test Condition
		Min.	Typ.	Max.		
Thermal resistance, junction - case	$R_{thJC}$	-	-	0.45	°C/W	leaded
Thermal resistance, junction - ambient	$R_{thJA}$	-	-	62		
Soldering temperature, wavesoldering only allowed at leads	$T_{sold}$	-	-	260	°C	1.6 mm (0.063 in.) from case for 10 s

**Table 4 Thermal characteristics TO-220FullIPAK (IPA60R099C6)**

Parameter	Symbol	Values			Unit	Note / Test Condition
		Min.	Typ.	Max.		
Thermal resistance, junction - case	$R_{thJC}$	-	-	3.6	°C/W	leaded
Thermal resistance, junction - ambient	$R_{thJA}$	-	-	80		
Soldering temperature, wavesoldering only allowed at leads	$T_{sold}$	-	-	260	°C	1.6 mm (0.063 in.) from case for 10 s

**Table 5 Thermal characteristics TO-263 (IPB60R099C6)**

Parameter	Symbol	Values			Unit	Note / Test Condition
		Min.	Typ.	Max.		
Thermal resistance, junction - case	$R_{thJC}$	-	-	0.45	°C/W	SMD version, device on PCB, minimal footprint
Thermal resistance, junction - ambient	$R_{thJA}$	-	-	62		
		-	35	-		
Soldering temperature, wave- & reflow soldering allowed	$T_{sold}$	-	-	260	°C	reflow MSL1

1) Device on 40mm\*40mm\*1.5mm one layer epoxy PCB FR4 with 6cm<sup>2</sup> copper area (thickness 70µm) for drain connection. PCB is vertical without air stream cooling.

## 4 Electrical characteristics

Electrical characteristics, at  $T_J=25\text{ °C}$ , unless otherwise specified.

**Table 6 Static characteristics**

Parameter	Symbol	Values			Unit	Note / Test Condition
		Min.	Typ.	Max.		
Drain-source breakdown voltage	$V_{(BR)DSS}$	600	-	-	V	$V_{GS}=0\text{ V}$ , $I_D=0.25\text{ mA}$
Gate threshold voltage	$V_{GS(th)}$	2.5	3	3.5		$V_{DS}=V_{GS}$ , $I_D=1.21\text{ mA}$
Zero gate voltage drain current	$I_{DSS}$	-	-	5	$\mu\text{A}$	$V_{DS}=600\text{ V}$ , $V_{GS}=0\text{ V}$ , $T_J=25\text{ °C}$
		-	50	-		$V_{DS}=600\text{ V}$ , $V_{GS}=0\text{ V}$ , $T_J=150\text{ °C}$
Gate-source leakage current	$I_{GSS}$	-	-	100	nA	$V_{GS}=20\text{ V}$ , $V_{DS}=0\text{ V}$
Drain-source on-state resistance	$R_{DS(on)}$	-	0.09	0.099	$\Omega$	$V_{GS}=10\text{ V}$ , $I_D=18.1\text{ A}$ , $T_J=25\text{ °C}$
		-	0.23	-		$V_{GS}=10\text{ V}$ , $I_D=18.1\text{ A}$ , $T_J=150\text{ °C}$
Gate resistance	$R_G$	-	1.6	-	$\Omega$	$f=1\text{ MHz}$ , open drain

**Table 7 Dynamic characteristics**

Parameter	Symbol	Values			Unit	Note / Test Condition
		Min.	Typ.	Max.		
Input capacitance	$C_{iss}$	-	2660	-	pF	$V_{GS}=0\text{ V}$ , $V_{DS}=100\text{ V}$ , $f=1\text{ MHz}$
Output capacitance	$C_{oss}$	-	154	-		
Effective output capacitance, energy related <sup>1)</sup>	$C_{o(er)}$	-	100	-		
Effective output capacitance, time related <sup>2)</sup>	$C_{o(tr)}$	-	500	-		$I_D=\text{constant}$ , $V_{GS}=0\text{ V}$ $V_{DS}=0\dots480\text{ V}$
Turn-on delay time	$t_{d(on)}$	-	15	-	ns	$V_{DD}=400\text{ V}$ , $V_{GS}=13\text{ V}$ , $I_D=18.1\text{ A}$ , $R_G=1.7\Omega$ (see table 20)
Rise time	$t_r$	-	12	-		
Turn-off delay time	$t_{d(off)}$	-	75	-		
Fall time	$t_f$	-	6	-		

1)  $C_{o(er)}$  is a fixed capacitance that gives the same stored energy as  $C_{oss}$  while  $V_{DS}$  is rising from 0 to 80%  $V_{(BR)DSS}$

2)  $C_{o(tr)}$  is a fixed capacitance that gives the same charging time as  $C_{oss}$  while  $V_{DS}$  is rising from 0 to 80%  $V_{(BR)DSS}$

**Table 8 Gate charge characteristics**

Parameter	Symbol	Values			Unit	Note / Test Condition
		Min.	Typ.	Max.		
Gate to source charge	$Q_{gs}$	-	14	-	nC	$V_{DD}=480\text{ V}$ , $I_D=18.1\text{ A}$ , $V_{GS}=0\text{ to }10\text{ V}$
Gate to drain charge	$Q_{gd}$	-	61	-		
Gate charge total	$Q_g$	-	119	-		
Gate plateau voltage	$V_{plateau}$	-	5.4	-	V	

**Table 9 Reverse diode characteristics**

Parameter	Symbol	Values			Unit	Note / Test Condition
		Min.	Typ.	Max.		
Diode forward voltage	$V_{SD}$	-	0.9	-	V	$V_{GS}=0\text{ V}$ , $I_F=18.1\text{ A}$ , $T_j=25\text{ °C}$
Reverse recovery time	$t_{rr}$	-	580	-	ns	$V_R=400\text{ V}$ , $I_F=18.1\text{ A}$ , $di_F/dt=100\text{ A}/\mu\text{s}$ (see table 22)
Reverse recovery charge	$Q_{rr}$	-	13	-	$\mu\text{C}$	
Peak reverse recovery current	$I_{rrm}$	-	43	-	A	

5 Electrical characteristics diagrams

Table 10

Power dissipation TO-220, TO-247, TO-263	Power dissipation TO-220 FullPAK
$P_{tot} = f(T_C)$	$P_{tot} = f(T_C)$

Table 11

Max. transient thermal impedance TO-220, TO-247, TO-263	Max. transient thermal impedance TO-220 FullPAK
$Z_{(thJC)} = f(t_p)$ ; parameter: $D = t_p / T$	$Z_{(thJC)} = f(t_p)$ ; parameter: $D = t_p / T$



Table 12

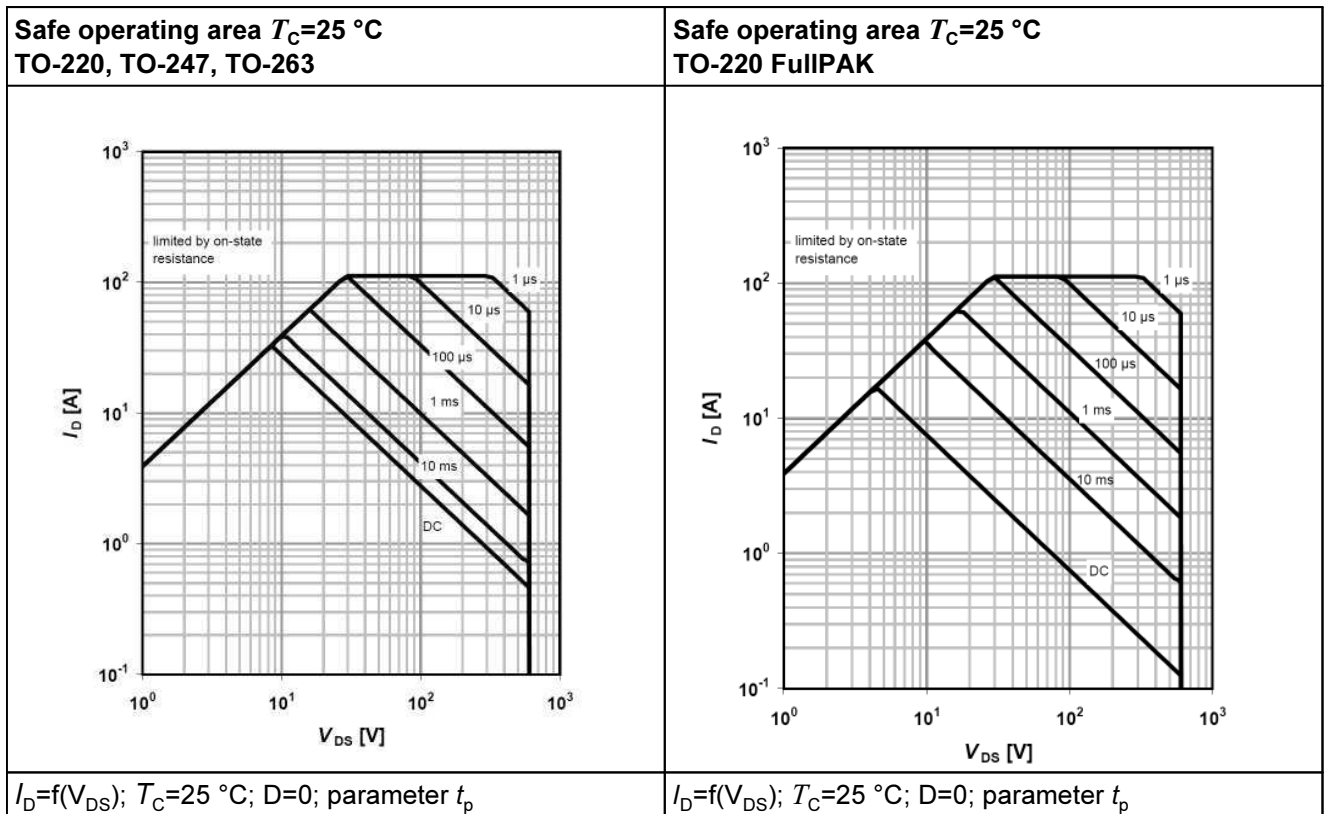

Table 13

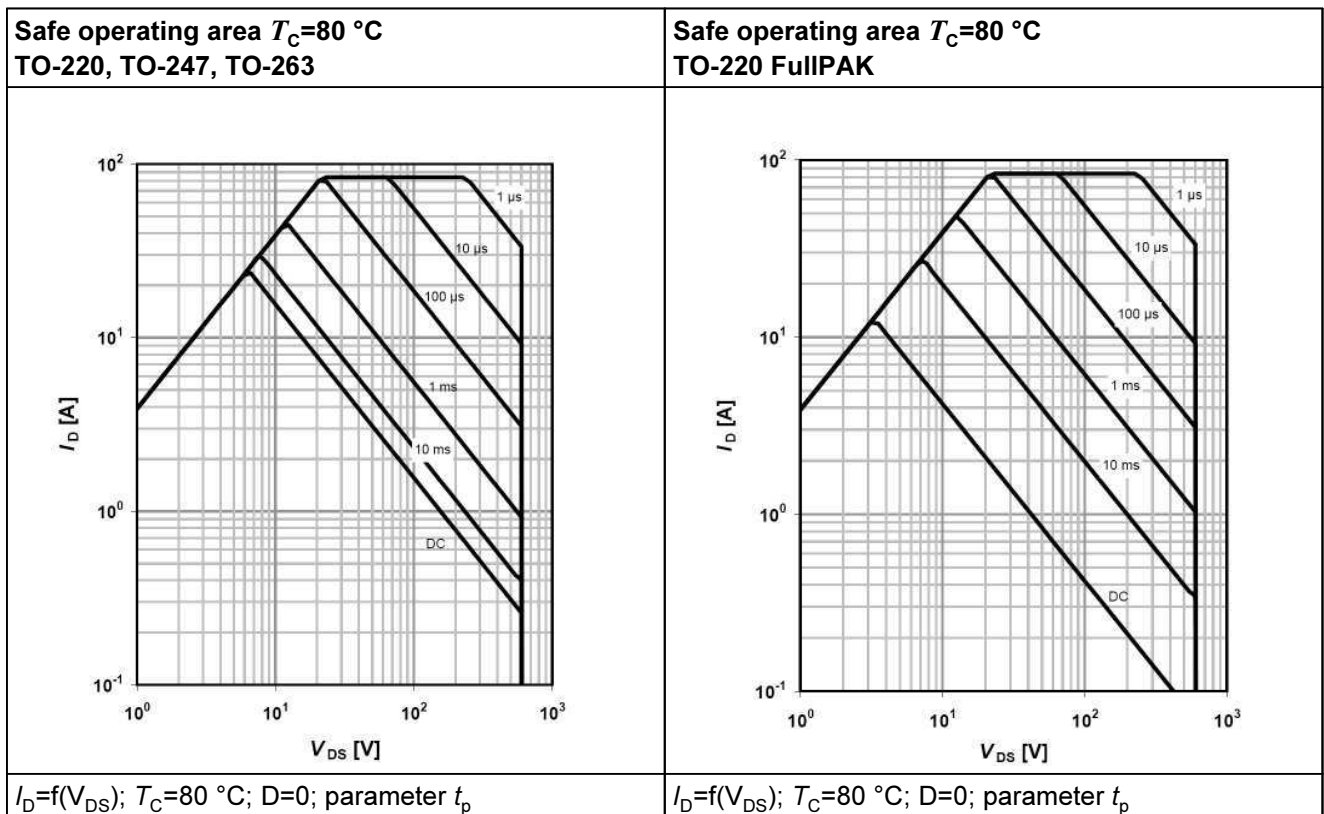

Table 14

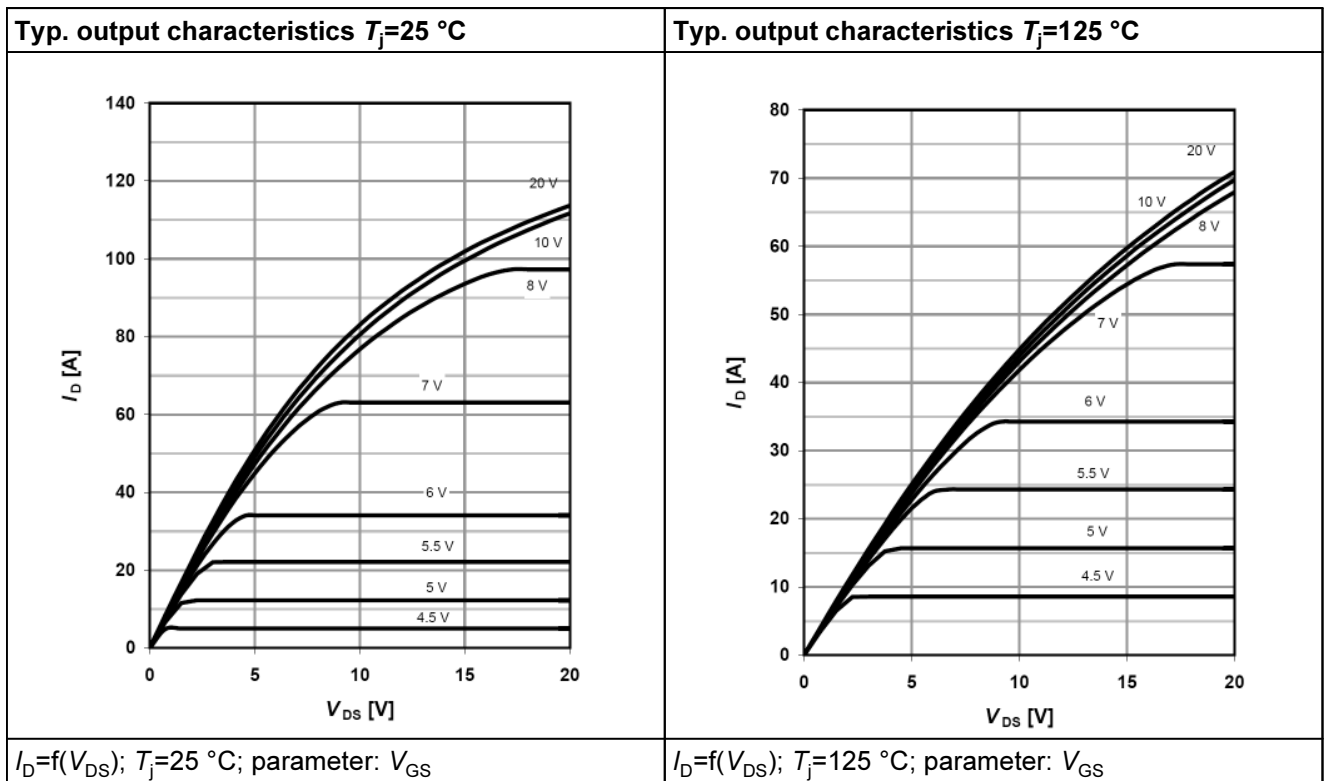

Table 15

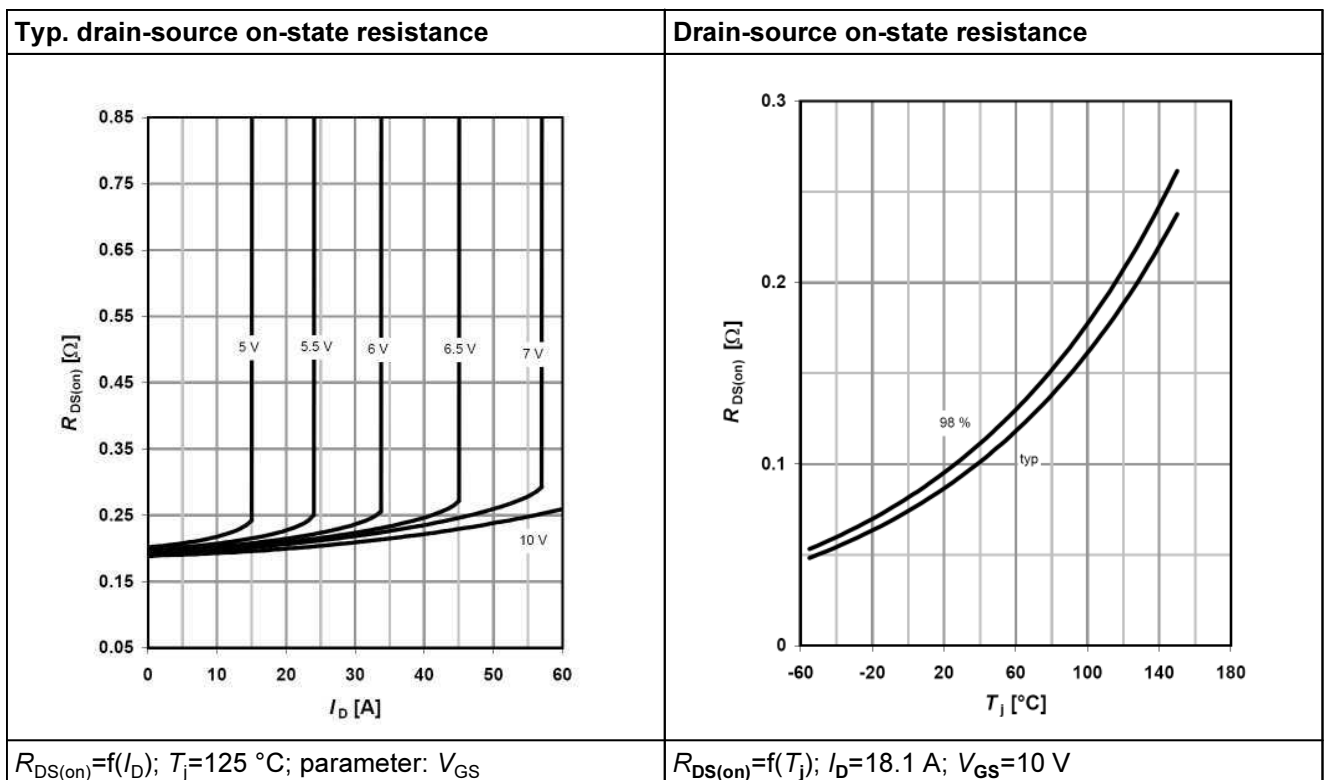

Table 16

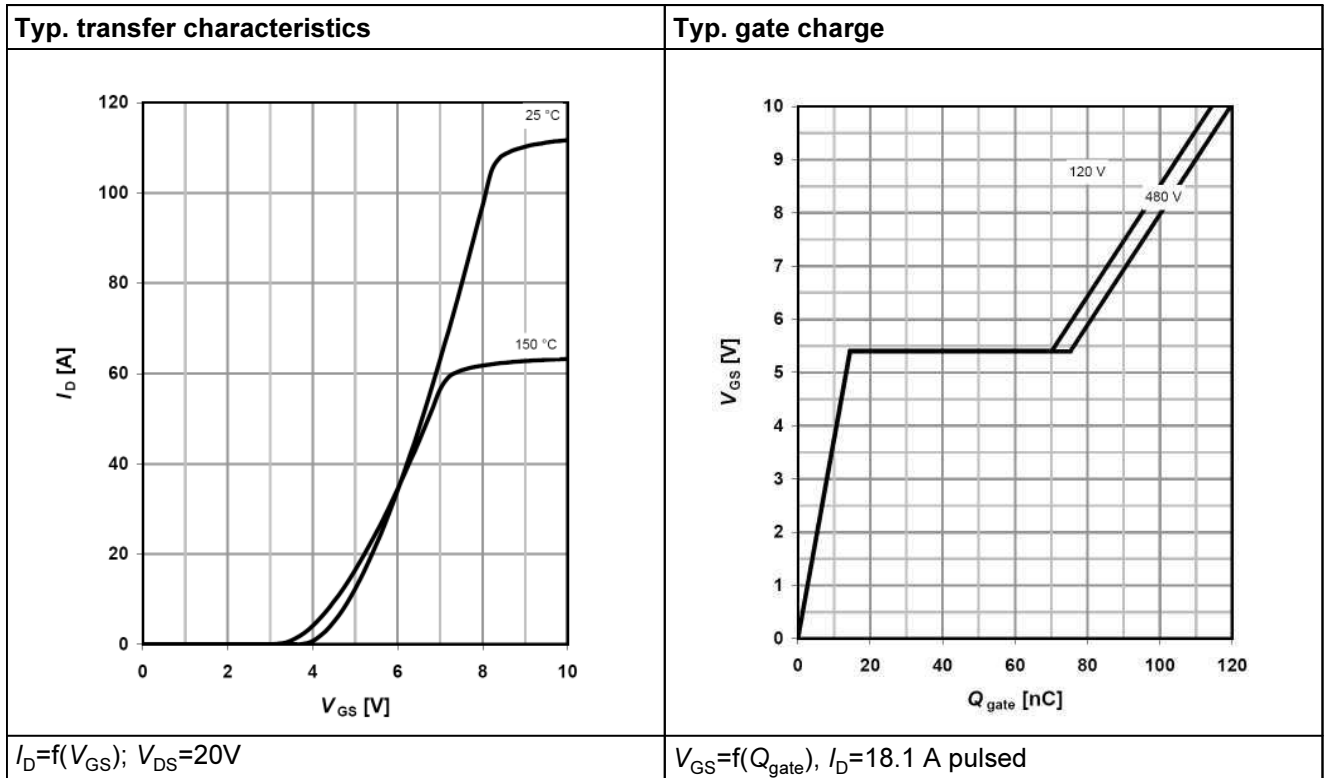

Table 17

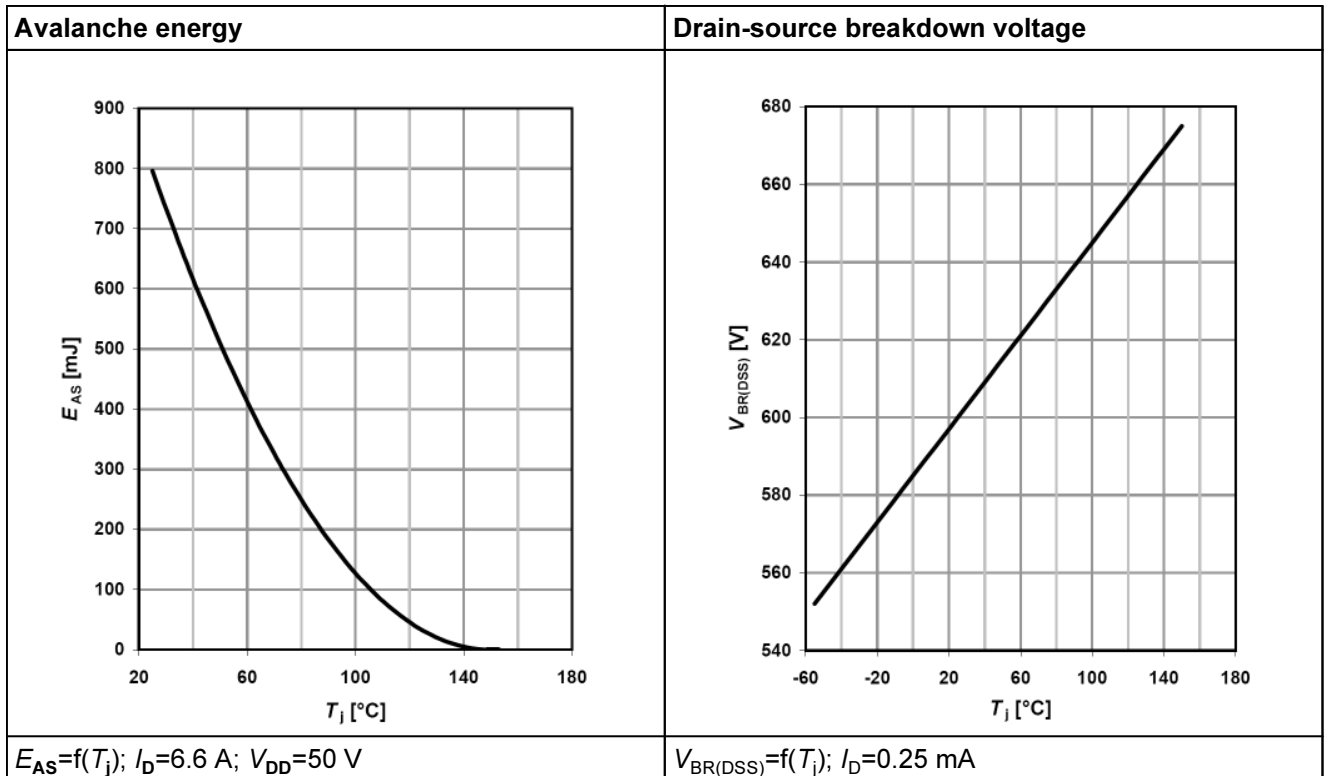

Table 18

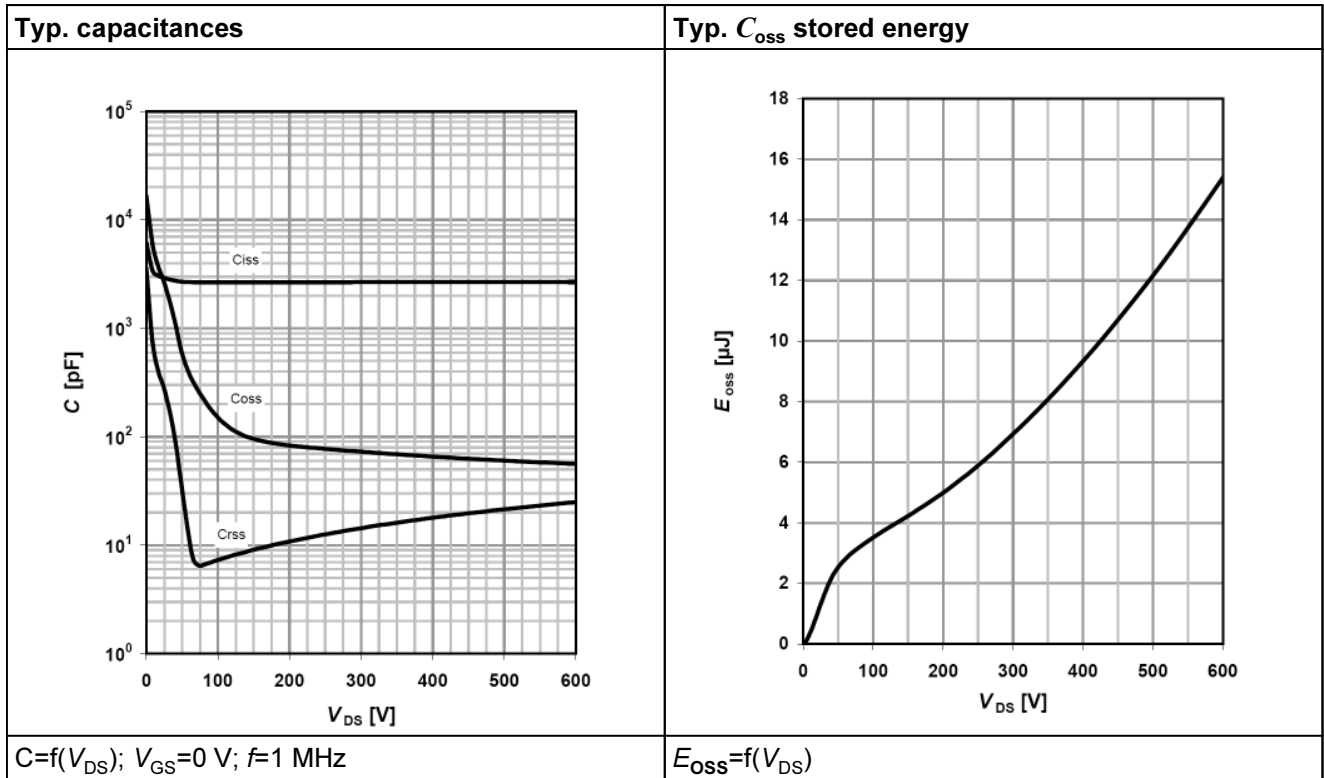
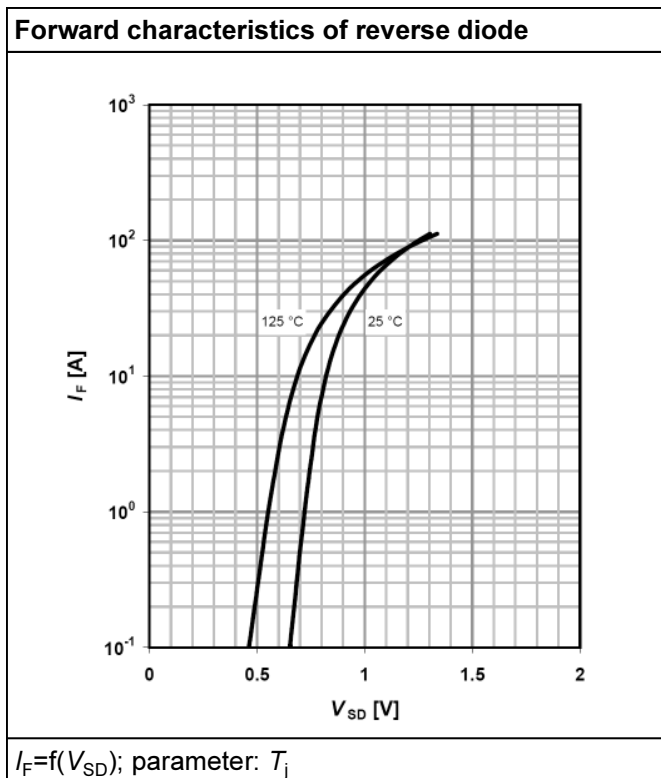

Table 19



## 6 Test circuits

Table 20 Switching times test circuit and waveform for inductive load

Switching times test circuit for inductive load	Switching time waveform

Table 21 Unclamped inductive load test circuit and waveform

Unclamped inductive load test circuit	Unclamped inductive waveform

Table 22 Test circuit and waveform for diode characteristics

Test circuit for diode characteristics	Diode recovery waveform

7 Package outlines

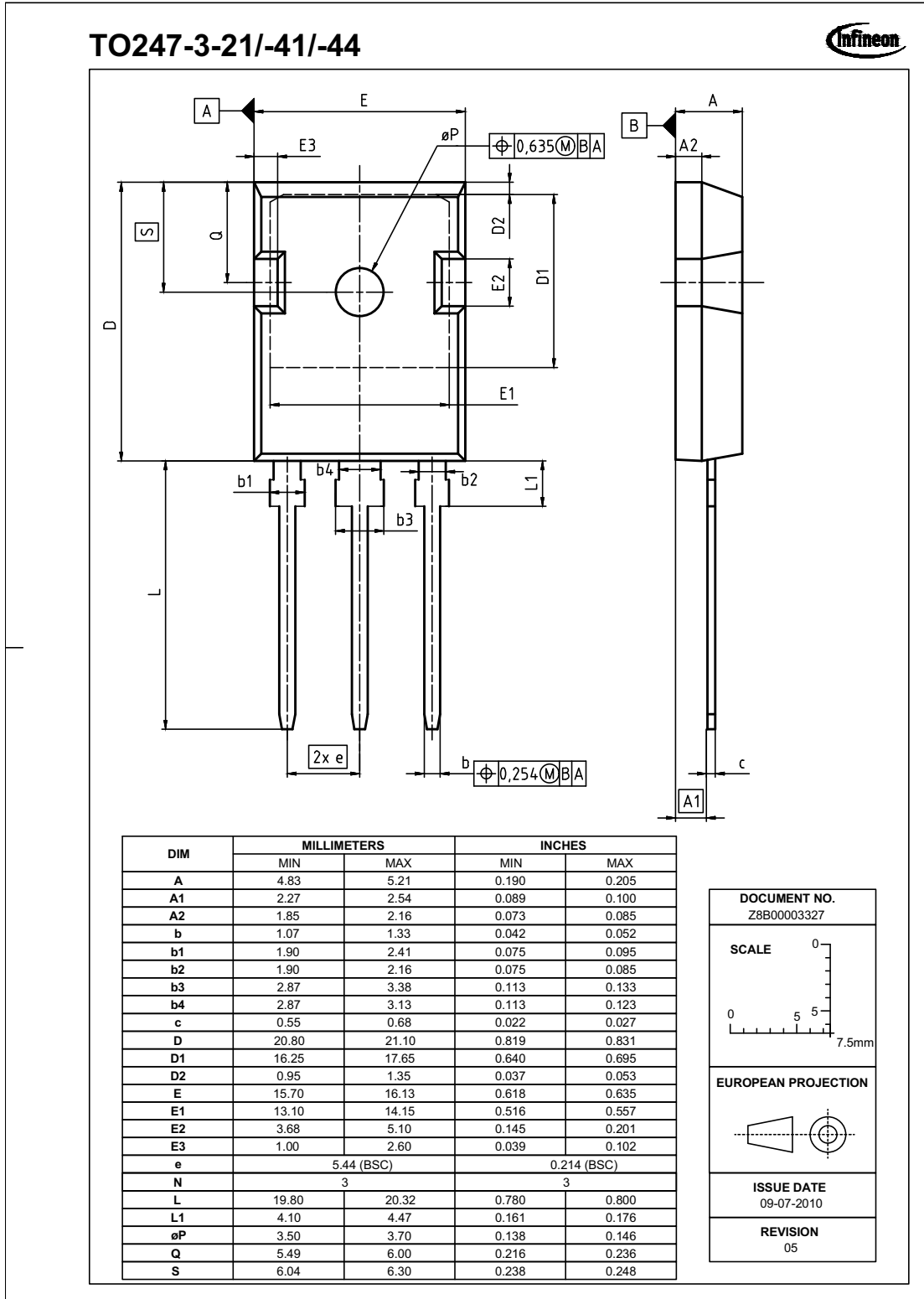
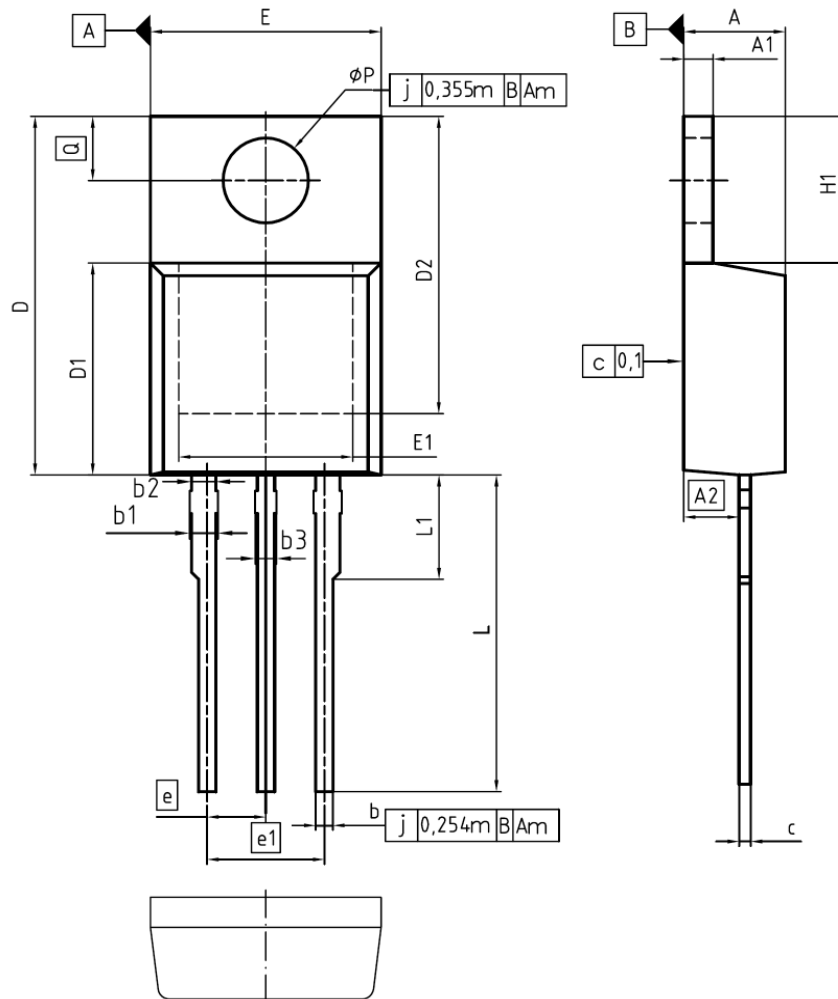

Figure 1 Outlines TO-247, dimensions in mm/inches



DIM	MILLIMETERS		INCHES	
	MIN	MAX	MIN	MAX
A	4.30	4.57	0.169	0.180
A1	1.17	1.40	0.046	0.055
A2	2.15	2.72	0.085	0.107
b	0.65	0.86	0.026	0.034
b1	0.95	1.40	0.037	0.055
b2	0.95	1.15	0.037	0.045
b3	0.65	1.15	0.026	0.045
c	0.33	0.60	0.013	0.024
D	14.81	15.95	0.583	0.628
D1	8.51	9.45	0.335	0.372
D2	12.19	13.10	0.480	0.516
E	9.70	10.36	0.382	0.408
E1	6.50	8.60	0.256	0.339
e	2.54		0.100	
e1	5.08		0.200	
N	3		3	
H1	5.90	6.90	0.232	0.272
L	13.00	14.00	0.512	0.551
L1	-	4.80	-	0.189
øP	3.60	3.89	0.142	0.153
Q	2.60	3.00	0.102	0.118

DOCUMENT NO.  
Z8B00003318

SCALE

EUROPEAN PROJECTION

ISSUE DATE  
23-08-2007

REVISION  
05

Figure 2 Outlines TO-220, dimensions in mm/inches

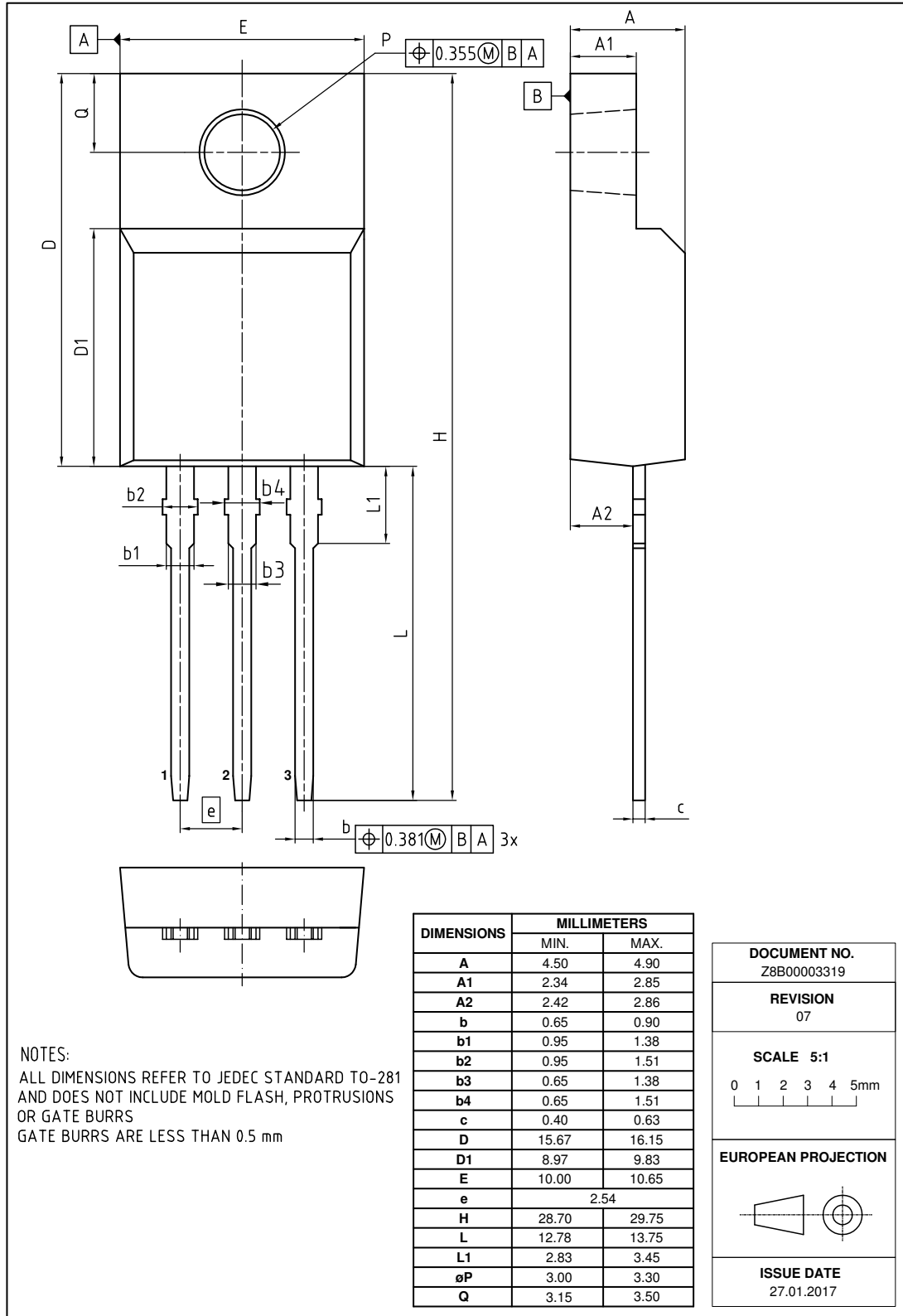

Figure 3 Outline PG-TO-220 FullPAK dimensions in mm



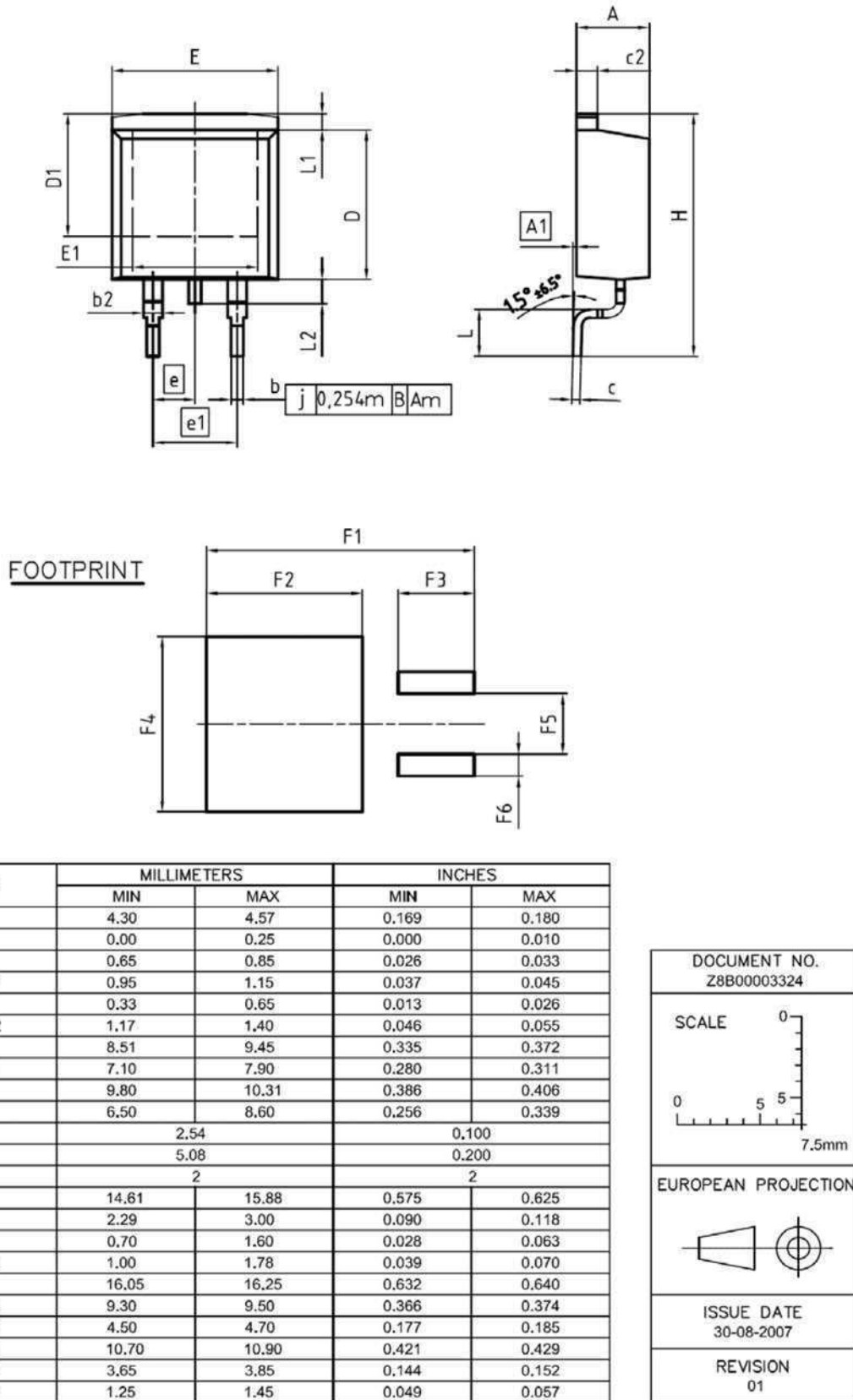

Figure 4 Outlines TO-263, dimensions in mm/inches

### Revision History

IPA60R099C6

**Revision: 2018-03-05, Rev. 2.3**

Previous Revision

Revision	Date	Subjects (major changes since last revision)
2.3	2018-03-05	Outline PG-TO220 FullPAK update

#### Trademarks of Infineon Technologies AG

AURIX™, C166™, CanPAK™, CIPOS™, CoolGaN™, CoolMOS™, CoolSET™, CoolSiC™, CORECONTROL™, CROSSAVE™, DAVE™, DI-POL™, DrBlade™, EasyPIM™, EconoBRIDGE™, EconoDUAL™, EconoPACK™, EconoPIM™, EiceDRIVER™, eupec™, FCOS™, HITFET™, HybridPACK™, Infineon™, ISOFACE™, IsoPACK™, i-Wafer™, MIPAQ™, ModSTACK™, my-d™, NovalithIC™, OmniTune™, OPTIGA™, OptiMOS™, ORIGA™, POWERCODE™, PRIMARION™, PrimePACK™, PrimeSTACK™, PROFET™, PRO-SIL™, RASIC™, REAL3™, ReverSave™, SatRIC™, SIEGET™, SIPMOS™, SmartLEWIS™, SOLID FLASH™, SPOC™, TEMPFET™, thinQ!™, TRENCHSTOP™, TriCore™.

Trademarks updated August 2015

#### Other Trademarks

All referenced product or service names and trademarks are the property of their respective owners.

#### We Listen to Your Comments

Any information within this document that you feel is wrong, unclear or missing at all? Your feedback will help us to continuously improve the quality of this document. Please send your proposal (including a reference to this document) to:

[erratum@infineon.com](mailto:erratum@infineon.com)

#### Published by

**Infineon Technologies AG**

**81726 München, Germany**

**© 2018 Infineon Technologies AG**

**All Rights Reserved.**

#### Legal Disclaimer

The information given in this document shall in no event be regarded as a guarantee of conditions or characteristics ("Beschaffheitsgarantie").

With respect to any examples, hints or any typical values stated herein and/or any information regarding the application of the product, Infineon Technologies hereby disclaims any and all warranties and liabilities of any kind, including without limitation warranties of non-infringement of intellectual property rights of any third party.

In addition, any information given in this document is subject to customer's compliance with its obligations stated in this document and any applicable legal requirements, norms and standards concerning customer's products and any use of the product of Infineon Technologies in customer's applications.

The data contained in this document is exclusively intended for technically trained staff. It is the responsibility of customer's technical departments to evaluate the suitability of the product for the intended application and the completeness of the product information given in this document with respect to such application.

#### Information

For further information on technology, delivery terms and conditions and prices please contact your nearest Infineon Technologies Office ([www.infineon.com](http://www.infineon.com)).

#### Warnings

Due to technical requirements, components may contain dangerous substances. For information on the types in question, please contact the nearest Infineon Technologies Office.

The Infineon Technologies component described in this Data Sheet may be used in life-support devices or systems and/or automotive, aviation and aerospace applications or systems only with the express written approval of Infineon Technologies, if a failure of such components can reasonably be expected to cause the failure of that life-support, automotive, aviation and aerospace device or system or to affect the safety or effectiveness of that device or system. Life support devices or systems are intended to be implanted in the human body or to support and/or maintain and sustain and/or protect human life. If they fail, it is reasonable to assume that the health of the user or other persons may be endangered.