



# IQS127 Datasheet

## IQ Switch<sup>®</sup> - ProxSense<sup>™</sup> Series

### Single Channel Capacitive Proximity/Touch Controller

The IQS127 ProxSense<sup>™</sup> IC is a fully integrated capacitive sensor produced in 2 variants:

- IQS127D:** Dual outputs (Touch and Proximity outputs).
- IQS127S:** Incorporating a Driven Shield.

**RoHS**  
compliant

#### Features

- Automatic Antenna Tuning Implementation (ATI) - Automatic adjustment for optimal performance.
- Internal Capacitor Implementation (ICI) – reference capacitor on-chip
- Supply voltage: 2V to 5.5V
- Minimum external components
- Data streaming option
- Advanced on-chip digital signal processing
- User selectable (OTP):
  - 4 Power Modes (15uA min)
  - IO sink / source
  - Time-out for stuck key
  - Output mode (Direct / Latch / Toggle)
  - Proximity and Touch Button sensitivity



6 pin TSOT23-6

Keys:	Touch:	5mm x 5mm or larger (overlay thickness dependent)
	Proximity:	Various electrical options (wire / PCB trace / ITO / conductive foil)
Dielectric:	Material:	Various non-metal materials (i.e. glass, plastic, painted surfaces)
	Thickness:	6 mm plastic, 10 mm glass

#### Applications

- LCD, Plasma & LED TVs
- GSM cellular telephones – On ear detection / touch keys
- LED flashlights or headlamps
- White goods and appliances
- Office equipment, toys, sanitary ware
- Flame proof, hazardous environment Human Interface Devices
- Proximity detection enables backlighting
- activation
- Wake-up from standby applications
- Replacement for electromechanical switches
- Find-In-The-Dark (FITD) applications
- Automotive: Door pocket lighting, electric window control
- GUI trigger on Proximity detected

#### Available options

T <sub>A</sub>	TSOT23-6
-40°C to 85°C	IQS127D
-40°C to 85°C	IQS127S



## Contents

<b>IQS127 DATASHEET .....</b>	<b>1</b>
<b>1 OVERVIEW .....</b>	<b>4</b>
1.1 APPLICABILITY.....	4
<b>2 ANALOGUE FUNCTIONALITY.....</b>	<b>4</b>
<b>3 PACKAGING AND PIN-OUT .....</b>	<b>5</b>
3.1 IQS127D.....	5
3.1.1 Pin-out.....	5
3.1.2 Schematic.....	5
3.1.3 Typical values.....	5
3.2 IQS127S .....	6
3.2.1 Pin-out.....	6
3.2.2 Schematic.....	6
3.2.3 Typical values.....	6
<b>4 USER CONFIGURABLE OPTIONS.....</b>	<b>7</b>
4.1 CONFIGURING OF DEVICES .....	7
<b>5 MEASURING CAPACITANCE USING THE CHARGE TRANSFER METHOD.....</b>	<b>9</b>
<b>6 DESCRIPTIONS OF USER OPTIONS .....</b>	<b>9</b>
6.1 PROXIMITY / TOUCH SENSOR.....	10
6.2 LOGIC SELECT FOR OUTPUT(S).....	10
6.3 OUTPUT PIN FUNCTION .....	10
6.3.1 Output function: Active.....	10
6.3.2 Output function: Latch (for $t_{LATCH}$ ).....	10
6.3.3 Output function: Toggle.....	11
6.4 PROXIMITY THRESHOLD.....	11
6.5 TOUCH THRESHOLD .....	11
6.6 POWER MODES .....	12
6.7 FILTERS USED BY THE IQS127.....	12
6.7.1 Long Term Average (LTA).....	12
6.7.2 IIR Raw Data filter.....	13
<b>7 1-WIRE DATA STREAMING MODE.....</b>	<b>14</b>
<b>8 ANTENNA TUNING IMPLEMENTATION (ATI).....</b>	<b>15</b>
8.1 AUTOMATIC ATI.....	15
8.2 IQS127 NOISE IMMUNITY.....	16
<b>9 ELECTRICAL SPECIFICATIONS .....</b>	<b>17</b>
9.1 ABSOLUTE MAXIMUM SPECIFICATIONS.....	17
9.2 GENERAL CHARACTERISTICS (MEASURED AT 25°C).....	17
9.3 OUTPUT CHARACTERISTICS (MEASURED AT 25°C).....	18
9.4 ELECTROMAGNETIC COMPATIBILITY .....	19
9.4.1 Electrostatic discharge (ESD) .....	19
9.4.2 EMI (Radio frequency Interference) – IEC61000-4-3.....	20
9.4.3 Static Latch-Up (LU).....	20
9.5 TIMING CHARACTERISTICS.....	21
9.6 PACKAGING INFORMATION.....	22
9.7 PACKAGE MSL .....	22
<b>10 DATASHEET AND PART-NUMBER INFORMATION .....</b>	<b>23</b>



---

10.1	ORDERING INFORMATION .....	23
10.2	STANDARD DEVICES .....	23
10.3	DEVICE PACKAGING CONVENTION .....	24
10.3.1	<i>Top</i> .....	24
10.3.2	<i>Bottom</i> .....	24
10.4	DATASHEET REVISION HISTORY .....	24
<b>11</b>	<b>CONTACT INFORMATION .....</b>	<b>25</b>



## 1 Overview

The IQS127 family is a single channel capacitive proximity and touch device which employs an internal voltage regular and reference capacitor (Cs).

The IQS127D device has a dedicated pin for the connection of a sense antenna (Cx) and output pins for proximity events on POUT and touch event on TOUT. The output pins can be configured for various output methods including a serial data streaming option on TOUT.

The IQS127S employs an active driven shield pin, which replaces the POUT pin, to drive a shield for protection of the sense antenna signal. The TOUT pin becomes a general OUT pin in the IQS127S, which is configurable either as a proximity output or a touch output.

## 2 Analogue Functionality

The analogue circuitry measures the capacitance of a sense antenna attached to the Cx pin through a charge transfer process (refer to section 5) that is periodically initiated by the digital circuitry. The measuring process is referred to a conversion and consists of the discharging of reference capacitor and Cx, the charging of Cx and then a series of charge transfers from Cx to Cs until a trip voltage is reached. The number of charge transfers required to reach the trip voltage is referred to as the current sample (CS).

Device configuration is determined by one time programmable (OTP) options.

The devices automatically track slow varying environmental changes via various filters, detect noise and has an automatic Antenna Tuning Implementation (ATI) to tune the device to the sense antenna.

### 1.1 Applicability

All specifications, except where specifically mentioned otherwise, provided by this datasheet are applicable to the following ranges:

- Temperature: -40C to +85C
- Supply voltage ( $V_{DDHI}$ ): 2.95V to 5V
- Supply voltage ( $V_{DDHI}$ ): 2.V to 5V – Low voltage device

The capacitance measurement circuitry makes use of an internal Cs and voltage reference ( $V_{REF}$ ).

The analogue circuitry further provides functionality for:

- Power on reset (POR) detection.
- Brown out detection (BOD).
- Detection of a watch dog timer (WDT) expiry.

The IQS127S employs circuitry to drive a shield that will follow the voltage sensed on Cx.



### 3 Packaging and Pin-out

The IQS127D and IQS127S are available in a TSOT23-6 package.

#### 3.1 IQS127D

##### 3.1.1 Pin-out

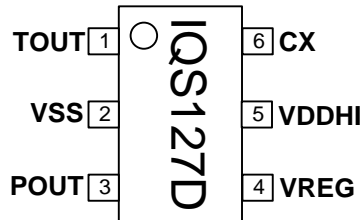
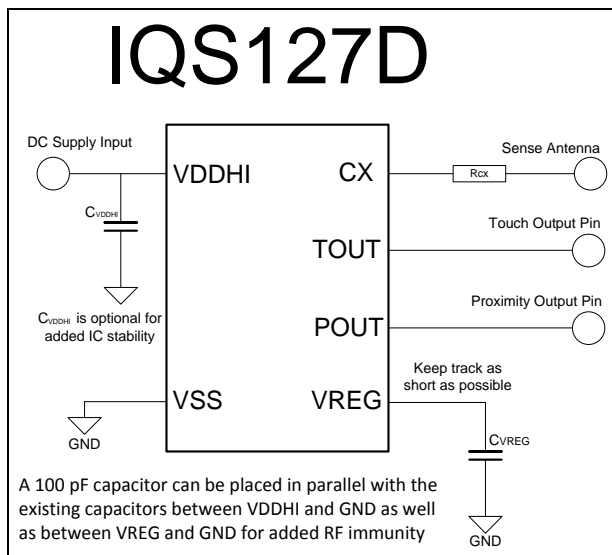

**Figure 3.1 Pin-out of IQS127D package**

**Table 3.1 Pin-out description**

IQS127D			
Pin	Name	Type	Function
1	TOUT	Digital Out	Touch Output
2	VSS	Ground	GND Reference
3	POUT	Digital Out	Proximity Output
4	VREG	Analogue Output	Internal Regulator Pin
5	VDDHI	Supply Input	Supply Voltage Input
6	CX	Analogue I/O	Sense Antenna

##### 3.1.2 Schematic



**Figure 3.2 Typical application schematic of IQS127D**

##### 3.1.3 Typical values

Component	Value
C <sub>VREG</sub>	1uF
R <sub>CX</sub>	470 Ω (typical)
C <sub>VDDHI</sub>	1uF



## 3.2 IQS127S

### 3.2.1 Pin-out

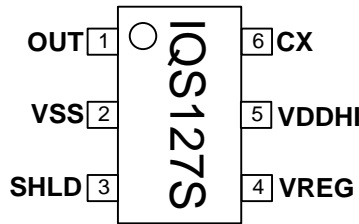

Figure 3.3 Pin-out of IQS127S package

Table 3.2 Pin-out description

IQS127S			
Pin	Name	Type	Function
1	OUT	Digital Out	Touch or Proximity Output
2	VSS	Ground	GND Reference
3	SHLD	Analogue Output	Shield Output
4	VREG	Analogue Output	Internal Regulator Pin
5	VDDHI	Supply Input	Supply Voltage Input
6	CX	Analogue I/O	Sense Antenna

### 3.2.2 Schematic

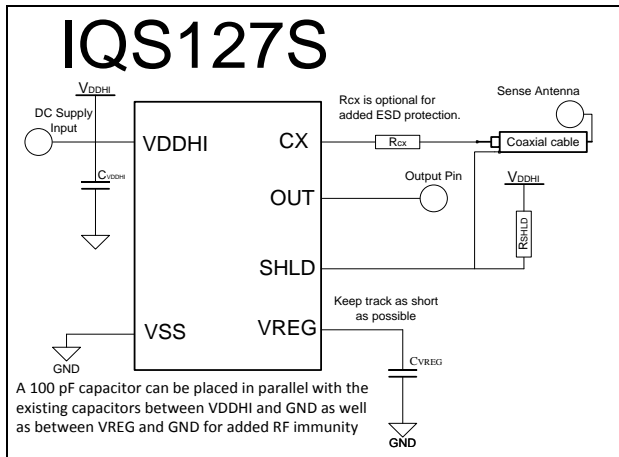

Figure 3.4 Typical application schematic of IQS127S

### 3.2.3 Typical values

Component	Value
$C_{VREG}$	1uF
$R_{CX}$	470 $\Omega$ (typical)
$C_{VDDHI}$	1uF
$R_{SHLD}$	2k $\Omega$ to $\infty$

Note: Lower values of  $R_{SHLD}$  provide a better shielding effect but require more current.



## 4 User Configurable Options

The IQS127 provides One Time Programmable (OTP) user options (each option can be modified only once). The device is fully functional in the default (unconfigured) state. OTP options are intended for specific applications.

The configuration of the device can be done on packaged devices or in-circuit. In-circuit configuration may be limited by values of external components chosen.

A number of standard device configurations are available (refer to Table 10.1). Azoteq can supply pre-configured devices for large quantities.

### 4.1 Configuring of Devices

Azoteq offers a Configuration Tool (CTxxx) and accompanying software (USBProg.exe) that can be used to program the OTP user options for prototyping purposes. More details regarding the configuration of the device with the USBProg program is explained by application note: “AZD007 – USBProg Overview” which can be found on the Azoteq website.

Alternate programming solutions of the IQS127 also exist. For further enquiries regarding this matter please contact Azoteq at ProxSenseSupport@azoteq.com or the local distributor

**Table 4-1: User Selectable Configuration Options: Bank 0**

T <sub>THR1</sub>	T <sub>THR0</sub>	P <sub>THR1</sub>	P <sub>THR0</sub>	FUNC1	FUNC0	LOGIC	PT
bit 7							bit 0
Bank 1: bit 0, Bank 0: bit 7-6	<b>T<sub>THR&lt;2:0&gt;</sub></b> : Touch Thresholds			-Section 6.5			
	000 = 1/16 001 = 1/32 010 = 2/16 011 = 3/16 100 = 4/16 101 = 6/16 110 = 8/16 111 = 10/16						
Bank0: bit 5-4	<b>P<sub>THR&lt;1:0&gt;</sub></b> : Proximity Thresholds			-Section 6.4			
	00 = 2 01 = 4 10 = 8 11 = 16						
Bank0: bit 3-2	<b>FUNC&lt;1:0&gt;</b> : OUTPUT Pins' functions			-Section 6.3			
	<u><b>IQS127D</b></u> 00 = POUT active, TOUT active 01 = POUT latch, TOUT active 10 = POUT active, TOUT toggle 11 = POUT latch, TOUT toggle						
	<u><b>IQS127S</b></u> 00 = OUT active 01 = OUT latch (for t <sub>LATCH</sub> ) 10 = OUT toggle 11 = Unimplemented, read as '00'						
Bank0: bit 1	<b>LOGIC</b> : Output logic select -			-Section 6.2			
	0 = Active Low 1 = Active High						
Bank0: bit 0	<b>PT</b> : Proximity / Touch Output (IQS127S only)			-Section 6.1			
	0 = Touch 1 = Proximity output						



**Table 4-2: User Selectable Configuration Options: Bank 1**

STREAMING	-	SHORT STREAMING	t <sub>HALT1</sub>	t <sub>HALT0</sub>	P <sub>MODE1</sub>	P <sub>MODE0</sub>	T <sub>THR2</sub>
-----------	---	-----------------	--------------------	--------------------	--------------------	--------------------	-------------------

bit 7

bit 0

Bank 1: bit 7     **STREAMING:** 1-wire streaming mode     -Section 0  
 0 = disabled  
 1 = enabled

Bank1: bit 6     **Not used**

Bank1: bit 5     **SHORT STREAMING:** Short word streaming enable  
 (Function enabled if this bit together with STREAMING bit is set) –Section 0

Bank1: bit 4-3     **t<sub>HALT<1:0></sub>:** Halt time of Long Term Average     -Section 6.7  
 00 = 18.6 seconds  
 01 = 74.5 seconds  
 10 = Never  
 11 = Always

Bank1: bit 2-1     **P<sub>MODE<1:0></sub>:**Power Modes     -Section 6.6  
 00 = Boost Mode  
 01 = Normal Power Mode  
 10 = Low Power Mode 1  
 11 = Low Power Mode 2

Bank1: bit 0     **T<sub>THR<2:0></sub>:** Touch Thresholds     -Section 6.5  
 See Table 4-1





## 5 Measuring capacitance using the *Charge Transfer* method

The *charge transfer* method of capacitive sensing is employed on the IQS127. (The charge transfer principle is thoroughly described in the application note: “AZD004 - Azoteq Capacitive Sensing”.)

A charge cycle is used to take a measurement of the capacitance of the sense antenna (connected to Cx) relative to ground. It consists of a series of pulses charging Cx and discharging Cx to the reference capacitor, at the charge transfer frequency (FCX - refer to Section 9). The count of the pulses required to reach a trip voltage on the reference capacitor is referred to as a **current sample** (CS) which is the instantaneous capacitive measurement. The CS is used to determine if either a physical contact or proximity event occurred (refer to section 6.7.1), based on the change in CS detected. The typical values of CS, without a touch or proximity condition range between 650 and 1150, although higher and lower counts can be used based on the application requirements. With CS larger than +/-1150

the gain of the system may become too high causing unsteady current samples.

The IQS127 schedules a charge cycle every  $t_{SAMPLE}$  seconds to ensure regular samples for processing of results. The duration of the charge cycle is defined as  $t_{CHARGE}$ . (refer to 0) and varies according to the counts required to reach the trip voltage. Following the charge cycle other activities such as data streaming is completed (if in streaming mode), before the next charge cycle is initiated.

**Please note: Attaching a probe to the Cx pin will increase the capacitance of the sense plate and therefore CS. This may have an immediate influence on CS (decrease  $t_{CHARGE}$  – thus CS) and cause a proximity or touch event. After  $t_{HALT}$  seconds the system will adjust to accommodate for this change. If the total load on Cx, with the probe attached is still lower than the maximum Cx load the system will continue to function normally after  $t_{HALT}$  seconds with the probe attached.**

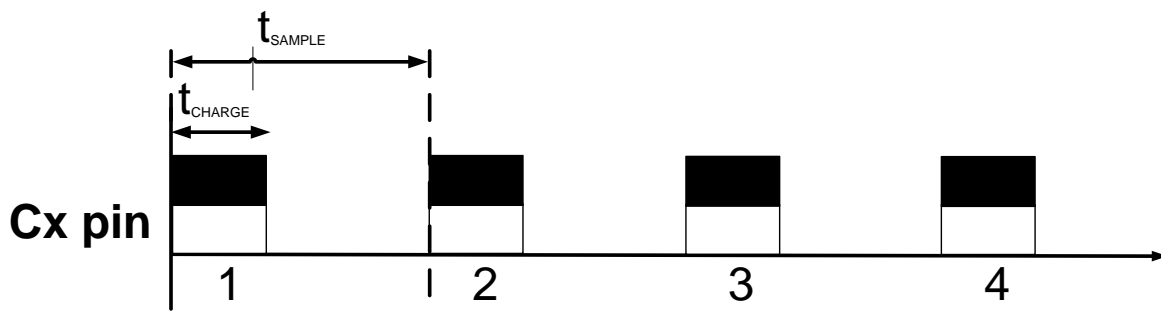

Figure 5.1 Charge cycles as can be seen on Cx

## 6 Descriptions of User Options

This section describes the individual user programmable options of the IQS127 in more detail.

User programmable options are programmed to One Time Programmable (OTP) fuse registers (refer to section 1). The options differ slightly between the IQS127D and IQS127S devices.

**Note:**

- HIGH=Logical ‘1’ and LOW=Logical ‘0’.
- The following sections are explained with the OUT, POUT and TOUT taken as ‘Active LOW’.
- The default is always where bits are set to 0.



Refer to section 0 for the sourcing and sinking capabilities of OUT, POUT and TOUT. These pins are sourced from V<sub>DDHI</sub> and will be turned HIGH (when active high) for a minimum time of t<sub>HIGH</sub>, and LOW for a minimum time of t<sub>LOW</sub> (when active low).

### 6.1 Proximity / Touch Sensor

The IQS127S can either be configured to provide a Proximity or a Touch (default) output on the OUT pin.

The IQS127D provides a Proximity output on POUT and a Touch output on TOUT, and does not need to be configured.

Both devices will provide proximity and touch data while streaming (refer to section 0)

#### Configuration: Bank0 bit0

<b>PT: Proximity / Touch Output (IQS127S only)</b>	
<b>Bit</b>	<b>Selection</b>
0	Touch output
1	Proximity output

### 6.2 Logic select for output(s)

The logic used by the device can be selected as active HIGH or active LOW. The output pins POUT, TOUT and OUT will function based on the selection.

#### Configuration: Bank0 bit1

**LOGIC:** Output logic select -

<b>Bit</b>	<b>Selection</b>
0	Active Low
1	Active High

### 6.3 Output pin function

Various options for the function of the output pin(s) are available. These are selected as follow:

#### Configuration: Bank0 bit2-3

**FUNC1:FUNC0** OUTPUT Pins' functions

<b>IQS127D</b>	
<b>Bit</b>	<b>Selection</b>
00	POUT active, TOUT active
01	POUT latch, TOUT active
10	POUT active, TOUT toggle
11	POUT latch, TOUT toggle
<b>IQS127S</b>	
<b>Bit</b>	<b>Selection</b>
00	OUT active
01	OUT latch (for t <sub>LATCH</sub> )
10	OUT toggle
11	Unimplemented, read as '00'

#### 6.3.1 Output function: Active

With a Proximity or Touch event, the output pin will change to LOW and stay LOW for as long as the event remains (see Figure 6.1). Also refer to the use of t<sub>HALT</sub> section 6.7.1 that may cause the termination of the event.

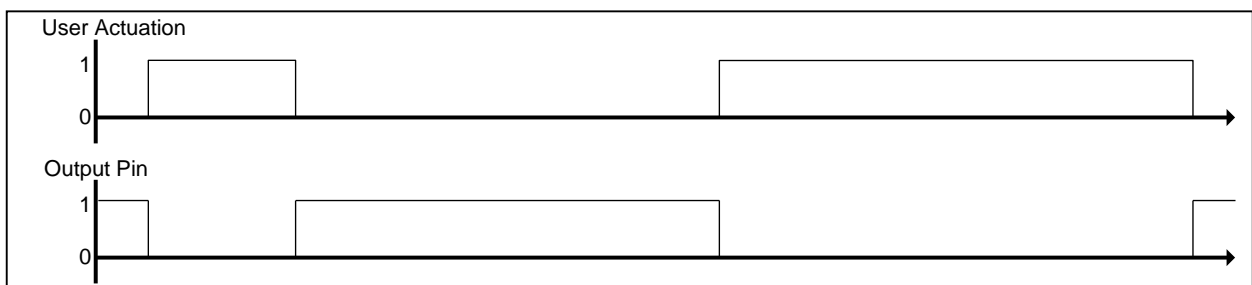

Figure 6.1 Active Mode Output Configuration

#### 6.3.2 Output function: Latch (for t<sub>LATCH</sub>)

With a Proximity or Touch event, the output pin will latch LOW for t<sub>LATCH</sub> seconds.

When the event terminates prior to t<sub>LATCH</sub> the output pin will remain LOW.

When the event remains active longer than t<sub>LATCH</sub> the output pin will remain LOW as long as the event remains active (see Figure 6.2).

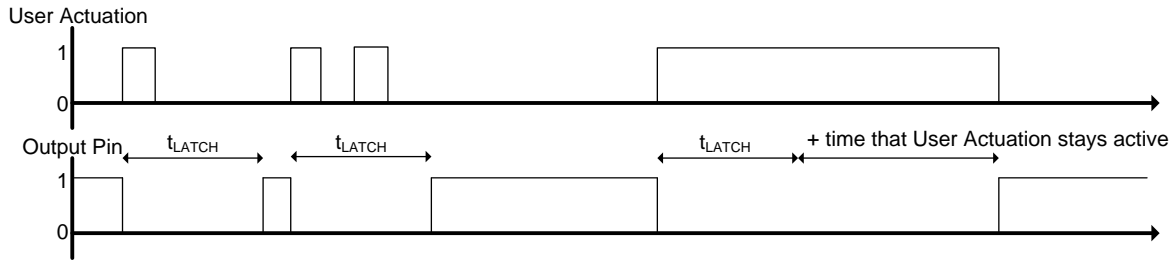

Figure 6.2 Latch Mode Output Configuration

### 6.3.3 Output function: Toggle

The output pin will toggle with every Proximity or Touch event occurring. Thus when an event

occurs and the output is LOW the output will become HIGH and when the output is HIGH the output will become LOW (see Figure 6.3).

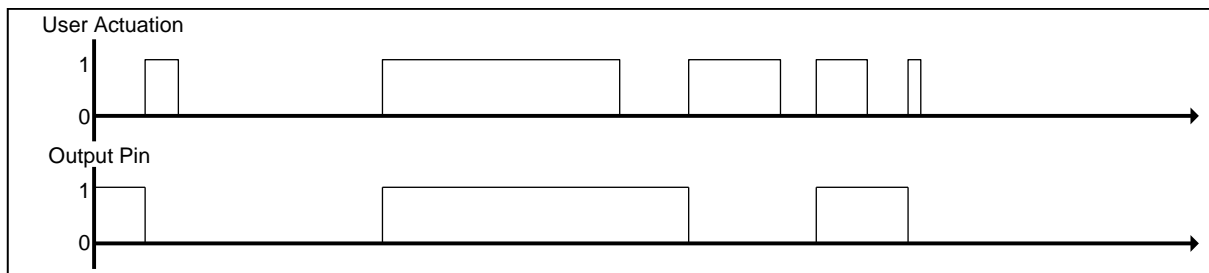

Figure 6.3 Toggle Mode Output Configuration

### 6.4 Proximity Threshold

The IQS127 has 4 proximity threshold settings. The proximity threshold is selected by the designer to obtain the desired sensitivity and noise immunity. The proximity event is triggered based on the selected proximity threshold; the CS and the LTA (Long Term Average). The threshold is expressed in terms of counts; the same as CS (refer to 5)

designer to obtain the desired touch sensitivity. The touch threshold is expressed as a fraction of the LTA as follows:

$$T_{TH} = \text{Selected Touch Threshold} \times LTA$$

Where LTA is the Long Term Average (refer to 6.7.1)

The touch event is triggered based on  $T_{TH}$ , CS and LTA. A touch event is identified when for at least 3 consecutive samples the following equation holds:

$$T_{TH} \leq LTA - CS$$

With lower average CS (therefore lower LTA) values the touch threshold will be lower and visa versa.

#### Configuration: Bank0 bit4-5

$P_{THR1}:P_{THR0}$ Proximity Thresholds	
Bit	Selection
00	2 (Most sensitive)
01	4
10	8
11	16 (Least sensitive)

A proximity event is identified when for at least 6 consecutive samples the following equation holds:

$$P_{TH} \leq LTA - CS$$

Where LTA is the Long Term Average (refer to 6.7.1)

### 6.5 Touch Threshold

The IQS127 has 8 touch threshold settings. The touch threshold is selected by the



### Configuration: Bank0 bit6-7 and Bank1 bit1

**T<sub>THR2</sub>:T<sub>THR0</sub>: Touch Thresholds**

Bit	Selection
000	1/16
001	1/32 (Most sensitive)
010	2/16
011	3/16
100	4/16
101	6/16
110	8/16
111	10/16 (Least sensitive)

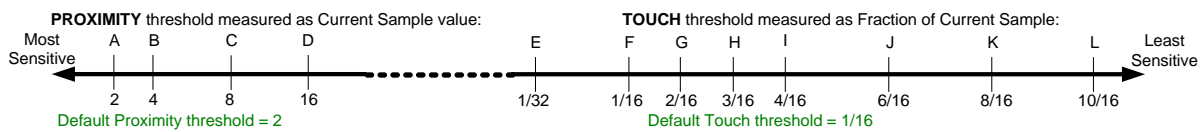

**Figure 6.4 Proximity and Touch Thresholds**

## 6.6 Power Modes

The IQS127 IC has four power modes specifically designed to reduce current consumption for battery applications.

The power modes are basically implemented around the occurrence of charge cycle every  $t_{SAMPLE}$  seconds (refer to section 5). The fewer charge transfer cycles that need to occur per second the lower the power consumption (but decreased response time).

During Boost Power Mode (BP), charge cycles are initiated approximately every 9ms.

Additional Power Modes are provided. While in any power mode the device will zoom to BP

whenever a current sample (CS) indicates a possible proximity or touch event. The device will remain in BP for  $t_{ZOOM}$  seconds and then return to the selected power mode. The Zoom function allows reliable detection of events with current samples being produced at the BP rate.

**Table 6-1: Power Mode configuration (Bank1 bit[3:2])**

Bit	Power Mode timing	$t_{SAMPLE}$ (ms)
00	$t_{BP}$ (default)	BP (9ms)
01	$t_{NP}$	50
10	$t_{LP1}$	100
11	$t_{LP2}$	200



**Figure 6.5 LP Modes: Charge cycles**

## 6.7 Filters used by the IQS127

The IQS127 devices employ various signal processing functions that includes the execution of various filters as described below.

### 6.7.1 Long Term Average (LTA)

Capacitive touch devices detect changes in capacitance that are not always related to the intended proximity or touch of a human. This is a result of changes in the



environment of the sense plate and other factors. These changes need to be compensated for in various manners in order to reliably detect touch events and especially to detect proximity events. One mechanism the IQS127 employs is the use of a Long Term Averaging filter (IIR type filter) which tracks slow changes in the environment (expressed as changes in the current sample). The result of this filter is a Long Term Average (LTA) value that forms a dynamic reference used for various functions such as identification of proximity and touch events.

The LTA is calculated from the current samples (CS). The filter only executes while no proximity or touch event is detected to ensure compensation only for environmental changes. However there may be instances where sudden changes in the environment or changes in the environment while a proximity or touch event has been detected cause the CS to drift away from the LTA. To compensate for these situations a Halt Timer ( $t_{HALT}$ ) has been defined.

The Halt Timer is started when a proximity or touch event occurs and when it expires the LTA filter is recalibrated. Recalibration causes  $LTA < CS$ , thus the disappearance of proximity or touch events (refer to 6.4 and 6.5).

The designer needs to select a Halt Timer value to best accommodate the required application.

**Configuration: Bank1 bit4-5**

$t_{HALT1}:t_{HALT0}$ : Halt time of Long Term Average	
Bit	Selection
00	18.6 seconds
01	74.5 seconds

10	NEVER
11	ALWAYS

Notes:

- The “NEVER” option indicates that the execution of the filters will never be halted.
- With the ‘ALWAYS’ option and the detection of a proximity event the execution of the filter will be halted for only 18.6 seconds and with the detection of a touch event the execution of the filter will be halted as long as the touch condition applies.

Refer to Application note “AZD024 - Graphical Representation of the IIR Filter” for detail regarding the execution of the LTA filter.

**6.7.2 IIR Raw Data filter**

The extreme sensitivity of the IQS127 makes it susceptible to external noise sources. This causes a decreased signal to noise (S/N) ratio, which could potentially cause false event detections.

Noise can also couple into the device as a result of poor PCB, sense antenna design and other factors influencing capacitive sensing devices.

In order to compensate for noise the IQS127 uses an IIR filter on the raw data to minimize result of noise in the current sample. This filter is implemented on all of the IQS127 devices, and cannot be disabled.



## 7 1-Wire Data Streaming Mode

The IQS127 has the capability to stream data to a MCU. This provides the designer with the capability to obtain the parameters within the device in order to aid design into applications. Data streaming may further be used by an MCU to control events or further process results obtained from the IQS127 devices. Data streaming is performed as a 1-wire data protocol on one of the output pins (TOUT for IQS127D devices and OUT for IQS127S devices). The function of this pin is therefore lost when the device is put in streaming mode. Data Streaming can be enabled as indicated below:

### Configuration: Bank1 bit8

**STREAMING:** 1-wire data streaming mode

Bit	Selection
0	Disabled
1	Enabled

The IQS127D has a short data streaming mode where a reduced set of data is streamed to the MCU. This option can be used only when data streaming has been activated.

### Configuration: Bank1 bit6

**SHORT STREAMING:** Short data streaming

Bit	Selection
0	Disabled
1	Enabled

Data streaming is initiated by the IQS127. When data streaming is enabled data is sent following each charge cycle (refer to 5).

Figure 7.1 illustrates the communication protocol for initialising and sending data with the 1 wire communication protocol.

1. Communication is initiated by a START bit. Bit defined as a low condition for  $t_{START}$ .
2. Following the START bit, is a synchronisation byte ( $T_{INIT} = 0xAA$ ). This byte is used by the MCU for clock synchronisation.
3. Following  $T_{INIT}$  the data bytes will be sent. With short data streaming mode enabled, 5 bytes of data will be sent, otherwise 8 bytes will be sent after each charge cycle.
4. Each byte sent will be preceded by a START bit and a STOP bit will follow every byte.
5. STOP bit indicated by taking pin 1 high. The STOP bit does not have a defined period.

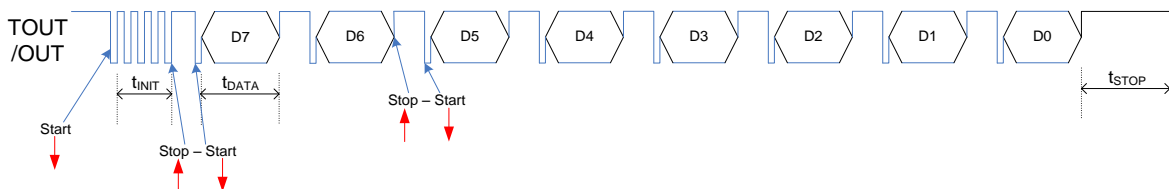

**Figure 7.1** 1-wire data streaming mode

The following tables define the data streamed from the IQS127 devices during Short Data Streaming and Normal Data Streaming modes.



**Table 7.1 Byte Definitions for Short Data Streaming Mode**

Byte	Bit	Value
0	7:0	Current sample High byte
1	15:8	Current sample Low byte
4	23	Proximity event detected
	22	Touch event detected
	21	Not used (always 0)
	20	Zoom active
	19	Non-user data
	18	Non-user data
	17	Non-user data
	16	Non-user data

**Table 7.2 Byte Definitions for Normal Data Streaming Mode**

Byte	Bit	Value
0	7:0	CS High byte
1	15:8	CS Low byte
2	23:16	LTA High byte
3	31:24	LTA Low byte
4	39	ATI busy
	38	Compensation (P5)
	37	P <sub>TH0</sub> – Proximity threshold
	36	P <sub>TH1</sub> – Proximity threshold
	35	Not used (always 0)
	34	Zoom active
	33	Touch event detected
	32	Proximity event detected
5	47	ATI Multiplier (I)
	46	ATI Multiplier (S)
	45	ATI Multiplier (S)
	44	Compensation (P4)
	43	Compensation (P3)
	42	Compensation (P2)
	41	Compensation (P1)
	40	Compensation (P0)
6	55:48	Non-user data
7	63:56	Counter

Azoteq provides an application tool: “VisualProxSense” that can be utilised to capture and visualise the data streamed from the IQS127 (refer to application note AZD006 – VisualProxSense Overview).

Long 1-wire data streaming mode used when all data is required from IC. Short 1-wire data streaming mode used when only instantaneous measurement and Prox/Touch event is needed.

Sample code available: “AZD017 - IQS127 1-Wire Protocol SAMPLE CODE”

## 8 Antenna Tuning Implementation (ATI)

ATI is a sophisticated technology implemented in the latest generation ProxSense™ devices that optimises the performance of the sensor in a wide range of applications and environmental conditions (refer to application note AZD0027 - Antenna Tuning Implementation).

ATI makes adjustments through external reference capacitors (as required by most other solutions) to obtain optimum performance.

ATI adjusts internal circuitry according to two parameters, the ATI multiplier and the ATI compensation. The ATI multiplier can be viewed as a course adjustment and the ATI compensation as a fine adjustment.

The adjustment of the ATI parameters will result in variations in the current sample and sensitivity. Sensitivity can be observed as the change in current sample as the result of a fixed change in sensed capacitance. The ATI parameters have been chosen to provide significant overlap. It may therefore be possible to select various combinations of ATI multiplier and ATI compensation settings to obtain the same current sample. The sensitivity of the various options may however be different for the same current sample.

### 8.1 Automatic ATI

The IQS127 implements an automatic ATI algorithm. This algorithm automatically adjusts the ATI parameters to optimise the sensing antenna’s connection to the device.

The device will execute the ATI algorithm whenever the device starts-up and when the



current samples are not within a predetermined range.

While the Automatic ATI algorithm is in progress this condition will be indicated in the streaming data and proximity and touch events cannot be detected. The device will only briefly remain in this condition and it will be entered only when relatively large shifts in the current sample has been detected.

The automatic ATI function aims to maintain a constant current sample, regardless of the capacitance of the sense antenna (within the maximum range of the device).

The effects of auto-ATI on the application are the following:

- Automatic adjustment of the device configuration and processing parameters for a wide range of PCB and application designs to maintain an optimal configuration for proximity and touch detection.
- Automatic tuning of the sense antenna at start-up to optimise the sensitivity of the application.
- Automatic re-tuning when the device detects changes in the sensing antenna's capacitance to accommodate a large range of changes in the environment of the application that influences the sensing antenna.
- Re-tuning only occurs during device operation when a relatively large sensitivity reduction is detected. This is to ensure smooth operation of the device during operation.
- Re-tuning may temporarily influence the normal functioning of the device, but in most instances the effect will be hardly noticeable.
- Shortly after the completion of the re-tuning process the sensitivity of a Proximity detection may be reduced slightly for a few seconds as internal filters stabilise.

Automatic ATI can be implemented so effectively due to:

- Excellent system signal to noise ratio (SNR).
- Effective digital signal processing to

remove AC and other noise.

- The very stable core of the devices.
- The built in capability to accommodate a large range of sensing antenna capacitances.

## 8.2 IQS127 Noise Immunity

The IQS127 has advanced immunity to RF noise sources such as GSM cellular telephones, DECT, Bluetooth and WIFI devices. Design guidelines should however be followed to ensure the best noise immunity. The design of capacitive sensing applications can encompass a large range of situations but as a summary the following should be noted to improve a design:

- A ground plane should be placed under the IC, except under the Cx line.
- All the tracks on the PCB must be kept as short as possible.
- The capacitor between  $V_{DDHI}$  and  $V_{SS}$  as well as between  $V_{REF}$  and  $V_{SS}$ , must be placed as close as possible to the IC.
- A 100 pF capacitor can be placed in parallel with the 1uF capacitor between  $V_{DDHI}$  and  $V_{SS}$ . Another 100 pF capacitor can be placed in parallel with the 1uF capacitor between  $V_{REF}$  and  $V_{SS}$ .
- When the device is too sensitive for a specific application a parasitic capacitor (max 5pF) can be added between the Cx line and ground.
- Proper sense antenna and button design principles must be followed.
- Unintentional coupling of sense antenna to ground and other circuitry must be limited by increasing the distance to these sources or making use of the driven shield.
- In some instances a ground plane some distance from the device and sense antenna may provide significant shielding from undesired interference.
- When then the capacitance between the sense antenna and ground becomes too large the sensitivity of the device may be influenced.





## 9 Electrical Specifications

### 9.1 Absolute Maximum Specifications

Exceeding these maximum specifications may cause damage to the device.

Operating temperature	-40°C to 85°C
Supply Voltage ( $V_{DDHI} - V_{SS}$ )	5.5V
Maximum pin voltage (OUT, T <sub>OUT</sub> , P <sub>OUT</sub> )	$V_{DDHI} + 0.5V$
Pin voltage (Cx)	2.5V
Minimum pin voltage (VDDHI, VREG, OUT, T <sub>OUT</sub> , P <sub>OUT</sub> , Cx)	$V_{SS} - 0.5V$
Minimum power-on slope	100V/s
ESD protection <sup>1</sup> (VDDHI, VREG, V <sub>SS</sub> , T <sub>OUT</sub> /OUT, P <sub>OUT</sub> /SHLD, Cx)	2kV

### 9.2 General Characteristics (Measured at 25°C)

Standard IQS127 devices are rated for supply voltages between 2.95V and 5V. The low voltage version of the IQS127 is rated for supply voltages between 2.0V and 5V. For supply voltages below 2.95V the device is operating below the voltage required by the internal regulator and some of the characteristics of the device may be different than those for the Standard IQS127. This low voltage device is only available for the IQS127D.

**Table 9.1 IQS127D General Operating Conditions**

DESCRIPTION	IC	Conditions	PARAMETER	MIN	TYP	MAX	UNIT
Supply voltage <sup>2</sup>	D		$V_{DDHI}$	2.95		5.50	V
Internal regulator output	D	$2.95 \leq V_{DDHI} \leq 5.0$	$V_{REG}$	2.35	2.50	2.65	V
Internal regulator output <sup>3</sup>	D	$2.0 \leq V_{DDHI} \leq 2.95$	$V_{REG}$	1.80	$V_{DDHI}$	$V_{DDHI}$	V
Boost operating current	D	$2.95 \leq V_{DDHI} \leq 5.0$	$I_{IQS127D\_BP}$		60	77	μA
Normal operating current	D	$2.95 \leq V_{DDHI} \leq 5.0$	$I_{IQS127D\_NP}$		23	29	μA
Low power operating current		$2.95 \leq V_{DDHI} \leq 5.0$	$I_{IQS127D\_LP1}$		17	22	μA
Low power operating current		$2.95 \leq V_{DDHI} \leq 5.0$	$I_{IQS127D\_LP2}$		13	17	μA
Boost operating current	D	$V_{DDHI}=2V$	$I_{IQS127D\_BP}$		50	60	μA
Low power operating current	D	$V_{DDHI}=2V$	$I_{IQS127D\_LP2}$		9	12.5	μA

**Table 9.2 IQS127S General Operating Conditions**

DESCRIPTION	IC	Conditions	PARAMETER	MIN	TYP	MAX	UNIT
Supply voltage	S		$V_{DDHI}$	4.50		5.50	V
Boost operating current	S	$V_{DDHI}=4.50V$	$I_{IQS127S\_BP}$	125			μA
Low power operating current	S	$V_{DDHI}=4.50V$	$I_{IQS127S\_LP2}$	75			μA

<sup>1</sup> See Section 9.4.1 for further details

<sup>2</sup> Applicable to standard version IQS127D

<sup>3</sup> Low voltage version of IQS127D



**Table 9.3 Start-up and shut-down slope Characteristics**

DESCRIPTION	IC	Conditions	PARAMETER	MIN	MAX	UNIT
POR	D/S	$V_{DDHI}$ Slope $\geq 100V/s$	POR	1.45	1.70	V
BOD	D/S		BOD	1.30	1.40	V

### 9.3 Output Characteristics (Measured at 25°C)

**Table 9.4 OUT and TOUT Characteristics**

Symbol	Description	$I_{SOURCE}$ (mA)	Conditions	MIN	TYP	MAX	UNIT
$V_{OH}$	Output High voltage	1	$V_{DDHI} = 5V$		4.5		V
		1	$V_{DDHI} = 3.3V$		2.97		
		1	$V_{DDHI} = 2.5V$		2.25		
Symbol	Description	$I_{SINK}$ (mA)	Conditions	MIN	TYP	MAX	UNIT
$V_{OL}$	Output Low voltage	1	$V_{DDHI} = 5V$	0.30	0.50		V
		1	$V_{DDHI} = 3.3V$	0.20	0.33		
		1	$V_{DDHI} = 2.5V$	0.20	0.25		

**Table 9.5 POUT Characteristics**

Symbol	Description	$I_{SOURCE}$ (mA)	Conditions	MIN	TYP	MAX	UNIT
$V_{OH}$	Output High voltage	5.0	$V_{DDHI} = 5V$		4.5		V
		2.5	$V_{DDHI} = 3.3V$		2.97		
		2.5	$V_{DDHI} = 2.5V$		2.25		
Symbol	Description	$I_{SINK}$ (mA)	Conditions	MIN	TYP	MAX	UNIT
$V_{OL}$	Output Low voltage	3.0	$V_{DDHI} = 5V$	0.1	0.5		V
		2.5	$V_{DDHI} = 3.3V$	0.1	0.33		
		2.5	$V_{DDHI} = 2.5V$	0.1	0.25		



## 9.4 Electromagnetic Compatibility

EMC tests conducted and classified with the following classes:

**Table 9.6 Operational level after/during test**

Class	Condition
A	Module to operate as intended during test. No degradation of performance or loss of function is allowed below a performance level specified. (Only applicable to IEC61000-4-3 and IEC61000-4-6)
B	The module shall continue to operate as intended after the test. No degradation of performance or loss of function is allowed below a performance level specified. During the test, degradation of performance is however allowed. No change of actual operating state is allowed
C	A temporary loss of function is allowed, provided the function is self recoverable or can be restored by operating the controls or by any operation specified in the instructions for use.
D	A complete malfunction and even a destruction of the electronic control is allowed but the apparatus shall not become unsafe.

### 9.4.1 Electrostatic discharge (ESD)

**Table 9.7 ESD Characteristics**

Symbol	Ratings	Conditions	Level/Class	Maximum Value	UNIT
$V_{ESD(HBM)}$	Electrostatic discharge voltage (Human body model)	$T_A = +25^\circ\text{C}$ , conforming to JESD22-A114	2	2000	V
$V_{ESD(CDM)}$	Electrostatic discharge voltage (Charge device model)	$T_A = +25^\circ\text{C}$ , conforming to JESD22-C101-D	IV	1000	V
$V_{ESD(Product)}$	Electrostatic discharge voltage (Product specification) <sup>1</sup>	$T_A = +25^\circ\text{C}$ , conforming to IEC61000-4-2, Air- discharge on Cx, SHLD	4	±8	kv
$V_{ESD(Product)}$	Electrostatic discharge voltage (Product specification) <sup>4</sup>	$T_A = +25^\circ\text{C}$ , conforming to IEC61000-4-2, Contact-discharge on Cx, SHLD	1	±1	kv
$V_{ESD(Product)}$	Electrostatic discharge voltage (Product specification) <sup>4</sup>	$T_A = +25^\circ\text{C}$ , conforming to IEC61000-4-2, Contact-discharge on $V_{DDHI}$ , $V_{SS}$	3	±6	kv

<sup>1</sup> Product specification is dependent on PCB layout



### 9.4.2 EMI (Radio frequency Interference) – IEC61000-4-3

**Table 9.8 EMI (Radio frequency Interference) – IEC61000-4-3**

Monitored frequency band (Mhz)	Immunity level (V/m)	Level/Class	Conditions
80-270	3	2/A	$V_{DDHI} = 5V, T_A = +25^{\circ}C,$ TSOT23-6
270-1000	10	3/A	
850-1000	30	4/A	
1800-1900	30	4/A	
2300-2500	30	4/A	

### 9.4.3 Static Latch-Up (LU)

**Table 9.9 Static Latch-Up (LU)**

Class	Symbol	Parameter	Conditions
A	LU	Static latch-up class	$T_A = +25^{\circ}C$ , conforming to EIA/JESD 78 IC latch-up standard

For further details on test results please request from Azoteq.



## 9.5 Timing Characteristics

**Table 9.10 Main Oscillator NP mode<sup>1</sup>**

SYMBOL	DESCRIPTION	Conditions	MIN	TYP	MAX	UNIT
F <sub>OSC</sub>	IQS127D Main oscillator	2.95 ≤ V <sub>DDHI</sub> ≤ 5.0	0.9	1	1.1	MHz
F <sub>OSC</sub>	IQS127S Main oscillator	4.5 ≤ V <sub>DDHI</sub> ≤ 5.0	0.9	1	1.1	MHz
F <sub>OSC</sub>	IQS127D Main oscillator	2.0 ≤ V <sub>DDHI</sub> ≤ 2.95	0.9	1.1	1.3	MHz

**Table 9.11 General Timing Characteristics for 2.95V ≤ V<sub>DDHI</sub> ≤ 5.0V**

SYMBOL	DESCRIPTION	Conditions	MIN	TYP	MAX	UNIT
t <sub>HIGH</sub>	Output high minimum time		9			ms
t <sub>LOW</sub>	Output low minimum time		9			ms
F <sub>CX</sub>	Charge transfer frequency			125		kHz
t <sub>LATCH</sub>	OUT high time in latch mode (active high)			4.6		sec
t <sub>CHARGE</sub>	Charge cycle duration	CS = 900		7.2		ms
t <sub>SAMPLE</sub>	Refer to section 5					ms
t <sub>BP</sub>	Sampling period in BP	t <sub>CHARGE</sub> - 2 ≤ t <sub>SAMPLE</sub>		9		ms
t <sub>BP</sub>	Sampling period in BP	t <sub>CHARGE</sub> ≥ t <sub>SAMPLE</sub>		t <sub>CHARGE</sub> +2		ms
t <sub>START</sub>	Refer to section 0		14.4	17	18.8	us
t <sub>INIT</sub>	Refer to section 0			136		us
t <sub>DATA</sub>	Refer to section 0			136		us
t <sub>NP</sub>	Sampling period in NP			50		ms
t <sub>LP1</sub>	Sampling period in LP1			100		ms
t <sub>LP2</sub>	Sampling period in LP2			200		ms
t <sub>ZOOM</sub>	Period in BP after possible event			4.6		s

**Table 9.12 IQS127 Response Times**

Power Mode	Proximity			IC Batch #
	Min	Max	Unit	
Boost Power	54	63	ms	All
Normal Power	95	145	ms	All
Low Power 1	145	245	ms	All
Low Power 2	245	445	ms	All
Power Mode	Touch			IC Batch #
	Typical		Unit	
All	250		ms	Up to 127DBD
All	120		ms	From 127DBx

<sup>1</sup> All timings are derived from the main oscillator.



## 9.6 Packaging Information

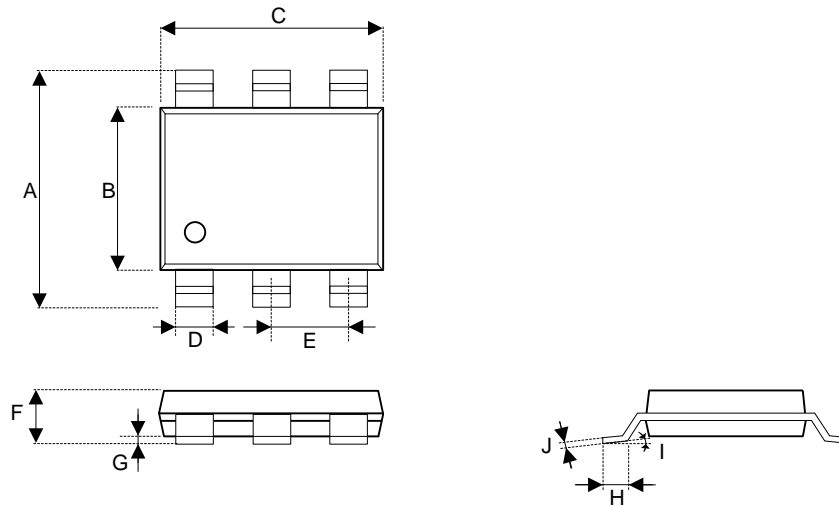

**Figure 9.1 TSOT23-6 Packaging<sup>1</sup>**

**Table 9.13 TSOT23-6 Dimensions**

Dimension	Min	Max	Tolerance
A	2.80 mm typ		Basic
B	1.60 mm typ		Basic
C	2.90 mm typ		Basic
D	0.40 mm		±0.10mm
E	0.95 mm typ		Basic
F	1.00mm		Max
G	0.05 mm		±0.05mm
H	0.40 mm		±0.10mm
I	4°		±4°
J	0.127 mm typ		+0.07/-0.007

## 9.7 Package MSL

**Moisture Sensitivity Level (MSL)** relates to the packaging and handling precautions for some semiconductors. The MSL is an electronic standard for the time period in which a moisture sensitive device can be exposed to ambient room conditions (approximately 30°C/60%RH) before reflow occur.

**Table 9-1: MSL**

Package	Level (duration)
TSOT23-6	MSL 1 (Unlimited)

<sup>1</sup> Drawing not on Scale



## 10 Datasheet and Part-number Information

### 10.1 Ordering Information

Orders will be subject to a MOQ (Minimum Order Quantity) of a full reel. Contact the official distributor for sample quantities. A list of the distributors can be found under the “Distributors” section of [www.azoteq.com](http://www.azoteq.com).

For large orders, Azoteq can provide pre-configured devices.

The Part-number can be generated by using USBProg.exe or the Interactive Part Number generator on the website.

Standard IQS127 devices are rated for  $2.95V \leq V_{DDHI} \leq 5V$ . The low voltage version of the IQS127D devices ( $2.0V \leq V_{DDHI} \leq 5V$ ) must be specifically ordered. Please contact Azoteq directly for these orders, as it will have a different MOQ and price from the standard ICs.

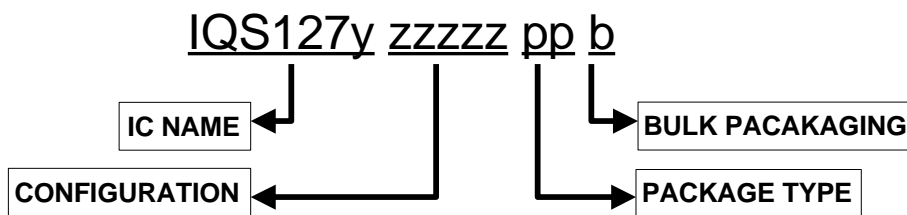

<b>IC NAME</b>	IQS127D	=	IQS127 with <b>D</b> ual outputs
	IQS127S	=	IQS127 with driven <b>S</b> hield
<b>CONFIGURATION</b>	zzzzz	=	IC Configuration (hexadecimal)
<b>PACKAGE TYPE</b>	TS	=	TSOT23-6
<b>BULK PACKAGING</b>	R	=	Reel (3000pcs/reel) – MOQ = 3000pcs

### 10.2 Standard Devices

The default (unconfigured) device will be suitable for most applications. Some popular configurations are kept in stock and do not require further programming. (Ordering codes given for Device IDs: 03 0D / 03 0E or later (the Device ID will be read in USBProg))

**Table 10.1 Standard Devices Available**

Standard Devices <sup>1</sup>	Function
IQS127S-00000TSR	Default
IQS127D-00000TSR	Default
IQS127D-00002TSR	Active HIGH outputs
IQS127D-00008TSR	Touch = toggle output mode (Light Switch mode)
IQS127D-00200TSR	Normal Power Mode

<sup>1</sup> All configurations ‘default’ except those mentioned under Function



## 10.3 Device Packaging Convention

### 10.3.1 Top

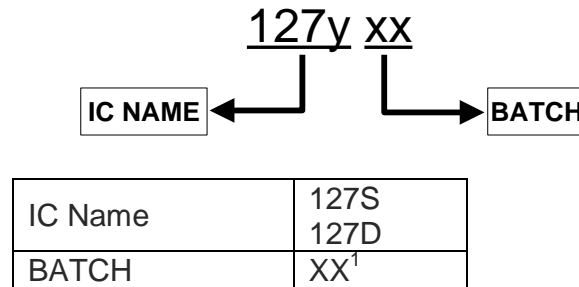

### 10.3.2 Bottom

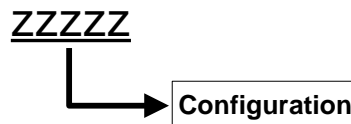

## 10.4 Datasheet Revision History

Version 1.0 – First official release

Version 1.1 – Add BOD and POR

- Correct formatting errors

- Correct minor errors

Version 1.2 – Edited version (Final Production release)

Version 1.3 – Updated current consumption

Version 1.4 – Corrected version number

- Fixed Section 10.3

Version 1.4 – Fixed bookmarks and added patents on last page

Version 1.6 – Updated power mode descriptions and Section 4

- Removed EMI test results

Version 1.7 – Updated Short and Long 1-Wire protocol data string (removed LTN)

- Removed the word 'debug' when describing the 1-wire data mode

- Added MSL data

Version 1.8 – Corrected Section 4.1

---

<sup>1</sup> Sequential alphabetical combination. Starting at BA (prod. version) following with BB, BC etc





## 11 Contact Information

### PRETORIA OFFICE

Physical Address  
160 Witch Hazel Avenue  
Hazel Court 1, 1<sup>st</sup> Floor  
Highveld Techno Park  
Centurion, Gauteng  
Republic of South Africa

Tel: +27 12 665 2880  
Fax: +27 12 665 2883

Postal Address  
PO Box 16767  
Lyttelton  
0140  
Republic of South Africa

### PAARL OFFICE

Physical Address  
109 Main Street  
Paarl  
7646  
Western Cape  
Republic of South Africa

Tel: +27 21 863 0033  
Fax: +27 21 863 1512

Postal Address  
PO Box 3534  
Paarl  
7620  
Republic of South Africa

The following patents relate to the device or usage of the device: US 6,249,089 B1, US 6,621,225 B2, US 6,650,066 B2, US 6,952,084 B2, US 6,984,900 B1, US 7,084,526 B2, US 7,084,531 B2, US 7,119,459 B2, US 7,265,494 B2, US 7,291,940 B2, US 7,329,970 B2, US 7,336,037 B2, US 7,443,101 B2, US 7,466,040 B2, US 7,498,749 B2, US 7,528,508 B2, US 7,755,219 B2, US7,772,781, US 7,781,980 B2, EP 1 120 018 B1, EP 1 206 168 B1, EP 1 308 913 B1, EP 1 530 178 B1, ZL 99 8 14357.X, AUS 761094

**IQ Switch<sup>®</sup>, ProxSense<sup>™</sup>, AirButton<sup>®</sup> and the IQ Logo are trademarks of Azoteq.**

The information appearing in this Datasheet is believed to be accurate at the time of publication. However, Azoteq assumes no responsibility arising from the use of the specifications described. The applications mentioned herein are used solely for the purpose of illustration and Azoteq makes no warranty or representation that such applications will be suitable without further modification, nor recommends the use of its products for application that may present a risk to human life due to malfunction or otherwise. Azoteq products are not authorized for use as critical components in life support devices or systems. No licenses to patents are granted, implicitly or otherwise, under any intellectual property rights. Azoteq reserves the right to alter its products without prior notification. For the most up-to-date information, please contact [ProxSenseSupport@azoteq.com](mailto:ProxSenseSupport@azoteq.com) or refer to the website.

**WWW.AZOTEQ.COM**

**ProxSenseSupport@azoteq.com**