



IQS213A Datasheet

IQSwitch® - ProxSense® Series

3-Channel Capacitive Touch/Swipe Function Controller

Overview

Unparalleled Features

- Sub 5µA* current consumption (“Zero-Power” electronic switch).
- Internal Capacitor Implementation (ICI) – Reference capacitor on-chip
- Automatic Tuning Implementation (ATI) - Automatic tuning for optimal operation in various environments & compensation against sensitivity reducing objects
- **IQS213A** advised for applications with high load-capacitances and high sensitivity requirements.

The **IQS213A** ProxSense® IC is a fully integrated two or three channel capacitive swipe function sensor with market leading sensitivity and automatic tuning of the sense electrodes. The **IQS213A** provides a minimalist implementation requiring few external components, with OTP-option settings (Stand-Alone mode) and programmable I²C-compatible interface, which allow configuration for numerous applications.

Main Features

- 2 or 3 Channel (Projected- or Self-Capacitance) Input device
- Swipe Function or Individual (Normal) Touch Electrode Implementation
- Variable User Interface with Adjustable Swipe Function Configuration
- Auto-Off and Advanced Auto-Off Warning Function
- Supply voltage: 1.8V to 3.6V
- Internal voltage regulator and reference capacitor
- Advanced on-chip digital signal processing
- OTP (One Time Programmable) options available
- Stand-Alone GPIO Output (**Default**) / I²C-compatible interface
- Low Power Modes (sub 4µA*)
- Variable Proximity & Touch Thresholds
- Small outline MSOP-10 package

Applications

- Sanitary ware, toys, office equipment
- Flashlights, headlamps, keychain lights
- Splash- / waterproof devices
- Swipe-to-Unlock / Wake from Standby applications
- Replacement for electro-mechanical switches

Advantages

- Prevents accidental activation of conventional touch sensors
- Improved digital filtering to reduce external noise
- High immunity against aqueous substances
- Highly adjustable device with continuous data or event driven I²C communication

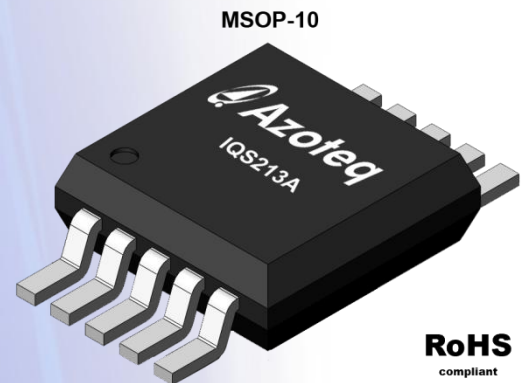

Available options

T _A	MSOP10
-20°C to 85°C	IQS213A

*Current consumption dependant on selected Low Power settings.



Contents

OVERVIEW 1

CONTENTS 2

1 FUNCTIONAL OVERVIEW 3

1.1 APPLICABILITY 3

2 ANALOGUE FUNCTIONALITY 3

3 DIGITAL FUNCTIONALITY 3

4 HARDWARE CONFIGURATION 4

4.1 IQS213A - MSOP10 PIN-OUT 4

TABLE 4.1 : IQS213A PIN-OUT 4

4.2 REFERENCE DESIGN (IQS213A, SELF-CAPACITANCE, ACTIVE-LOW OUTPUT) 5

5 USER CONFIGURABLE OPTIONS 7

5.1 CONFIGURING OF DEVICES 7

5.2 USER SELECTABLE CONFIGURATION (OTP) OPTIONS 8

TABLE 5.1 8

TABLE 5.2 9

TABLE 5.3 10

TABLE 5.4 11

TABLE 5.5 12

TABLE 5.6 13

5.3 IQS213A SETUP EXAMPLES 14

6 DESCRIPTION OF USER SELECTABLE OPTIONS. 18

6.1 IQS213A IC TYPE 18

6.2 SELF- / PROJECTED CAPACITANCE 18

6.3 FLOAT RX 19

6.4 OUTPUT LOGIC SELECT 19

6.5 HALT TIME 20

6.6 LOW POWER MODES 20

TABLE 6.1 : LOW POWER MODE TIMING (T_{LP}) 21

6.7 PROXIMITY THRESHOLD 21

6.8 TOUCH THRESHOLDS 21

6.9 IQS213A SWIPE UI 22

6.10 ZERO STATES ALLOWED 22

6.11 END ON ZERO STATE 22

6.12 STATE TIMES 22

6.13 TOUCH/SWIPE (PIN7) OUTPUT 23

6.14 AC FILTER 23

6.15 ATI METHOD 23

6.16 BASE VALUE 23

6.17 ATI TARGET VALUE 23

6.18 AUTO-OFF / ADVANCED AUTO-OFF WARNING 24

6.19 I²C DEBUG 24

7 ADDITIONAL FEATURES 24

7.1 NOISE DETECTION 24

8 PROXSENSE® MODULE 26

8.1 CHARGE TRANSFER CONCEPTS 26

8.2 PROXSENSE® MODULE SETUP 26

8.3 SELF- OR PROJECTED CAPACITANCE 26

8.4 RATE OF CHARGE CYCLES 27

8.5 TOUCH REPORT RATE 27

8.6 ACTIVE CHANNELS 27

8.7 LONG TERM AVERAGE (LTA) 28

8.8 DETERMINE TOUCH OR PROX 28

8.9 ATI 28

8.10 RF DETECTION 29

9 COMMUNICATION 30

9.1 EVENT MODE 30

9.2 I²C SPECIFIC COMMANDS 30

9.3 I²C READ AND WRITE SPECIFICS 30

10 IQS213A MEMORY MAP 31

10.1 MEMORY REGISTERS 31

TABLE 10.1 : IQS213A MEMORY REGISTERS 31

TABLE 10.2 : IQS213A MEMORY REGISTER BITS 33

10.2 MEMORY REGISTERS DESCRIPTION 33

11 ELECTRICAL SPECIFICATIONS – ALL PRELIMINARY 41

11.1 ABSOLUTE MAXIMUM SPECIFICATIONS 41

11.2 GENERAL CHARACTERISTICS (MEASURED AT 25°C) 41

TABLE 11.1 IQS213A GENERAL OPERATING CONDITIONS (A) 41

TABLE 11.2 IQS213A CURRENT CONSUMPTION (B) 42

TABLE 11.3 IQS213A CURRENT CONSUMPTION (C) 42

TABLE 11.4 IQS213A CURRENT CONSUMPTION (D) 42

TABLE 11.5 START-UP AND SHUT-DOWN SLOPE CHARACTERISTICS 43

TABLE 11.6 DEBOUNCE EMPLOYED ON IQS213A 43

11.3 TIMING CHARACTERISTICS 43

TABLE 11.7 MAIN OSCILLATOR¹ 43

TABLE 11.8 GENERAL TIMING CHARACTERISTICS FOR 1.80V ≤ V_{DDHI} ≤ 3.60V 43

TABLE 11.9 IQS213A CHARGING TIMES 43

12 PACKAGING INFORMATION 44

MSOP-10 PCB FOOTPRINT DIMENSIONS: 44

12.1 TAPE AND REEL SPECIFICATION 45

12.2 PACKAGE MSL 45

TABLE 12.1 MSOP-10 MSL CLASSIFICATION 45

13 DEVICE MARKING 46

13.1 TOP MARKING 46

13.2 BOTTOM MARKING 46

14 ORDERING INFORMATION 47

14.1 GENERAL PART ORDER NUMBER 47

15 CONTACT INFORMATION 48



1 Functional Overview

The **IQS213A** is a two or three channel capacitive proximity and touch sensor with variable swipe function configurations. Additional features include internal voltage regulation and reference capacitor (C_S), which enables cost efficient and minimal component designs. The device offers flexible design approaches by allowing the connection of two or three sense antennas in either surface or projected capacitance configurations.

For swipe function applications the device has a single logic output to indicate swipe actions and one complementary output for consecutive swipe/touch activities. The device can also be configured to operate with individual touch outputs, with an additional proximity output when implementing surface capacitance sense electrodes.

Full control by a master device is achieved by configuring the logic outputs in a serial data (I^2C) communication option on TO0 (SCL), TO1 (SDA) and TO2 (RDY).

Note: Programming of OTP's required to enable I^2C operation.

The device automatically tracks slow varying environmental changes via various filters, detects noise and has an Automatic Tuning Implementation (**ATI**) to tune the device for optimal sensitivity.

1.1 Applicability

All specifications, except where specifically mentioned otherwise, provided by this datasheet are applicable to the following ranges:

- Temperature: $-20^{\circ}C$ to $+85^{\circ}C$
- Supply voltage (V_{DDHI}): 1.8V to 3.6V

2 Analogue Functionality

For self-capacitance configured sense electrodes the analogue circuitry measures the capacitance of the sense antennas

attached to the C_X pins through a charge transfer process that is periodically initiated by the digital circuitry. For projected-capacitance configurations the capacitance is measured between the transmit (TX) and receive (CRX) pins. The measuring process is referred to as a conversion and consists of the discharging of C_S and C_X , the charging of C_X and then a series of charge transfers from C_X to C_S until a trip voltage is reached. The number of charge transfers required to reach the trip voltage is referred to as the Count (CS) Value.

The capacitance measurement circuitry makes use of an internal C_S and voltage reference (V_{REG}).

The analogue circuitry further provides functionality for:

- Power on reset (POR) detection.
- Brown out detection (BOD).

3 Digital Functionality

The digital processing functionality is responsible for:

- Device setup from OTP settings after POR.
- Management of BOD and WDT events.
- Initiation of conversions at the selected rate.
- Processing of CS and execution of algorithms.
- Monitoring and automatic execution of the ATI algorithm.
- Signal processing and digital filtering.
- Detection of PROX and TOUCH events.
- Managing outputs of the device.
- Managing serial communications.
- Manage programming of OTP options.

4 Hardware Configuration

4.1 IQS213A - MSOP10 Pin-Out

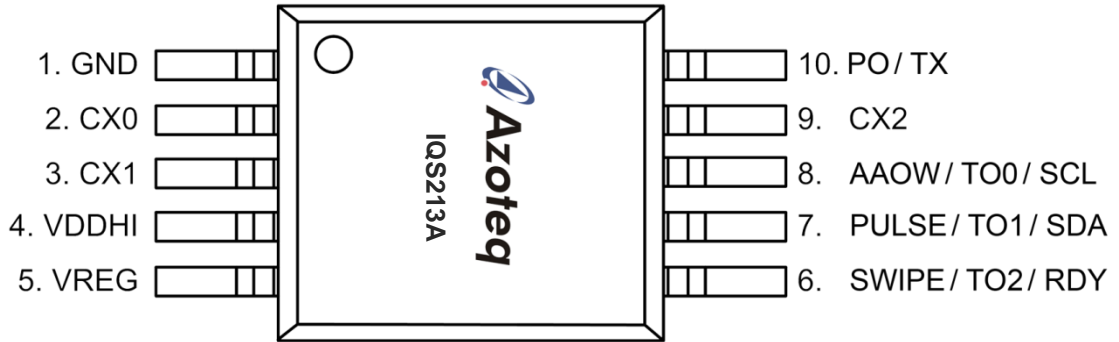

Figure 4.1 : Pin-out of IQS213A MSOP-10 package

Table 4.1 : IQS213A Pin-out

IQS213A Pin-out			
Pin	Name	Type	Function
1	GND	Supply Input	Ground Reference
2	CX0 (CRX0)	Analogue	Sense Electrode 0
3	CX1 (CRX1)	Analogue	Sense Electrode 1
4	VDDHI	Supply Input	Supply Voltage Input
5	VREG	Analogue Output	Internal Regulator Pin (Connect 1µF bypass capacitor)
6	SWIPE/TO2/RDY	Digital Output	Swipe Output/Touch Output/I ² C: RDY Output
7	PULSE/T01/SDA	Digital Output	Pulse Output/Touch Output/I ² C: SDA Output
8	AAOW/TO0/SCL	Digital I/O	Auto-Off Warning/Touch Output/I ² C: SCL Input
9	CX2 (CRX2)	Analogue	Sense Electrode 2
10	PO/TX	Digital Output / Transmitter	Proximity Output/ Projected Sense Electrode



4.2 Reference Design (IQS213A, Self-Capacitance, Active-Low Output)

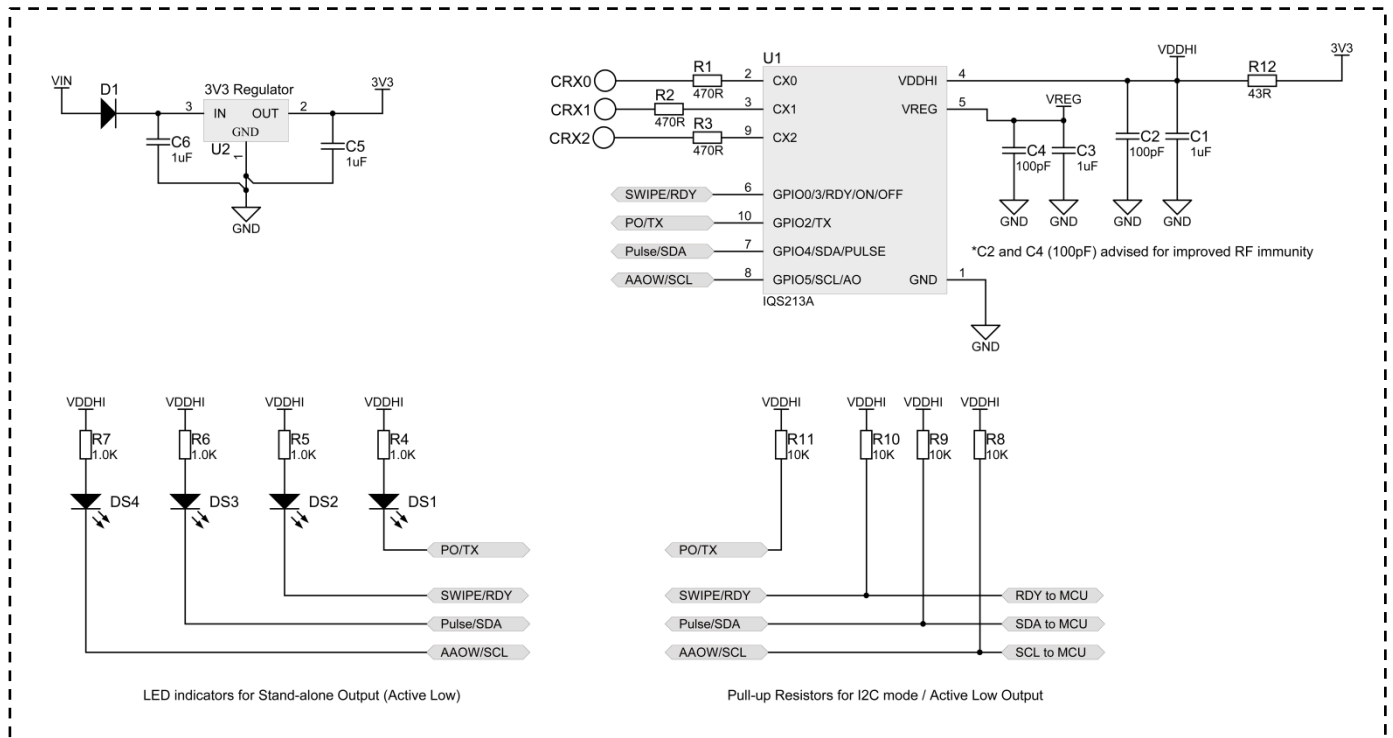

Figure 4.2 : IQS213A Reference Design (Self-Capacitance, Active-Low)

Note: For Active-Low configurations the external pull-up resistors (i.e. R8-R10) must be populated for correct functioning of the relevant Open-Drain (SW-OD) outputs. Resistor R11 should only be placed for a “Self-Capacitive” system when using the Active-Low (SW-OD) proximity output (pin10).

R12: Place a 43Ω resistor in series with the VDDHI supply line to prevent a potential ESD induced latch-up state. Maximum supply current should be limited to 80mA on the **IQS213A** VDDHI pin to prevent latch-up.

4.2.2 Power Supply and PCB Layout

Azoteq IC's provide a high level of on-chip hardware and software noise filtering and ESD protection (refer to application note “**AZD013 – ESD Overview**”). Designing PCB's with better noise immunity against EMI, FTB and ESD in mind, it is always advisable to keep the critical noise suppression components like the de-coupling capacitors and series resistors in **Figure 4.2** as close as possible to the IC. Always maintain a good ground connection and ground pour underneath the IC.

For more guidelines please refer to the relevant application notes as mentioned in **Section 4.2.3**.

4.2.3 Design Rules for Harsh EMC Environments

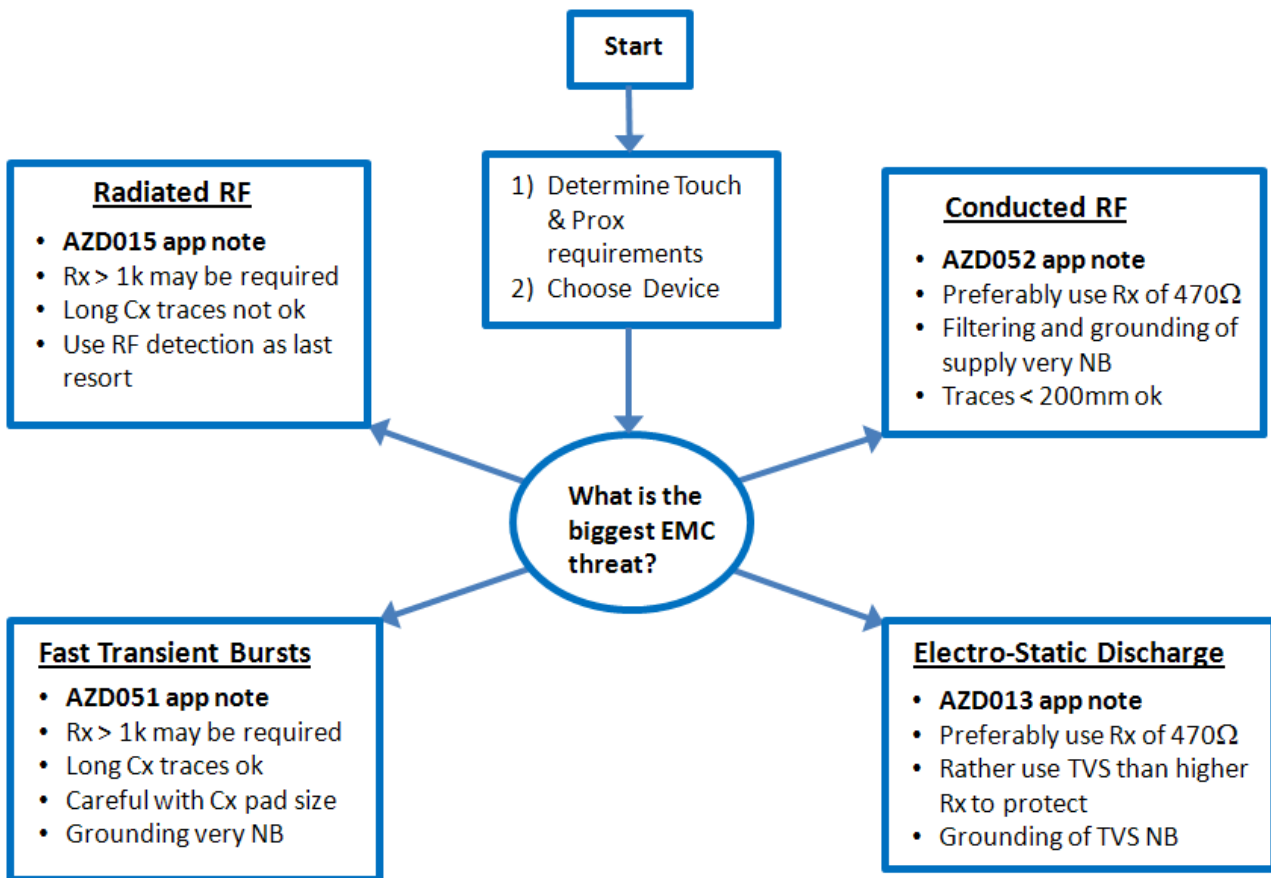

Figure 4.3 : EMC Design Rules

➤ **Applicable application notes: AZD013, AZD015, AZD051, AZD052.**

4.2.4 High Sensitivity

Through patented design and advanced signal processing, the device is able to provide extremely high sensitivity to detect proximity. This enables designs to detect proximity at distances that cannot be equaled by most other products. When the device is used in environments where high levels of noise exist, a reduced proximity threshold is proposed to ensure reliable functioning of the sensor.

When the capacitance between the sense antenna and ground becomes too large the sensitivity of the device may be influenced. For more guidelines on layout, please refer to application note **AZD008**, available on the Azoteq web page: www.azoteq.com.



5 User Configurable Options

The **IQS213A** provides **One Time Programmable (OTP)** user options, which can be programmed to change the device's default start-up configuration. Blank/Un-programmed devices has a default OTP configuration = 00000000 (See **Section 5.2** for OTP options).

With the use of Azoteq's IQS213A GUI software, the **IQS213A** can enter streaming mode in a start-up state (*Test Mode*) where the OTP options can be configured and evaluated, before selecting OTP's for programming.

NOTE: I²C-communication is NOT ENABLED by Default, and the device will be in a Stand-Alone mode configuration with GPIO outputs. To enable I²C-communication, the **I²C-debug** option in OTP bank 4 has to be programmed.

The configuration of the device can be done on packaged devices or in-circuit. In-circuit configuration may be limited by the type and/or values of external components chosen.

Please see **Section 5.3** for **IQS213A** device setup and output configuration examples.

5.1 Configuring of Devices

Azoteq offers a Configuration Tool (CT210 or later) and associated software (USBProg.exe) that can be used to program the OTP user options for prototyping purposes. More details regarding the configuration of the device with the USBProg program can be found in "**AZD007 - USBProg Overview**" available on the Azoteq website.

For further enquiries regarding this subject, please contact your local distributor or submit enquiries to Azoteq at: ProxSenseSupport@azoteq.com



5.2 User Selectable Configuration (OTP) Options

Table 5.1 : User Selectable Configuration (OTP) Options : Bank 0

bit7	Bank 0						bit0
THALT1	THALT0	LOGIC	FLOAT RX	PROJ	IC TYPE2	IC TYPE1	IC TYPE0

Bank0: bit7:6	THALT1:THALT0: LTA Halt Time	Section 6.5
	00 = 2.5s 01 = 20s 10 = 60s 11 = Never	
Bank0: bit5	LOGIC: Output Logic	Section 6.4
	0 = Active Low ¹ 1 = Active High	
Bank0: bit4	FLOAT RX: Float Sense Electrodes	Section 6.8
	0 = No 1 = Yes	
Bank0: bit3	PROJ: Capacitive Technology	Section 6.2
	0 = Self Capacitance 1 = Projected Capacitance	
Bank0: bit2:0	IC TYPE: Select IC type	Section 6.1
	000 = 1zz 12z z2z - 2CH SWIPE 001 = 1zz x2x zz3 - 3CH SWIPE (Thresholds * 2) 010 = 1zz z2z zz3 - 3CH SWIPE 011 = 1zz 12z z2z z23 zz3 - 3CH SWIPE 100 = 2CH Normal - 2 Channel Touch Sensor 101 = 3CH Normal - 3 Channel Touch Sensor 110 = 1zz 1xz x2x zx3 zz3 - 3CH SWIPE 111 = 1zz, x2x, zz3 - 3CH SWIPE	

¹ Active Low configurations are software open-drain (**SW OD**).

Note: The proximity output on the PO/TX-pin (pin 10) is multiplexed with the transmit signal (TX) for projected capacitance electrodes, and is Active High ONLY for Projected configurations.



Table 5.2 : User Selectable Configuration (OTP) Options : Bank 1

bit7	Bank 1						bit0
CH2 TTH1	CH2 TTH0	CH1, CH3 TTH1	CH1, CH3 TTH0	TTH ALT	PTH DIV	LP1	LP0

Bank1: bit7:6	CH2 TTH1:CH2 TTH0: Channel 2 Touch Threshold	Section 6.8										
	<table style="width: 100%; border-collapse: collapse;"> <tr> <td style="width: 50%;"><i>TTH ALT = 0</i></td> <td style="width: 50%;"><i>TTH ALT = 1</i></td> </tr> <tr> <td>00 = 4</td> <td>00 = 22</td> </tr> <tr> <td>01 = 8</td> <td>01 = 28</td> </tr> <tr> <td>10 = 12</td> <td>10 = 36</td> </tr> <tr> <td>11 = 16</td> <td>11 = 48</td> </tr> </table>	<i>TTH ALT = 0</i>	<i>TTH ALT = 1</i>	00 = 4	00 = 22	01 = 8	01 = 28	10 = 12	10 = 36	11 = 16	11 = 48	
<i>TTH ALT = 0</i>	<i>TTH ALT = 1</i>											
00 = 4	00 = 22											
01 = 8	01 = 28											
10 = 12	10 = 36											
11 = 16	11 = 48											
Bank1: bit5:bit4	CH1, CH3 TTH: Ch 1 & Ch 3 Touch Threshold	Section 6.8										
	<table style="width: 100%; border-collapse: collapse;"> <tr> <td style="width: 50%;"><i>TTH ALT = 0</i></td> <td style="width: 50%;"><i>TTH ALT = 1</i></td> </tr> <tr> <td>00 = 4</td> <td>00 = 22</td> </tr> <tr> <td>01 = 8</td> <td>01 = 28</td> </tr> <tr> <td>10 = 12</td> <td>10 = 36</td> </tr> <tr> <td>11 = 16</td> <td>11 = 48</td> </tr> </table>	<i>TTH ALT = 0</i>	<i>TTH ALT = 1</i>	00 = 4	00 = 22	01 = 8	01 = 28	10 = 12	10 = 36	11 = 16	11 = 48	
<i>TTH ALT = 0</i>	<i>TTH ALT = 1</i>											
00 = 4	00 = 22											
01 = 8	01 = 28											
10 = 12	10 = 36											
11 = 16	11 = 48											
Bank1: bit3	TTH ALT: Alternative Touch Thresholds	Section 6.8										
	0 = No 1 = Yes											
Bank1: bit2	PTH: Proximity Threshold Selection	Section 6.7										
	0 = 3 Counts 1 = 8 Counts											
Bank1: bit1:0	LP1:LP0: Low Power Selection	Section 6.6										
	<table style="width: 100%; border-collapse: collapse;"> <tr> <td style="width: 50%;">00 = NP</td> <td style="width: 50%;">- Normal Power</td> </tr> <tr> <td>01 = 128ms</td> <td>- Low Power Mode 1</td> </tr> <tr> <td>10 = 256ms</td> <td>- Low Power Mode 2</td> </tr> <tr> <td>11 = 512ms</td> <td>- Low Power Mode 3</td> </tr> </table>	00 = NP	- Normal Power	01 = 128ms	- Low Power Mode 1	10 = 256ms	- Low Power Mode 2	11 = 512ms	- Low Power Mode 3			
00 = NP	- Normal Power											
01 = 128ms	- Low Power Mode 1											
10 = 256ms	- Low Power Mode 2											
11 = 512ms	- Low Power Mode 3											



Table 5.3 : User Selectable Configuration (OTP) Options : Bank 2

bit7	Bank 2: SWIPE IC						bit0
ACF	Pin7_OUT	CHG_FRQ	Min_State	Zero_End	Zero_State	SWIPE UI1	SWIPE UI0

Bank2: bit7	ACF: AC Filter Selection	Section 6.14
	0 = Disabled 1 = Enabled	
Bank2: bit6	Pin7_OUT: SWIPE IC Pin 7 Output Selection	Section 6.13
	0 = Touch 1 = Pulse	
Bank2: bit5	CHG_FRQ: Charge Transfer Frequency	Section 8.3
	0 = 0.5MHz / 1.0MHz (Self - / Projected Capacitance) 1 = 1.0MHz / 2.0 MHz (Self - / Projected Capacitance)	
Bank2: bit4	Min_State: Minimum State Time	Section 6.12
	0 = 1 Sample 1 = 2 Samples	
Bank2: bit3	Zero_End: End Swipe on Zero State (zzz)	Section 6.11
	0 = Disabled 1 = Enabled	
Bank2: bit 2	Zero_State: Allow Zero States In Swipe Sequence	Section 6.10
	0 = Disabled 1 = Enabled	
Bank2: bit 1:bit0	SWIPE UI1: SWIPE UI0: Swipe UI Selection	Section 6.9
	00 = Single Direction 01 = Bi-Directional 10 = Directional 11 = Dual Swipe	



Table 5.4 : User Selectable Configuration (OTP) Options : Bank 2

bit7	Bank 2: Normal Touch IC						bit0
ACF		CHG_FRQ			Toggle CH3	Toggle CH2	Toggle CH1

Bank2: bit7	ACF: AC Filter Selection	Section 6.14
	0 = Disabled 1 = Enabled	
Bank2: bit6		
Bank2: bit5	CHG_FRQ: Charge Transfer Frequency	Section 8.3
	0 = 0.5MHz / 1.0MHz (Self - / Projected Capacitance) 1 = 1.0MHz / 2.0 MHz (Self - / Projected Capacitance)	
Bank2: bit4		
Bank2: bit3		
Bank2: bit 2	Toggle CH3: Channel 3 Touch Output = Toggle	
	0 = Disabled 1 = Enabled	
Bank2: bit 1	Toggle CH2: Channel 2 Touch Output = Toggle	
	0 = Disabled 1 = Enabled	
Bank2: bit 0	Toggle CH1: Channel 1 Touch Output = Toggle	
	0 = Disabled 1 = Enabled	



Table 5.5 : User Selectable Configuration (OTP) Options : Bank 3

bit7	Bank 3						bit0
				AAO_CLR	AAO	ATI_Target	ATI_Base

Bank3: bit7	System Use					
Bank3: bit6	System Use					
Bank3: bit5	System Use					
Bank3: bit4	System Use					
Bank3: bit3	AAO_CLR: Clear Auto-Off Timer On Event					Section 6.18
	0 = Touch Event 1 = Proximity Event					
Bank3: bit 2	AAO: Advanced Auto-Off Function Selection					Section 6.18
	0 = Enabled 1 = Disabled					
Bank3: bit 1	ATI_Target: ATI Target Value					Section 6.17
		<i>Proximity</i>	<i>Touch</i>			
	0 =	320	160			
	1 =	640	320			
Bank3: bit 0	ATI_Base: ATI Base Value (All Channels)					Section 6.16
	0 = 75 1 = 100					



Table 5.6 : User Selectable Configuration (OTP) Options : Bank 4

bit7	Bank 4						bit0
				I ² C Debug			

Bank4: bit7	System Use
Bank4: bit6	System Use
Bank4: bit5	System Use
Bank4: bit4	System Use
Bank4: bit3	I²C Debug: I²C Interface (Default = Event-Mode) Section 6.19 0 = Disabled 1 = Enabled
Bank4: bit 2	System Use
Bank4: bit 1	System Use
Bank4: bit 0	System Use



5.3 IQS213A Setup Examples

5.3.1 Example 1: 3-Channel Self Capacitive, Active Low Logic Output, SwipeSwitch with Auxiliary Touch Output.

Example 1 (see **Figure 5.1**) illustrates the user interface (UI) and device outputs for a **3-Channel Self Capacitive SwipeSwitch** (output on pin 6), in an active low configuration with the Directional UI and Auxiliary Touch Output on pin 7.

5.3.1.1 Selected User Configuration Options (Example 1):

bit7	Bank 0						bit0
THALT1	THALT0	LOGIC	FLOAT RX	PROJ	IC TYPE2	IC TYPE1	IC TYPE0
0	0	0	N/A	0	*	*	*

*** The IC TYPE can be any 3-Channel SwipeSwitch™ option, e.g. 001,110 or 111.

THALT1:0 = 00 – 2.5s Halt time selected for this example.

bit7	Bank 1						bit0
CH2 TTH1	CH2 TTH0	CH1, CH3 TTH1	CH1, CH3 TTH0	TTH ALT	PTH DIV	LP1	LP0
N/A	N/A	N/A	N/A	N/A	N/A	N/A	N/A

bit7	Bank 2: SWIPE IC						bit0
ACF	Pin7_OUT	CHG_FRQ	Min_State	Zero_End	Zero_State	SWIPE UI1	SWIPE UI0
N/A	0	N/A	N/A	N/A	N/A	1	0

bit7	Bank 4						bit0
				I ² C Debug			
				0			

5.3.1.2 Device outputs (Directional SwipeSwitch™ UI)

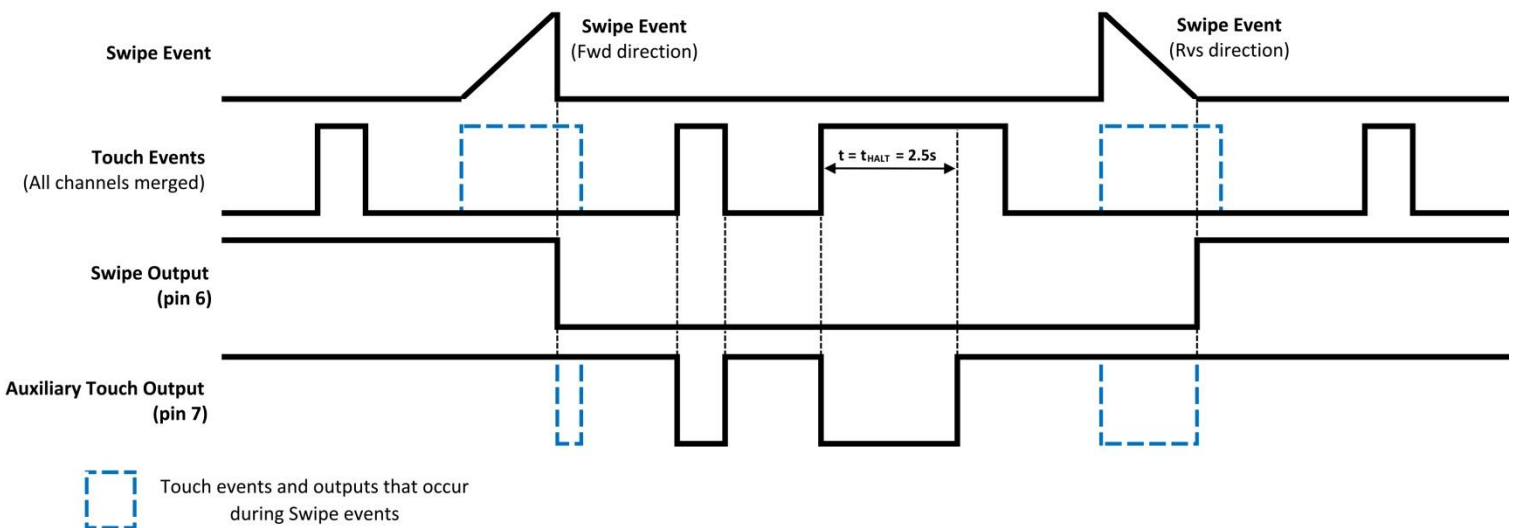

Figure 5.1 : IQS213A setup example 1



5.3.2 Example 2: 3-Channel Projected Capacitive, Active High Logic Output, SwipeSwitch with Auxiliary Swipe Pulse Output.

Example 2 (see **Figure 5.2**) illustrates the user interface (UI) and device outputs for a **3-Channel Projected Capacitive SwipeSwitch** (output on pin 6), in an active high configuration with the Bi-Directional UI and Auxiliary **Swipe Pulse** Output on pin 7.

5.3.2.1 Selected User Configuration Options (Example 2):

bit7	Bank 0						bit0
THALT1	THALT0	LOGIC	FLOAT RX	PROJ	IC TYPE2	IC TYPE1	IC TYPE0
N/A	N/A	1	N/A	1	*	*	*

*** The IC TYPE can be any 3-Channel SwipeSwitch option, e.g. 001,110 or 111.

bit7	Bank 1						bit0
CH2 TTH1	CH2 TTH0	CH1, CH3 TTH1	CH1, CH3 TTH0	TTH ALT	PTH DIV	LP1	LP0
N/A	N/A	N/A	N/A	N/A	N/A	N/A	N/A

bit7	Bank 2: SWIPE IC						bit0
ACF	Pin7_OUT	CHG_FRQ	Min_State	Zero_End	Zero_State	SWIPE UI1	SWIPE UI0
N/A	1	N/A	N/A	N/A	N/A	0	1

Pin7_OUT = 1 : The output on pin 7 will be a pulse signal *(within a 2-second window), of which the pulse length depends on the direction of the swipe event. See Section 6.13.

*The 2-second window is reset after each swipe event.

bit7	Bank 4						bit0
				I ² C Debug			
				0			

5.3.2.2 Device outputs (Bi-Directional SwipeSwitch UI)

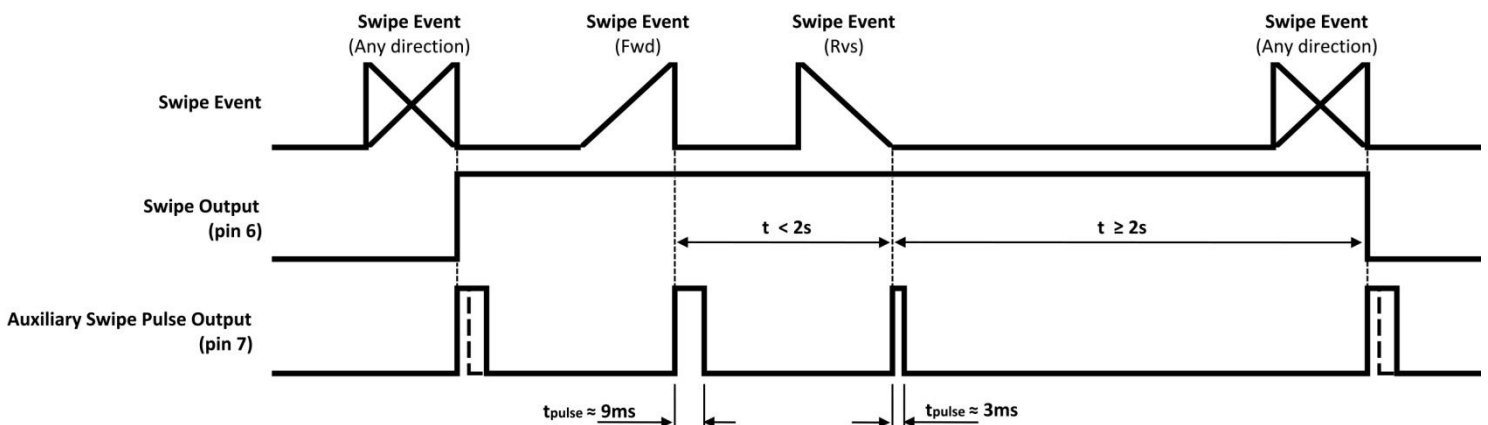

Figure 5.2 : IQS213A Setup example 2



5.3.3 Example 3: Normal Mode Operation

Example 3 illustrates the user interface (UI) and device outputs for a **2- or 3-Channel Normal Mode (TOUCH) Device**, with optional toggle state outputs. Note that the lower three bits of Bank2 are reserved for Toggle options, when the IC TYPE is selected in a Normal Mode configuration. The Normal Mode (i.e Touch) device can be either Self- or Projected Capacitive with either Active High or Active Low (Logic) outputs.

5.3.3.1 Example 3.1: 2-Channel Normal Mode – No Toggle Active, Active Low Logic

bit7	Bank 0						bit0
THALT1	THALT0	LOGIC	FLOAT RX	PROJ	IC TYPE2	IC TYPE1	IC TYPE0
N/A	N/A	0	N/A	N/A	1	0	0

bit7	Bank 2: Normal Touch IC						bit0
ACF		CHG_FRQ			Toggle CH3	Toggle CH2	Toggle CH1
N/A		N/A			0	0	0

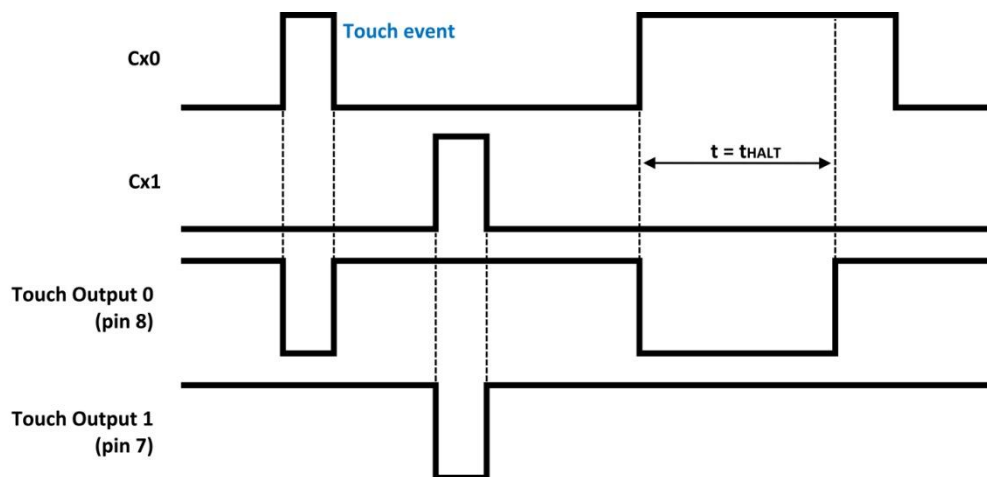

Figure 5.3 : IQS213A Setup example 3.1



5.3.3.2 Example 3.2: 3-Channel Normal Mode – All Toggles Active, Active High Logic

bit7	Bank 0						bit0
THALT1	THALT0	LOGIC	FLOAT RX	PROJ	IC TYPE2	IC TYPE1	IC TYPE0
N/A	N/A	1	N/A	N/A	1	0	1

bit7	Bank 2: Normal Touch IC						bit0
ACF		CHG_FRQ			Toggle CH3	Toggle CH2	Toggle CH1
N/A		N/A			1	1	1

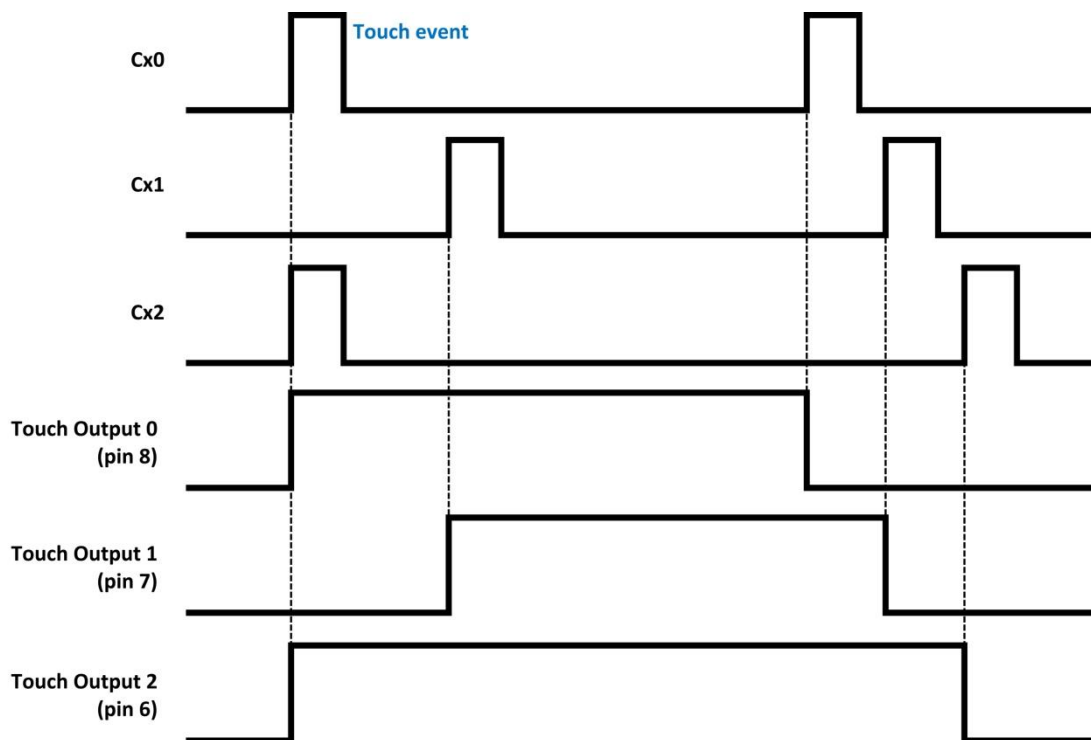

Figure 5.4 : IQS213A Setup example 3.2



6 Description of User Selectable Options

This section briefly describes the individual user programmable options of the **IQS213A**, with additional information and detailed descriptions being provided in **Section 8**.

Thresholds and other settings can also be evaluated in Test Mode streaming without programming the OTP options. For the appropriate software, please visit: www.azoteq.com

6.1 IQS213A IC Type

The **IQS213A** has six selectable Swipe-Switch™ setup configurations, allowing the user maximum freedom in the design of the intended application. The device type configuration specifies the required user input, which is identified by a sequence of a combination of input states, where a *[number]* (e.g. 1, 2 or 3) indicates a touch condition/state on that specific channel, a *[z-character]* indicates a zero condition/state and a *[x-character]* indicates a “don't care” condition/state (i.e. a number or zero condition is acceptable). The input states related to sequences accepting x-character conditions are also referred to as relaxed states.

- **2CH SWIPE - 1zz 12z z2z** :
2-Channel swipe switch operation.
- **3CH SWIPE – 1zz x2x zz3 (TH*2)** :
3-Channel swipe switch operation.
- **3CH SWIPE - 1zz z2z zz3** :
3-Channel swipe switch operation.
- **3CH SWIPE - 1zz 12z z2z z23 zz3** :
3-Channel swipe switch operation.
- **3CH SWIPE - 1zz 1xz x2x zx3 zz3** :
3-Channel swipe with relaxed states.
- **3CH SWIPE - 1zz x2x zz3** :
3-Channel swipe with relaxed states.

The **IQS213A** also has 2 selectable normal setup configurations, which allows the user to implement standard touch and proximity sensing features.

- **2CH Normal Mode** :
2-Channel Normal Touch operation.
- **3CH Normal Mode** :
3-Channel Normal Touch operation.

With the device setup in either 2-channel or 3-channel Normal Mode, touch events corresponding to the different sense electrodes will be output on TO0 (pin 8), TO1 (pin 7) and TO2 (pin 6), with a proximity output available on PO (pin 10).

During Normal Mode operation, setting the different “Toggle_CHx” bits in Bank 2, will enable the touch output signals to toggle.

6.2 Self- / Projected Capacitance

Enabling the projected capacitance option, will cause the measurement of the sense electrode capacitance between the transmit (TX) and receive (CRX) pins.

The proximity output on the PO/TX-pin (pin 10) is multiplexed with the transmit signal (TX) for projected capacitance electrodes, and is Active High ONLY for such configurations.

The implementation of a projected capacitance sense electrode will result in a higher charge frequency (i.e. $f_{cm} = 1\text{MHz}$) compared to that of a self capacitance configuration (i.e. $f_{cs} = 500\text{kHz}$). Setting bit5 in Bank2 will double the charge frequency for both projected- and self capacitance configurations (i.e. $f_{cm} / f_{cs} = 2\text{MHz} / 1\text{MHz}$).

A higher charge frequency selection is preferred for increased immunity against aqueous substances when used in most projected capacitance configurations.

6.2.1 Capacitive Sense Electrode Design Samples

6.2.1.1 Self Capacitance Electrodes

2-Channel Self Capacitance Electrode



3-Channel Self Capacitance Electrode



Figure 6.1 : Self Capacitance Swipe Switch Sample Electrodes.

6.2.1.2 Projected Capacitance Electrodes

2-Channel Projected Capacitance Electrode

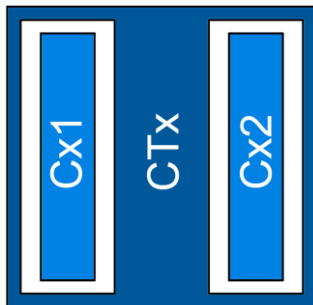

3-Channel Projected Capacitance Electrode

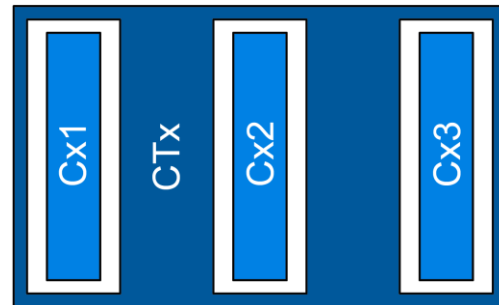

Figure 6.2 : Projected Capacitance Swipe Switch Sample Electrodes.

6.3 Float Rx

During the charge transfer process (see **Figure 8.1**) the channels that are not being processed during the current cycle, is effectively grounded to decrease the effects of noise-coupling between the sense electrodes. Selecting the "Float RX" option (Bank0 bit4), will thus result in the non-current channels to float (i.e. not grounded) during the charge cycle of the current channel.

6.4 Output Logic Select

The **IQS213A** can be set to sink or source current in stand-alone mode (I²C Debug = Disabled), by setting the logic output Active High (Push-Pull) or Active Low (SW OD).

For Active Low operation, the device output pins are set in a software open-drain (SW OD) configuration, which requires the use of external pull-up resistors on the output pins.

The proximity output on the PO/TX-pin (pin 10) is multiplexed with the transmit signal (TX) for projected capacitance electrodes, and is Active High ONLY for Projected configurations. Thus for self capacitance



configurations, the proximity output on PO (pin10) depends on the selected output logic

(Bank0 bit5).

6.5 Halt Time

The Halt Timer is started when a proximity or touch event occurs and is restarted when that event is removed or reoccurs. When a proximity condition occurs on any of the channels, the LTA (Long-Term Average) value for that channel will be "halted", thus its value will be kept fixed, until the proximity event is cleared, or the halt timer reaches the halt time. The halt timer will count to the selected halt time (t_{HALT}), which can be configured in the user selectable options (i.e.

Bank0 bit7:6), and if the timer expires, all outputs will be cleared.

It is possible that the CS (Count) value could be outside the ATI band (ATI Target \pm 12.5%) when the timer expires, which will cause the device to perform a re-ATI event.

The designer needs to select a halt timer value (t_{HALT}) to best accommodate the required application:

- **2.5 seconds** : Halt LTA for 2.5 seconds after the last proximity or touch event.
- **20 seconds** : Halt LTA for 20 seconds after the last proximity or touch event.
- **60 seconds** : Halt LTA for 60 seconds after the last proximity or touch event.
- **Never** : Never halt LTA

* *With the 'Never' option, the detection of a proximity or touch event will not halt the LTA and the LTA will adjust towards the CS value until the CS value is reached. The touch and proximity output of a channel will thus be cleared automatically when the difference between the LTA and CS is less than the specified threshold value.*

6.6 Low Power Modes

The IQS213A IC has three low power modes specifically designed to reduce current consumption for battery applications.

The power modes are implemented around the occurrence of a charge cycle every t_{SAMPLE} seconds (refer to **Table 6.1**). Lower sampling frequencies typically yield significant lower power consumption (but also decreases the response time).

During normal operation charge cycles are initiated approximately every 2.6ms in the stand-alone setup and 3.9ms in the I²C debug setup. This is referred to as Normal Power Mode (NP). The IQS213A by default charges in Normal Power Mode.

While in any low power mode, only Channel 0 is active and the device will zoom to NP whenever the CS value indicates a possible proximity or touch event on CH0 (refer to **Figure 6.3**). This improves the response time. The device will remain in NP for t_{ZOOM} seconds and then return to the selected low power mode. The Zoom function allows reliable detection of events with the current samples being produced at the NP rate. Please see **Section 8.4** or refer to **"Application Note AZD079 – IQS213 Touch response rate"** for more information.

Table 6.1 : Low Power Mode Timing (t_{LP})

Power Mode	t_{SAMPLE} (Stand-alone)	t_{SAMPLE} (I ² C)
NP (Default)	2.6 ms	3.9ms
LP1	128 ms	128ms
LP2	256 ms	256ms
LP3	512 ms	512ms

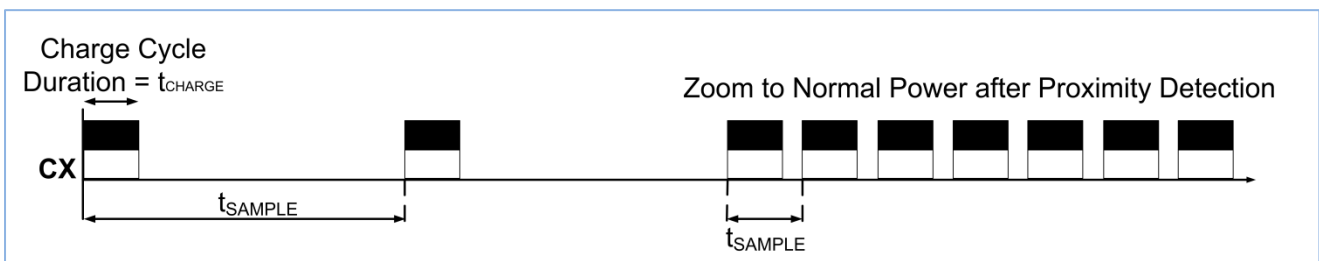

Figure 6.3 : LP Modes – Charge Cycles

6.7 Proximity Threshold

The **IQS213A** has 2 proximity threshold (P_{TH}) settings. The proximity threshold is selected by the designer to obtain the desired sensitivity and noise immunity. The proximity event is triggered based on the selected proximity threshold, which is either 3 or 8 counts.

The proximity threshold is expressed in terms of counts, the same as the CS value.

For proximity events, the difference between the LTA and CS (in counts) of the proximity channel should be greater than P_{TH} for at least 4 consecutive samples, unless the CS delta is greater than the touch threshold of any active channel. (See **Section 8.8**)

6.8 Touch Thresholds

The **IQS213A** has 8 touch threshold settings. The touch threshold is selected by the designer to obtain the desired touch sensitivity.

The touch event is triggered based on the selected touch threshold, which is expressed as a fraction of the LTA, given by:

$$T_{TH} = x/255 \times LTA. \text{ (See Section 8.8)}$$

For a touch event, the difference between LTA and CS (counts) of the touch channel should be greater than the selected touch threshold for at least 2 consecutive samples.

On the **IQS213A** device, the touch threshold settings are grouped for channels 1 and 3 ($CH_{1,3} T_{TH}$) and is separate for channel 2 ($CH_2 T_{TH}$).

The **IQS213A** device is by default setup without the alternative threshold settings. The alternative threshold values can be selected by setting the TTH_ALT bit (i.e. bit3 in Bank1).

If for specific applications the designer requires larger touch threshold values than the available selections, they may select the “3CH SWIPE – 1zz x2x zz3 (TH*2)” IC TYPE in Bank0 of the user configurable options.



This selection is for a three channel sense electrode configuration only and will automatically multiply the threshold selections by two.

6.9 IQS213A SWIPE UI

The **IQS213A** has 4 selectable swipe switch user interface (UI) configurations. The swipe UI specifies the required event(s) to activate the outputs of the device:

- **Single Direction:**

The device only acknowledges swipe events in the direction of **CH1>CH2** for a 2-channel and **CH1>CH2>CH3** for a 3-channel device setup.

- **Bi-Directional:**

The device acknowledges swipe events in both the forward (**CH1>CH2>...**) and reverse (**...>CH2>CH1**) directions.

- **Directional:**

A swipe event in the forward (**CH1>CH2>...**) direction will enable the swipe output (ON) and a swipe in the reverse (**...>CH2>CH1**) direction will disable the output (OFF).

- **Dual Swipe:**

This UI requires a swipe event in one direction, followed by a swipe event in the opposite direction within 1 second, to enable the swipe output (ON). Thereafter, a single swipe in any direction will subsequently disable the swipe output again (OFF).

6.10 Zero States Allowed

Setting the **Zero_State** bit in Bank2, will allow the occurrence of zero or "no touch" conditions between the different state combinations in

each sequence of the selected IC type (refer to **Section 6.1** for IC types).

This grants the designer a certain degree of freedom in the selected device sensitivity and implemented sense electrode.

If for example the IC type is selected to be "**3CH SWIPE - 1zz z2z zz3**", then the sequence '**1zz zzz z2z zzz zz3**' of state combinations will also be acknowledged as a valid swipe event.

6.11 End on Zero State

Setting the **Zero_End** bit in Bank2, will append an additional zero or "no touch" state to the required sequence of state combinations.

If for example the IC type is selected to be "**3CH SWIPE - 1zz z2z zz3**", then the sequence '**1zz z2z zz3 zzz**' of state combinations will be acknowledged as a valid swipe event ONLY.

6.12 State Times

The minimum, maximum and overall swipe state times controls the effective period during which a successful swipe event can be recognized. The state times are defined in swipe state samples, where each sample period t_{STATE} is equal to 4 charge transfer periods. For stand-alone device operation this results in a state sample time of approximately $t_{STATE} = 10.4ms$.

The state time values can also be set up or changed in I²C debug mode.

6.12.1 Minimum State Time

The minimum state time (t_{MIN}) defines the minimum period (in multiples of t_{STATE}) for which each combination of states (e.g. 1zz) must be present during processing of the current sequence of the state combination. Selecting shorter minimum state times will effectively allow faster swipe events.



6.12.2 Maximum State Time

The maximum state time defines the maximum period for which each combination of states (e.g. 1zz) may be present during processing of the current sequence of the state combination.

This value is fixed at $t_{MAX} = 45 * t_{STATE}$ by default, but is accessible in I²C debug mode. Selecting longer maximum state times will effectively allow slower swipe events.

6.12.3 Overall State Time

The overall state time is the total allowable time for performing a swipe event and is by default set to 1 second. This value can also be changed in I²C debug mode in steps of 250ms.

6.13 Touch/Swipe (Pin7) Output

The IQS213A has one complementary output on pin 7 of the IC. This pin can be configured to output either touch events or pulses upon swipe events, after the swipe output (pin 6) has been enabled.

By default the IQS213A will output a logic signal for touch events on any of the three sense electrodes. If the **Pin7_Out** bit in Bank2 is set, the device will output a short pulse for every consecutive swipe event within 2 seconds after the first swipe event.

The generated pulses have different pulse widths (t_{PULSE}), depending on the direction of the swipe event:

- **Long Pulse:** A long pulse ($t_{PULSE} \approx 9ms$) will be output for swipes in the forward (**CH1>CH2...**) direction.
- **Short Pulse:** A short pulse ($t_{PULSE} \approx 3ms$) will be output for swipes in the reverse (**...>CH2>CH1**) direction.

6.14 AC Filter

The AC filter can be implemented to provide better stability of the proximity channel's count (CS) measurements in electrically noisy environments by setting the **ACF** bit in Bank2.

The AC filter also enforces a longer minimum sample time for detecting proximity events, which may result in a slower response rate when the device enters low power modes.

6.15 ATI Method

In the stand-alone configuration the IQS213A is automatically set up in Full ATI to set up the device for optimal sensitivity.

In the I²C debug configuration, the IQS213A can be set up to start in two ways, Full ATI and Partial ATI. In Full ATI mode, the device automatically selects the multipliers through the ATI algorithm to setup the IQS213A as close as possible to its default sensitivity for the environment where it was placed. The designer can, however, select Partial ATI, and set the multipliers to a pre configured value. This will cause the IQS213A to only calculate the compensation (not the compensation and multipliers as in Full ATI), which allows the freedom to make the IQS213A more or less sensitive for its intended environment of use. (Please refer to **Section 8.9**.)

6.16 Base Value

The IQS213A has the option to change the base value of all channels during the ATI algorithm. Depending on the application, this provides the user with another option to select the sensitivity of the IQS213A without changes in the hardware (CX sizes and routing, etc). By setting the **ATI_Base** bit in Bank3, the base value can be set to be 75 or 100. A lower base value will typically result in a higher sensitivity of the device. (Refer to **Section 8.9**)

6.17 ATI Target Value

The default target counts of the IQS213A are 320 for the proximity channel, and 160 for the touch channels.

However, for some applications, a more sensitive device and higher target is required.



Therefore, the **ATI_Target** bit in Bank3 can be set, changing the targets to 640 for the proximity channel, and 320 for the touch channels. (See **Section 8.9**)

6.18 Auto-Off / Advanced Auto-Off Warning

To prevent battery drainage in the unlikely event of a false activation of the output load, the **IQS213A** is equipped with an Auto-Off functionality. The Auto-Off (AAO) feature can be disabled by setting the **AAO** bit in Bank3.

6.18.1 Advanced Auto-Off Warning (AAOW)

In stand-alone operation the Advanced Auto-Off Warning (AAOW) timer is set for 10 minutes. After the first warning, a second warning will be given after 30s. Another 30s after the second warning, the device will switch off automatically (i.e. disable all outputs).

In I²C operation the Auto-Off (AAO) and Advanced Auto-Off Warning (AAOW) timers can be set to any value in multiples of 30s.

6.18.2 AAOW Clear / Reset

The AAO timer is by default cleared (reset) on a touch event on any channel. Setting the **AAO_CLR** bit in Bank3, the AAO timer will be reset upon a proximity event.

6.19 I²C Debug

A streaming option is available that allows for serial data communication on the **IQS213A**. Data streaming is done via an I²C compatible 3-wire interface, which consist of a data (**SDA**), clock (**SCL**) and ready (**RDY**) line (for **IQS213A** pin-out refer to **Figure 4.1**).

The **IQS213A** can only function as a slave device on the bus, and will only acknowledge on address **0x44H**.

The RDY line is to be used by the host controller as an indication of when to start communication to the device. The RDY line will

be active low when it is ready for communication, and it will go high when it is doing conversions. The **IQS213A** will not acknowledge (ACK) on its address while the RDY line is high (i.e. while the **IQS213A** is doing conversions).

7 Additional Features

7.1 Noise Detection

The **IQS213A** has advanced integrated immunity to RF noise sources such as GSM cellular telephones, DECT, Bluetooth and WIFI devices. Design guidelines should however be followed to ensure the best noise immunity. (Please see **Section 8.10**)

7.1.1 Notes for layout:

- A ground plane should be placed under the IC, except under the CX lines.
- Place the sensor IC as close as possible to the sense electrodes.
- All the tracks on the PCB must be kept as short as possible.
- The capacitor between VDDHI and GND as well as between VREG and GND must be placed as close as possible to the IC.
- A 100pF capacitor can be placed in parallel with the 1uF capacitor between VDDHI and GND. Another 100pF capacitor can be placed in parallel with the 1uF capacitor between VREG and GND.
- When the device is too sensitive for a specific application a parasitic capacitor (max 5pF) can be added between the CX line and ground.
- Proper sense antenna and button design principles must be followed.
- Unintentional coupling of sense antenna to ground and other circuitry must be limited by increasing the distance to these sources.



-
- In some instances a ground plane some distance from the device and sense antenna may provide significant shielding from undesirable interference.
 - * However, if after proper layout, interference from an RF noise source persists, see application note **AZD015**.



8 ProxSense® Module

The **IQS213A** contains a ProxSense® module that uses patented technology to provide detection of PROX/TOUCH on numerous sensing lines.

The ProxSense® module is a combination of hardware and software, based on the principles of charge transfer measurements.

For I²C communication related data registers, please refer to the **IQS213A** Memory Map in **Section 10**.

8.1 Charge Transfer Concepts

Capacitance measurements are taken with a charge transfer process that is periodically initiated.

Self capacitance sensing measures the capacitance between the sense electrode (Cx) relative to ground.

Projected capacitance sensing measures the capacitance between 2 electrodes referred to as the transmitter (CTX) and receiver (CRX).

The measuring process is referred to as a charge transfer cycle and consists of the following:

- Discharging of an internal sampling capacitor (Cs) and the antenna capacitors (self: Cx or projected: CTX & CRx) on a channel.
- charging of Cx's / CTX's connected to the channel
- and then a series of charge transfers from the Cx's / CRX's to the internal sampling capacitors (Cs), until the trip voltage is reached.

The number of charge transfers required to reach the trip voltage on a channel is referred to as the Count or CS value.

The device continuously repeats charge transfers on the sense electrodes connected to the Cx pin. For each channel a Long Term Average (**LTA**) is calculated (12 bit unsigned

integer values). The CS values (12 bit unsigned integer values) are processed and compared to the LTA to detect Touch and Proximity events.

For more information regarding capacitive sensing, refer to the application note: "**AZD004 – Azoteq Capacitive Sensing**".

Please note: Attaching scope probes to the Cx/CTX/CRX pins will influence the capacitance of the sense electrodes and therefore the related CS values of those channels. This will have an instant effect on the CS measurements.

8.2 ProxSense® Module Setup

The **IQS213A** samples its channels in 4 time slots, with one internal Cs capacitor. The charge sequence is illustrated in **Fig. 8.1**.

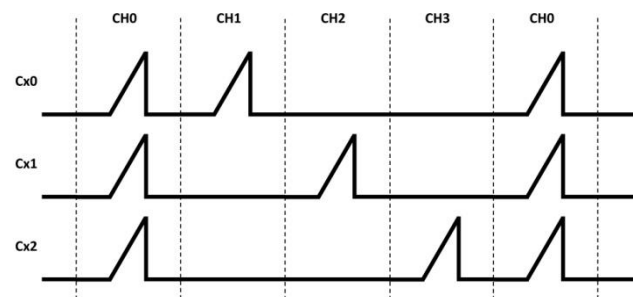

Figure 8.1 IQS213(A) Charge Transfers

The **IQS213A** charges its four channels, **CH0** (Distributed Proximity Channel) and three Touch Channels (**CH1**, **CH2** and **CH3**) independently during the four time slots. During these time slots, the non-current channels can either be grounded or set to float.

8.3 Self- or Projected Capacitance

The **IQS213A** IC can be used in either self- or projected capacitance configurations. The IC is default in a 2-channel self capacitance setup. This can be changed to a projected capacitance configuration in the user selectable options (Bank0 bit3). The



technology enabled on the IC will be reported in the SYSFLAGS register.

The **IQS213A** has two selectable charge transfer frequencies. For projected capacitance sense electrodes the charge frequency is by default set at $f_{cm} = 1\text{MHz}$, and for self capacitance configurations $f_{cs} = 500\text{kHz}$. Setting the **CHG_FRQ** bit in Bank2 will double the charge frequency for both projected- and self capacitance configurations (i.e. $f_{cm} / f_{cs} = 2\text{MHz} / 1\text{MHz}$).

A higher charge frequency selection is preferred for increased immunity against aqueous substances when used in most projected capacitance electrode configurations.

8.4 Rate of Charge Cycles

8.4.1 Normal Power rate

With the **IQS213A** in Normal Power (NP) mode, the sense channels are charged at a fixed sampling frequency (f_{SAMPLE}) per channel. This is done to ensure regular samples for processing of results. It is calculated as each sample having a time ($t_{\text{SAMPLE}} = \text{charge period} (t_{\text{CHARGE}}) + \text{computation time}$) of approximately 2.6ms, thus the time between consecutive samples on a channel (t_{CHANNEL}) will optimally be $t_{\text{SAMPLE}} = 4 * t_{\text{SAMPLE}} \approx 10.4\text{ms}$ (or 96Hz). The charge sequence and timings are illustrated in **Figure 8.2**.

If a channel is thus disabled, the sampling rate on the remaining channels will reduce with approximately 2.6ms.

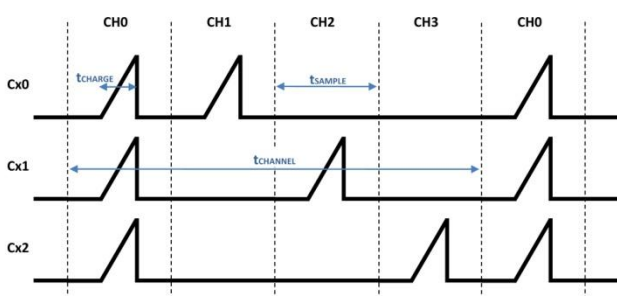

Figure 8.2 Signals on CX's / CRX's during Normal Power Mode.

8.4.2 Low Power rates

Low current consumption charging modes are available. In any Low Power (LP) mode, there will be an applicable low power time (t_{LP}). This is determined by the LP_PERIOD register. The value written into this register multiplied by 16ms will yield the LP time (t_{LP}).

Please note that this time is only applicable from value 03h and higher loaded into the LP_PERIOD register. The values 01h and 02h will have a different time. See **Table 6.1** for all timings.

With the detection of an undebounced proximity event the IC will zoom to NP mode, allowing a very fast reaction time for further possible touch / proximity events. All active channels will be consecutively charged every T_{LP} .

If a LP rate is selected through register LP_Period and charging is not in the zoomed in state (NP mode), the LP_Active bit (SYSFLAGS register) will be set.

8.5 Touch Report Rate

During Normal Mode operation, the touch report rate of the **IQS213A** device depends on the charge transfer frequency, the number of channels enabled and the length of communications performed by the master device.

8.6 Active channels

The user has the option to enable the third channel (CH3) during I²C operation. This can be done in the SWIPE_SETTINGS register (SET_3CH bit). Only two channels (CH1 and CH2) are default enabled.

Note: During Low Power (LP) modes only CH0 is active.



8.7 Long Term Average (LTA)

The LTA filter can be seen as the baseline or reference value. The LTA is calculated to continuously adapt to any environmental drift. The LTA filter is calculated from the CS value for each channel. The LTA filter allows the device to adapt to environmental (slow moving) changes/drift. Actuation (Touch or Prox) decisions are made by comparing the CS value with the LTA reference value.

The 12bit LTA value is contained in the LTA_H and LTA_L registers.

Please refer to Section 6.5 for LTA Halt Times.

8.8 Determine Touch or Prox

An event is determined by comparing the CS with the LTA. Since the CS reacts differently when comparing the self- with the projected capacitance technology, the user should consider only the conditions for the technology used.

An event is recorded if:

- Self: CS < LTA – **Threshold**
- Projected: CS > LTA + **Threshold**

Threshold can be either a Proximity or Touch threshold, depending on the current channel being processed.

Please refer to **Section 6.7** and **6.8** for proximity and touch threshold selections.

8.9 ATI

The **Automatic Tuning Implementation (ATI)** is a sophisticated technology implemented on the new ProxSense® series devices. It allows for optimal performance of the devices for a wide range of sense electrode capacitances, without modification or addition of external components.

The ATI allows the tuning of two parameters, an ATI Multiplier and an ATI Compensation, to

adjust the sample value for an attached sensing antenna.

ATI allows the designer to optimize a specific design by adjusting the sensitivity and stability of each channel through the adjustment of the ATI parameters.

The **IQS213A** has an automated ATI function. The auto-ATI function is default enabled, but can be disabled by setting the ATI_OFF and ATI_Partial bits in the PROX_SETTINGS registers.

The ATI_Busy bit in the SYSFLAGS register will be set while an ATI event is busy.

8.9.1 ATI Sensitivity

In I²C mode, the designer can specify the global BASE value for all channels and the TARGET values for the proximity (CH0) and touch (CH1,CH2,CH3) channels. A rough estimation of sensitivity can be calculated as:

$$Sensitivity = \frac{TARGET}{BASE}$$

As can be seen from this equation, the sensitivity can be increased by either increasing the Target value or decreasing the Base value. It should, however, be noted that a higher sensitivity will yield a higher noise susceptibility.

8.9.2 ATI Target

The target is reached by adjusting the COMPENSATION bits for each channel.

The target value is written into the respective channel's TARGET registers. The value written into these registers multiplied by 8 will yield the new target value.

8.9.3 ATI Base (MULTIPLIER)

The following parameters will influence the base value:

- CS_SIZEⁱ: Size of sampling capacitor.

ⁱ Changing CS_SIZE if ATI_OFF = 0 will change CS



- PROJ_BIAS bits: Adjusts the biasing of some analogue parameters in the projected capacitive operated IC. (Only applicable in projected capacitance mode.)
- MULTIPLIER bits.

The base value used for the ATI function can be implemented in 2 ways:

1. ATI_PARTIAL = 0. ATI automatically adjusts MULTIPLIER bits to reach a selected base valueⁱⁱ. Base values are available in the BASE_VALUE register.
2. ATI_PARTIAL = 1. The designer can specify the multiplier settings. These settings will give a custom base value from where the compensation bits will be automatically implemented to reach the required target value.

8.9.4 Re-ATI

An automatic re-ATI event will occur if the CS is outside its re-ATI limits. The re-ATI limit is calculated as the target value divided by 8. For example:

Target = 320

Re-ATI will occur if CS is outside 320±40.

During I²C operation, a re-ATI event can also be issued by the master by setting the REDO_ATI bit. It will clear automatically after the ATI event was started.

8.10 RF Detection

In cases of extreme RF interference, the on-chip RF detection is suggested. This detector can be enabled by setting the Noise_Detect bit in the PROX_SETTINGS1 register. By connecting a suitable antenna to the RF pin, it allows the device to detect RF noise and notify the master of possible corrupt data.

Noise affected samples are not allowed to influence the LTA filter, and also do not contribute to proximity or touch detection. With the detection of noise, the NOISE_FOUND bit in SYSFLAGS will be set.

8.10.1 RF detector sensitivity

The sensitivity of the RF detector can be selected by setting an appropriate RF detection voltage through the RF_TRIM bits. Please see application note **AZD015** for further details regarding this option.

ⁱⁱ ATI function will use user selected CS_SIZE and PROJ_BIAS (if applicable) and will only adjust the MULTIPLIER bits to reach the base values.



9 Communication

The **IQS213A** can communicate on the I²C compatible bus structure. It uses a 3-wire serial interface bus which is I²C compatible and comprise of a data (**SDA**), clock (**SCL**) and optional ready (**RDY**) line (for **IQS213A** pin-out refer to **Figure 4.1**).

The **IQS213A** has one available I²C address, **I²C address = 0x44H**.

The maximum I²C compatible communication speed for the **IQS213A** is 400kbit/s.

9.1 Event Mode

The **IQS213A** will by default be configured to only communicate with the master if a change in an event occurs. For this reason, it would be highly recommended to use the RDY line when communicating with the **IQS213A**, especially in Low Power (LP) modes. These communication requests are referred to as Event Mode triggering (only changes in events are reported).

Event mode can be disabled by setting the **EVENT_MODE_OFF** bit.

The events responsible for resuming communication can be chosen through the **EVENT_MASK** register. By default all events are enabled.

The device can also communicate on polling basis, using only the SDA and SCL lines.

9.2 I²C Specific commands

9.2.1 IC Reset indication

SHOW_RESET can be read to determine whether a reset occurred on the device. This bit will be a '1' after a reset. The value of **SHOW_RESET** can be cleared to '0' by writing a '1' in the **ACK_RESET** bit.

9.2.2 WDT

The WDT is used to reset the IC if a problem (for example a voltage spike) occurs during communication. The WDT will time-out after t_{WDT} , if no valid communication occurs for this time.

9.3 I²C Read and Write specifics

For more details, please refer to the **IQS213A** Memory Map (**Section 10**) for device memory register descriptions and application note: "**AZD066: IQS213 Communication Interface Guideline**" document available at: www.azoteq.com.



10 IQS213A Memory Map

10.1 Memory Registers

Table 10.1 : IQS213A Memory Registers

Register Address	Register Name	Description	
00H	Product Number	'D43' / '2BH'	Device Information
01H	Version Number	'02'	
10H	Sys_flags0	System Flags - See Table 10.2	Device Specific Data
11H	Swipe Flags	Swipe Switch Flags - See Table 10.2	
35H	Touch CHs	Channels Touched - See Table 10.2	Count Data
3DH	Chan_num	Number of Currently Processed Channel	
42H	CS High	Count (CS) value [high byte]	
43H	CS Low	Count (CS) value [low byte]	
83H	LTA High	Long Term Average [high byte]	
84H	LTA Low	Long Term Average [low byte]	
C4H	Current Sate	Swipe Engine Current State	
C5H	Measured State	Current Measured State (Acc. to Touches)	
C6H	Next State	Swipe Engine Next Expected State	
C7H	Swipe States	Combination of States Required for Swipe	
C8H	Swipe Min Timer	Minimum timer counts – swipe periods	
C9H	Swipe Max Timer	Maximum Overall timer – 250ms periods	
CAH	Swipe Max State Timer	Maximum Per State timer – swipe periods	
CBH	Swipe Settings	IQS213 Set Up - See Table 10.2	
CCH	Prox Settings 0	IQS213 Set Up - See Table 10.2	Device Settings
CDH	Prox Settings 1	IQS213 Set Up - See Table 10.2	
CEH	Prox Settings 2	IQS213 Set Up - See Table 10.2	
CFH	ATI Target CH0	(Target CH0) *8 = Channel 0 Target Value	
D0H	ATI Target CH1-CH3	(Target CH1-CH3) *8 = Channel 1-3 Target Value	
D1H	Prox Threshold	Proximity Threshold Value (In Counts)	
D2H	Touch Threshold 1	Channel 1 Touch Threshold [In Counts]	



Register Address	Register Name	Description	
D3H	Touch Threshold 2	Channel 2 Touch Threshold [In Counts]	Device Settings
D4H	Touch Threshold 3	Channel 3 Touch Threshold [In Counts]	
D5H	Base Value	ATI Base Value [0-256 - In Counts]	
D6H	Event Mask	Events Allowed - See Table 10.2	
D7H	Mirror_CH0	Mirror – lower 6 bits – NN PPP	
D8H	Mirror_CH1	Mirror – lower 6 bits – NN PPP	
D9H	Mirror_CH2	Mirror – lower 6 bits – NN PPP	
DAH	Mirror_CH3	Mirror – lower 6 bits – NN PPP	
DBH	PCC0	CH0 Compensation	
DCH	PCC1	CH1 Compensation	
DDH	PCC2	CH2 Compensation	
DEH	PCC3	CH3 Compensation	
DFH	AAOW Timer	(AAOW Timer)*30s = Auto-Off Warning time	Device Settings
E0H	AO Timer	(AO Timer)*30s = Auto-Off time	
E1H	Swipe Min Samples	Set minimum samples per state [x+1]	
E2H	Swipe Max Samples	Set maximum samples per state [x+1]	
E3H	Swipe Overall Limit	Set Overall Swipe Length Limit [*250ms]	
E4H	LP Period	(LP Period)*16ms = Low Power Charge Timing (t_{LP})	
E5H	Touch States 0	Swipe Engine Configuration	
E6H	Touch States 1	Swipe Engine Configuration	
E7H	Touch States 2	Swipe Engine Configuration	
E8H	Touch States 3	Swipe Engine Configuration	
E9H	Touch States 4	Swipe Engine Configuration	
EAH	Touch States 5	Swipe Engine Configuration	
EBH	Touch States6	Swipe Engine Configuration	
ECH	Touch States 7	Swipe Engine Configuration	
EDH	Default Comms	Default Comms pointer	



Table 10.2 : IQS213A Memory Register bits

	bit7	bit6	bit5	bit4	bit3	bit2	bit1	bit0
Prox Settings 0	Show Reset	ACK Reset	Reseed	Redo ATI	ATI Partial	Float CX	THALT1	THALT0
Prox Settings 1	Comms WDT OFF	Event Mode OFF	Debug I2C	AO Clear Prox	AO OFF	ACF OFF	ATI OFF	Noise Detect OFF
Prox Settings 2					IO_OUT	CS_Cap	Proj_B1	Proj_B0
Swipe Settings	Set_3CH	Touches/Pulses	Swipe UI	Swipe UI	End_Zero	Zero_State	States Relaxed	Swipe Active
Swipe Flags	Swipe Pulse Flag	Time Out Flag	Slide Occurred	DualSwipe Active	Swipe Direction	AO Triggered	Final State	Start State
Event Mask				Noise Event	ATI Event	Swipe Event	Touch Event	Prox Event
Sys_flags0	System Use	LP Active	Active High	Projected CapSense	Filter Halt	ATI Busy	Noise Found	Zoom
Touch CHs	Swipe Output				CH3	CH2	CH1	CH0/Prox

10.2 Memory Registers Description

10.2.1 Device Information

00H		Product Number (Prod_NR)							
Access	Bit	7	6	5	4	3	2	1	0
R	Value	43 (Decimal)							

01H		Version Number (Ver_NR)							
Access	Bit	7	6	5	4	3	2	1	0
R	Value	Ver_NR							

- **[00H] PROD_NR :** The product number for the IQS213A is 43 (decimal).
- **[01H] VER_NR :** Device ROM software version number can be read in this byte.



10.2.2 Device Specific Data

10H		System Flags (Sys_flags0)							
Access	Bit	7	6	5	4	3	2	1	0
R	Name	System Use	LP Active	Active High	Projected CapSense	Filter Halt	ATI Busy	Noise Found	Zoom

- **[10H] Sys_flags0:**
 - bit7: System Use
 - bit6: LP Active – Indicates if device is in a Low Power Mode.
 - bit5: Active High – Bit is set if Output Logic is Active High.
 - bit4: Projected CapSense – Bit is set if Projected Capacitance technology is used.
 - bit3: Filter Halt – Indicates if LTA filters are halted.
 - bit2: ATI Busy – Indicates if ATI algorithm is being performed.
 - bit1: Noise Found – Bit is set if RF noise is detected. (RF Detection must be enabled)
 - bit0: Zoom – Indicates if device is zoomed to Normal Power.

11H		Swipe Switch Flags (Swipe Flags)							
Access	Bit	7	6	5	4	3	2	1	0
R/W	Name	Swipe Pulse Flag	Time Out Flag	Slide Occurred	DualSwipe Active	Swipe Direction	AO Triggered	Final State	Start State

- **[11H] Swipe Flags:**
 - bit7: Swipe Pulse Flag – Bit is set if Pin7 Output = Pulses
 - bit6: Time Out Flag – Bit is set if Max State Timer is exceeded.
 - bit5: Slide Occurred – Bit is set if Swipe event has occurred.
(Note: Bit must be cleared manually)
 - bit4: DualSwipe Active – Bit is set if Swipe UI = Dual Swipe.
 - bit3: Swipe Direction – 0 = Forward direction, 1 = Reverse direction.
 - bit2: AO Triggered – Bit is set if Auto-Off Warning has been set.
 - bit1: Final State – Bit is set if Swipe Engine is in Final State.
 - bit0: Start State – Bit is set if Swipe Engine is in Start State.



10.2.3 Current Sample (CS) or Count Data

35H		Touch/Output Data (Touch CHs)							
Access	Bit	7	6	5	4	3	2	1	0
R	Name	Swipe Output				CH3	CH2	CH1	CH0/Prox

- **[35H] Touch CHs:**
 - bit7: Swipe Output – Bit is toggled on Swipe Events. (**Note:** This bit corresponds to the IC swipe output (Pin6) and is UI dependent.)
 - bit6: Not used.
 - bit5: Not used.
 - bit4: Not used.
 - bit3: CH3 – Bit is set if a Touch is present on this channel.
 - bit2: CH2 – Bit is set if a Touch is present on this channel.
 - bit1: CH1 – Bit is set if a Touch is present on this channel.
 - bit0: CH0/Prox – Bit is set if a Proximity Event is present.

3DH		Channel Number (Chan_num)							
Access	Bit	7	6	5	4	3	2	1	0
R	Name	Variable: Value between 0x00 and 0x03							

- **[3DH] Chan_num:** bit7:0: The Chan_Num byte indicates which channel’s data is currently available in the CS and LTA bytes:
 - 0 = Ch0 (Distributed PROX channel)
 - 1 = Ch1 (CRX0)
 - 2 = Ch2 (CRX1)
 - 3 = Ch3 (CRX2)



42H		Count (CS) Value High byte (CS High)							
Access	Bit	7	6	5	4	3	2	1	0
R	Value	Variable (High byte)							

- **[42H] CS High:** bit7:0: Count (CS) Value High Byte of currently processed channel. (See Channel Number.)

43H		Count (CS) Value Low byte (CS Low)							
Access	Bit	7	6	5	4	3	2	1	0
R	Value	Variable (Low byte)							

- **[43H] CS Low:** bit7:0: Count (CS) Value Low Byte of currently processed channel. (See Channel Number.)

83H		Long Term Average High byte (LTA High)							
Access	Bit	7	6	5	4	3	2	1	0
R	Value	Variable (High byte)							

- **[83H] LTA High:** bit7:0: Long Term Average (LTA) value High Byte of currently processed channel. (See Channel Number.)

84H		Long Term Average Low byte (LTA Low)							
Access	Bit	7	6	5	4	3	2	1	0
R	Value	Variable (Low byte)							

- **[84H] LTA Low:** bit7:0: Long Term Average (LTA) value Low Byte of currently processed channel. (See Channel Number.)



10.2.4 Device Settings

CBH		SwipeSwitch Settings (Swipe Settings)							
Access	Bit	7	6	5	4	3	2	1	0
R/W	Name	Set_3CH	Touches/Pulses	Swipe UI1	Swipe UI0	End_Zero	Zero_State	States Relaxed	Swipe Active

▪ **[CBH] Swipe Settings:**

- bit7: Set_3CH – R/W bit. Set bit to enable 3rd channel (CRX2).
- bit6: Touches/Pulses – Bit indicates/set output on IC pin 7.
- bit5:4: Swipe UI – Bits indicate/set selected swipe user interface (UI).
- bit3: End_Zero – R/W bit. (See **Section 6.11**)
- bit2: Zero_State – R/W bit. (See **Section 6.10**)
- bit1: States Relaxed – R/W bit. (See **Section 6.1**)
- bit0: Swipe Active – Bit indicates/set selection of Swipe/Normal Mode IC TYPE. (See **Section 6.1**)

CCH		ProxSense® Module Settings 0 (Prox Settings 0)							
Access	Bit	7	6	5	4	3	2	1	0
R/W	Name	Show Reset	ACK Reset	Reseed	Redo ATI	ATI Partial	Float CX	THALT1	THALT0

▪ **[CCH] Prox Settings 0:**

- bit7: Show Reset – Bit is set if device was reset.
- bit6: ACK Reset – Set bit to acknowledge device reset (Setting this bit will clear Show Reset bit).
- bit5: Reseed – Set bit to reseed LTA filter values.
- bit4: Redo ATI – Set bit to perform ATI algorithm.
- bit3: ATI Partial – R/W bit. (See **Section 8.9**)
- bit2: Float CX – R/W bit. (See **Section 6.3**)
- bit1:0: THALT1:THALT0 – Bits indicate/set LTA halt period. (See **Section 6.5**)



CDH		ProxSense® Module Settings 1 (Prox Settings 1)							
Access	Bit	7	6	5	4	3	2	1	0
R/W	Name	Comms WDT OFF	Event Mode OFF	Debug I2C	AO Clear Prox	AO OFF	ACF OFF	ATI OFF	Noise Detect OFF

▪ **[CDH] Prox Settings 1:**

- bit7: Comms WDT OFF – R/W bit. (See **Section 9.2**)
- bit6: Event Mode OFF – Set bit to disable Event Mode I²C.
- bit5: Debug I²C – Bit is set during I²C operation. (Do not clear)
- bit4: AO Clear Prox – Set bit to clear Auto-OFF timer on Prox.
- bit3: AO OFF – Set bit to disable Auto-OFF function.
- bit2: ACF OFF – Bit is set if AC Filter is Disabled. (R/W)
- bit1: ATI OFF – Set bit to disable Auto-ATI functionality. (See **Section 8.9**)
- bit0: Noise Detect OFF – Set bit to disable RF detection.

CEH		ProxSense® Module Settings 2 (Prox Settings 2)							
Access	Bit	7	6	5	4	3	2	1	0
R/W	Name					IO_OUT	CS_Cap	Proj_B1	Proj_B0

▪ **[CEH] Prox Settings 2:**

- bit7: Not used.
- bit6: Not used.
- bit5: Not used.
- bit4: Not used.
- bit3: IO_OUT – Set bit to enable/disable additional output on PO/TX pin (IC pin 10) during I²C operation.
- bit2: *CS_Cap – R/W bit for selection of Internal Reference Capacitor size. (0 =29.9pF; 1= 59.8pF)
- bit1:0 *Proj_B1:Proj_B0 – R/W bits for selection of internal bias current for projected capacitance configurations.

***Please Note:** It is **not recommended** to adjust the settings of the internal reference capacitor (Cs) and bias current (i.e. bit2:0) of the *ProxSense® Module Settings 2* register.



D6H		I ² C Debug – Event Mode Event Mask (Event Mask)							
Access	Bit	7	6	5	4	3	2	1	0
R/W	Name				Noise Event	ATI Event	Swipe Event	Touch Event	Prox Event

- **[D6H] Event Mask:**
 - bit7: Not used.
 - bit6: Not used.
 - bit5: Not used.
 - bit4: Noise Event – Set bit to mask RF Noise events during Event Mode I²C comms. (Requires RF-detection = Enabled.)
 - bit3: ATI Event – Set bit to mask ATI events during Event Mode I²C comms.
 - bit2: Swipe Event – Set bit to mask Swipe events during Event Mode I²C comms.
 - bit1: Touch Event – Set bit to mask Touch events during Event Mode I²C comms.
 - bit0: Prox Event – Set bit to mask Proximity events during Event Mode I²C comms.



10.2.4.1 Swipe timing settings

E1H		Swipe Min Samples							
Access	Bit	7	6	5	4	3	2	1	0
R/W	Name	Variable: Default = 0x00							

- **[E1H] Swipe Min Samples:** bit7:0: Minimum number of valid samples required per state of the selected Swipe Sequence = $x+1$.
For default (i.e. $0xE1 = 0x00$), Min Swipe samples required per state = 1 per state.
1 Swipe Sample = t_{STATE} – See Section 6.12

E2H		Swipe Max Samples							
Access	Bit	7	6	5	4	3	2	1	0
R/W	Name	Variable: Default = 0x44							

- **[E2H] Swipe Max Samples:** bit7:0: Maximum number of valid samples allowed per state of the selected Swipe Sequence = $x+1$.
For default (i.e. $0xE2 = 0x44$), Max Swipe samples allowed per state = 45 per state.
1 Swipe Sample = t_{STATE} – See Section 6.12

E3H		Swipe Overall Limit							
Access	Bit	7	6	5	4	3	2	1	0
R/W	Name	Variable: Default = 0x04							

- **[E3H] Swipe Overall Limit:** bit7:0: Set Overall Swipe Length Limit = $x*250ms$
For default (i.e. $0xE3 = 0x04$), maximum time allowed to complete a valid swipe = 1 second.
Swipe Overall Limit overrule sum of Swipe Max Samples



11 Electrical Specifications – All Preliminary

11.1 Absolute Maximum Specifications

Note: Exceeding these maximum specifications may cause damage to the device.

Operating temperature	-20°C to 85°C
Supply Voltage ($V_{DDHI} - V_{SS}$)	3.6V
Maximum pin voltage	$V_{DDHI} + 0.5V$
Maximum continuous current (specific pins)	2mA
Pin voltage (Cx)	V_{REG}
Minimum pin voltage	$V_{SS} - 0.5V$
Minimum power-on slope	100V/s
ESD protection (Human Body Model)	±4kV
Maximum pin temperature during soldering	350°C (5 seconds)
Maximum load capacitance – Cx to GND	100pF
Maximum Rx-Tx Mutual capacitance (Cm)	9pF

11.2 General Characteristics (Measured at 25°C)

Table 11.1 IQS213A General Operating Conditions (a)

DESCRIPTION	Conditions	PARAMETER	MIN	TYP	MAX	UNIT
Supply voltage		V_{DDHI}	1.80	3.30	3.60	V
Internal regulator output	$1.80 \leq V_{DDHI} \leq 3.60$	V_{REG}	1.63	1.70	1.77	V
Normal Power operating current ¹ $t_{LP} = N/A$ $1.80 \leq V_{DDHI} \leq 3.60$	2CH Self	$I_{IQS213A_NP}$	145	175	210	μA
	3CH Self		150	180	215	μA
Low power 1 operating current ¹ $t_{LP} = 128ms$ $1.80 \leq V_{DDHI} \leq 3.60$	2CH Self	$I_{IQS213A_LP1}$	3.85	4.65	5.65	μA
	3CH Self		3.90	4.70	5.70	μA
Low power 2 operating current ¹ $t_{LP} = 256ms$ $1.80 \leq V_{DDHI} \leq 3.60$	2CH Self	$I_{IQS213A_LP2}$	2.50	3.00	3.60	μA
	3CH Self		2.55	3.10	3.65	μA
Low power 3 operating current ¹ $t_{LP} = 512ms$ $1.80 \leq V_{DDHI} \leq 3.60$	2CH Self	$I_{IQS213A_LP3}$	1.75	2.10	2.65	μA
	3CH Self		1.80	2.20	2.75	μA

1. CHG FRQ = 500kHz, ATI Target = 320/160, Normal Touch IC, Stand-Alone, Active High Output. Altering the projected current bias settings, reference capacitor (CS) size, number of active channels and ATI Target values will affect the measured current.



Table 11.2 IQS213A Current Consumption (b)

DESCRIPTION	Conditions	PARAMETER	MIN	TYP	MAX	UNIT
Normal Power operating current ² $t_{LP} = N/A$ $1.80 \leq V_{DDHI} \leq 3.60$	2CH Self	$I_{IQS213A_NP}$	150	180	210	μA
	3CH Self		150	185	215	μA
Low power 1 operating current ² $t_{LP} = 128ms$	2CH Self	$I_{IQS213A_LP1}$	4.35	4.90	5.75	μA
	3CH Self		4.40	4.95	5.80	μA
Low power 2 operating current ² $t_{LP} = 256ms$	2CH Self	$I_{IQS213A_LP2}$	2.85	3.45	4.10	μA
	3CH Self		2.90	3.50	4.15	μA
Low power 3 operating current ² $t_{LP} = 512ms$	2CH Self	$I_{IQS213A_LP3}$	2.15	2.60	3.15	μA
	3CH Self		2.25	2.70	3.25	μA

2. CHG FRQ = 500kHz, ATI Target = 320/160, Event-Mode I2C, 10k Pull-Up's. Altering the projected current bias settings, reference capacitor (CS) size, number of active channels and ATI Target values will affect the measured current.

Table 11.3 IQS213A Current Consumption (c)

DESCRIPTION	Conditions	PARAMETER	MIN	TYP	MAX	UNIT
Normal Power operating current ³ $t_{LP} = N/A$ $1.80 \leq V_{DDHI} \leq 3.60$	2CH Projected	$I_{IQS213A_NP}$		230	250	μA
	3CH Projected			235	250	μA
Low power 1 operating current ³ $t_{LP} = 128ms$	2CH Projected	$I_{IQS213A_LP1}$	4.30	5.10	5.90	μA
	3CH Projected		4.35	5.15	6.00	μA
Low power 2 operating current ³ $t_{LP} = 256ms$	2CH Projected	$I_{IQS213A_LP2}$	2.65	3.20	3.80	μA
	3CH Projected		2.70	3.25	3.90	μA
Low power 3 operating current ³ $t_{LP} = 512ms$	2CH Projected	$I_{IQS213A_LP3}$	1.85	2.25	2.70	μA
	3CH Projected		1.90	2.30	2.75	μA

3. CHG FRQ = 2MHz, ATI Target = 320/160, Stand-Alone, Active High Output. Altering the projected current bias settings, reference capacitor (CS) size, number of active channels and ATI Target values will affect the measured current.

Table 11.4 IQS213A Current Consumption (d)

DESCRIPTION	Conditions	PARAMETER	MIN	TYP	MAX	UNIT
Normal Power operating current ⁴ $t_{LP} = N/A$ $1.80 \leq V_{DDHI} \leq 3.60$	2CH Projected	$I_{IQS213A_NP}$		230	250	μA
	3CH Projected			235	260	μA
Low power 1 operating current ⁴ $t_{LP} = 128ms$	2CH Projected	$I_{IQS213A_LP1}$	5.45	6.35	7.50	μA
	3CH Projected		5.60	6.50	7.60	μA
Low power 2 operating current ⁴ $t_{LP} = 256ms$	2CH Projected	$I_{IQS213A_LP2}$	3.30	3.95	4.65	μA
	3CH Projected		3.40	4.00	4.75	μA
Low power 3 operating current ⁴ $t_{LP} = 512ms$	2CH Projected	$I_{IQS213A_LP3}$	2.40	2.90	3.40	μA
	3CH Projected		2.50	3.00	3.45	μA

4. CHG FRQ = 2MHz, ATI Target = 640/320, Event-Mode I2C, 10k Pull-Up's. Altering the projected current bias settings, reference capacitor (CS) size, number of active channels and ATI Target values will affect the measured current.



Table 11.5 Start-up and shut-down slope Characteristics

DESCRIPTION	Conditions	PARAMETER	MIN	MAX	UNIT
POR	V_{DDHI} Slope $\geq 100V/s$	POR	1	1.55	V
BOD		BOD	1	1.5	V

Table 11.6 Debounce employed on IQS213A

DESCRIPTION	Conditions	Debounce Value
Proximity debounce value	Proximity event	4 (Up and Down)
Touch debounce value	Touch event	2 (Up and Down)

11.3 Timing Characteristics

Table 11.7 Main Oscillator¹

SYMBOL	DESCRIPTION	Conditions	MIN	TYP	MAX	UNIT
F_{OSC}	IQS213A Main oscillator	$1.80 \leq V_{DDHI} \leq 3.60$		4		MHz

1. All timings derived from Main Oscillator

Table 11.8 General Timing Characteristics for $1.80V \leq V_{DDHI} \leq 3.60V$

SYMBOL	DESCRIPTION	Conditions	MIN	TYP	MAX	UNIT
$t_{START-UP}$	Start-up time before the first communication is initiated by the IQS213A			15		ms
f_{CX}	Charge transfer frequency			See CHG_FRQ in Section 8.3		MHz
t_{CHARGE}	Charge time per channel			$CS * (1/f_{CX})$		ms
$t_{CHANNEL}$	Stand-alone / I ² C Mode	Normal Power		2.6 / 3.9		ms
t_{SAMPLE}				Active channels * $t_{CHANNEL}$		ms
t_{WDT}	WDT time-out while communicating			160		ms

Table 11.9 IQS213A Charging Times

POWER MODE	TYPICAL (ms)	
	Stand-alone	I ² C
Normal Power Mode	2.6	3.9
Low Power Mode 1	128	128
Low Power Mode 2	256	256
Low Power Mode 3	512	512

NOTE: with ACF = ON, “wake-on-prox” times will increase due to the CS having to go through an additional filtering process adding a delay. Please refer to “Application Note AZD079 – IQS213 Touch response rate**” for more information.



12 Packaging Information

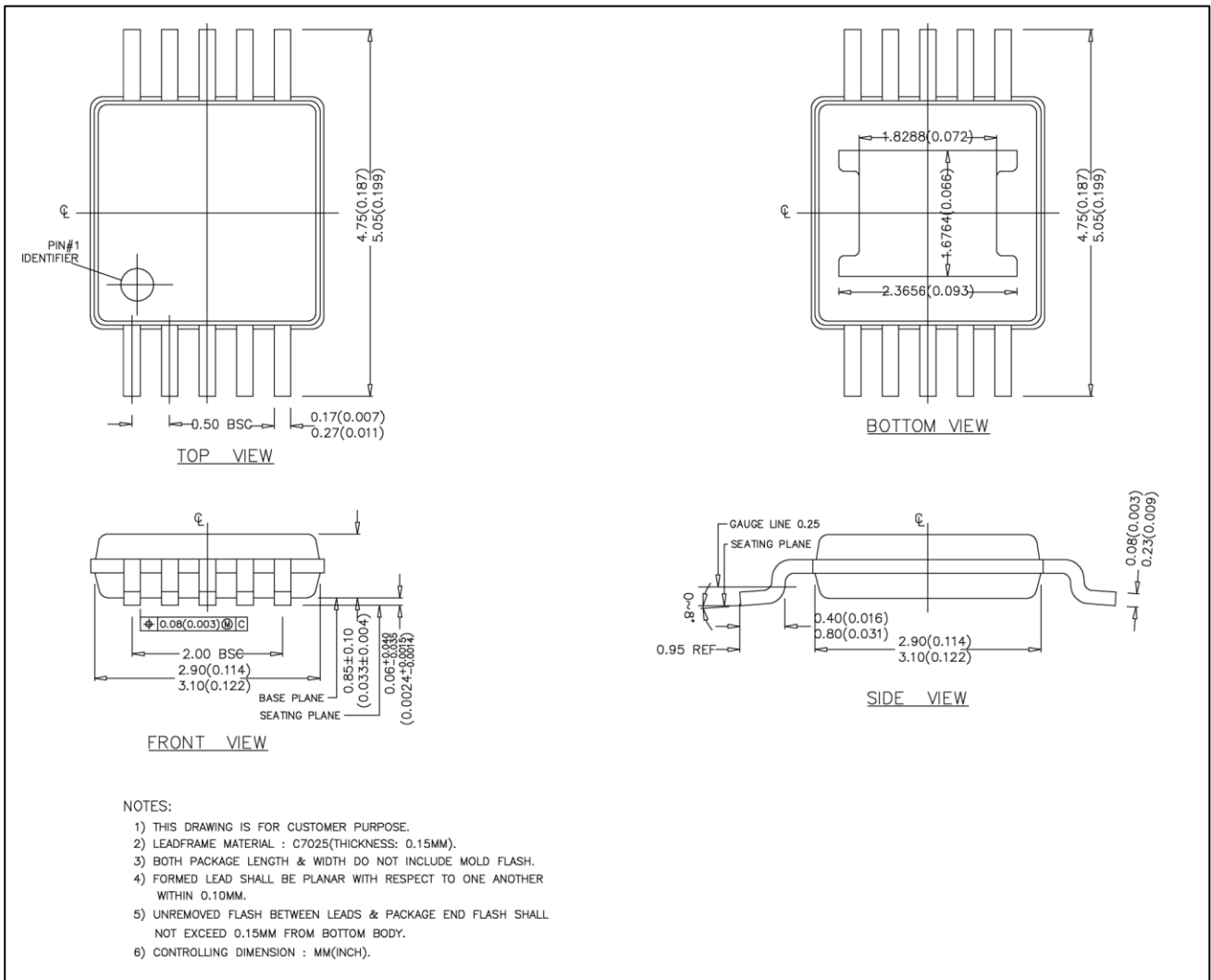

Figure 12.1 MSOP-10 Package Dimensions

MSOP-10 PCB Footprint Dimensions:

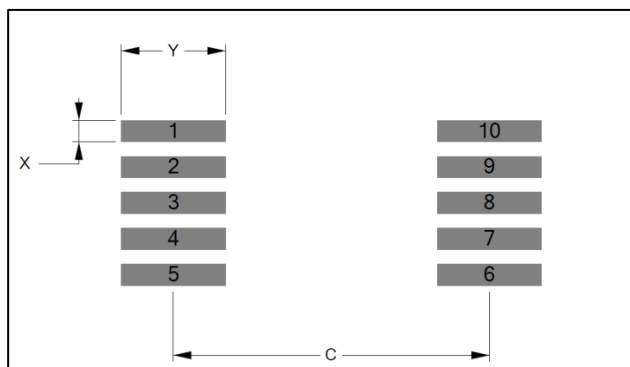
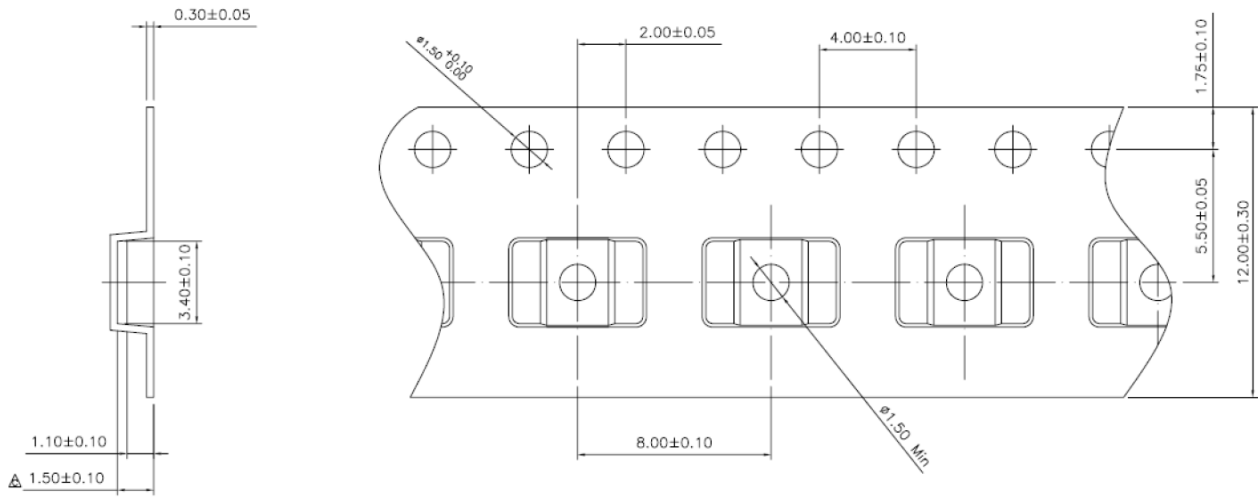

Figure 12.2 MSOP-10 PCB Footprint

Dimension	[mm]
Pitch	0.50
C	4.40
Y	1.45
X	0.30



12.1 Tape and Reel Specification



NOTES:

1. 10 sprocket hole pitch cumulative tolerance ±0.2
2. Camber not to exceed 1mm in 100mm
3. Material:Black conductive Polystyrene
4. Ao and Bo measured on a plane 0.3mm above the bottom of the pocket
5. Ko measured from a plane on the inside bottom of the pocket to the top surface of the carrier
6. Pocket position relative to sprocket hole measured as true position of pocket ,not pocket hole.
7. Pocket center and pocket hole center must be same position

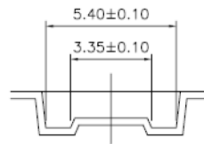

Figure 12.5 MSOP-10 Tape Specification. Bulk orientation LT

12.2 Package MSL

Moisture Sensitivity Level (MSL) relates to the packaging and handling precautions for some semiconductors. The MSL is an electronic standard for the time period in which a moisture sensitive device can be exposed to ambient room conditions (approximately 30°C/85%RH see J-STD033C for more info) before reflow occur.

Table 12.1 MSOP-10 MSL classification

Package	Level (duration)
MSOP-10	MSL 1 (Unlimited at ≤30 °C/85% RH) Reflow profile peak temperature < 260 °C for < 25 seconds Number of Reflow ≤ 3



13 Device Marking

13.1 Top marking

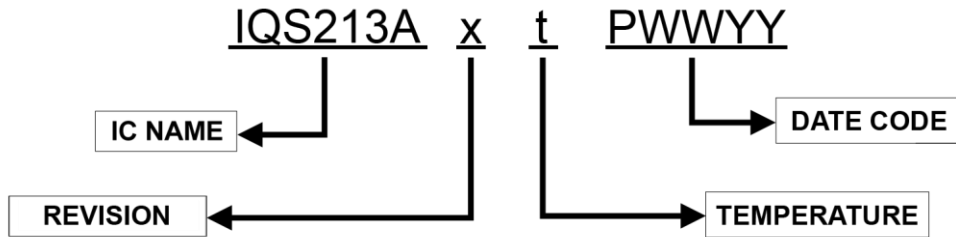

IC NAME	IQS213A	=	IQS213A
REVISION	x	=	IC Revision Number
TEMPERATURE RANGE	t	=	i -20°C to 85°C (Industrial) c 0°C to 70°C (Commercial)
DATE CODE	P	=	Package House
	WW	=	Week
	YY	=	Year

13.2 Bottom Marking



Configuration	zzzzzzzz	=	Device Configuration / User Programmable Options [Default = 00000000]
----------------------	-----------------	---	---



14 Ordering Information

Orders will be subject to a MOQ (Minimum Order Quantity) of a full reel. Contact the official distributor for sample quantities. A list of the distributors can be found under the “Distributors” section of www.azoteq.com.

14.1 General Part Order Number

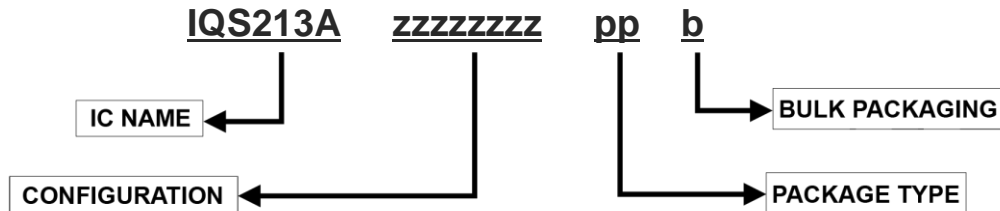

IC NAME	IQS213A	=	IQS213A
CONFIGURATION	zzzzzzzz	=	User Programmable Option Selection
PACKAGE TYPE	MS	=	MSOP10
BULK PACKAGING	R	=	Reel (4000pcs/reel)



15 Contact Information

	USA	Asia	South Africa
Physical Address	6507 Jester Blvd Bldg 5, suite 510G Austin TX 78750 USA	Rm1227, Glittery City Shennan Rd Futian District Shenzhen, 518033 China	109 Main Street Paarl 7646 South Africa
Postal Address	6507 Jester Blvd Bldg 5, suite 510G Austin TX 78750 USA	Rm1227, Glittery City Shennan Rd Futian District Shenzhen, 518033 China	PO Box 3534 Paarl 7620 South Africa
Tel	+1 512 538 1995	+86 755 8303 5294 ext 808	+27 21 863 0033
Fax	+1 512 672 8442		+27 21 863 1512
Email	info@azoteq.com	info@azoteq.com	info@azoteq.com

Please visit www.azoteq.com for a list of distributors and worldwide representation.

The following patents relate to the device or usage of the device: US 6,249,089; US 6,952,084; US 6,984,900; US 8,395,395; US 8,531,120; US 8,659,306; US 9,209,803; US 9,360,510; US 9,496,793; US 9,709,614; US 9,948,297; EP 2,351,220; EP 2,559,164; EP 2,748,927; EP 2,846,465; HK 1,157,080; SA 2001/2151; SA 2006/05363; SA 2014/01541; SA 2017/02224;

AirButton®, Azoteq®, Crystal Driver®, IQ Switch®, ProxSense®, ProxFusion®, LightSense™, SwipeSwitch™, and the  logo are trademarks of Azoteq.

The information in this Datasheet is believed to be accurate at the time of publication. Azoteq uses reasonable effort to maintain the information up-to-date and accurate, but does not warrant the accuracy, completeness or reliability of the information contained herein. All content and information are provided on an "as is" basis only, without any representations or warranties, express or implied, of any kind, including representations about the suitability of these products or information for any purpose. Azoteq disclaims all warranties and conditions with regard to these products and information, including but not limited to all implied warranties and conditions of merchantability, fitness for a particular purpose, title and non-infringement of any third party intellectual property rights. Azoteq assumes no liability for any damages or injury arising from any use of the information or the product or caused by, without limitation, failure of performance, error, omission, interruption, defect, delay in operation or transmission, even if Azoteq has been advised of the possibility of such damages. The applications mentioned herein are used solely for the purpose of illustration and Azoteq makes no warranty or representation that such applications will be suitable without further modification, nor recommends the use of its products for application that may present a risk to human life due to malfunction or otherwise. Azoteq products are not authorized for use as critical components in life support devices or systems. No licenses to patents are granted, implicitly, express or implied, by estoppel or otherwise, under any intellectual property rights. In the event that any of the abovementioned limitations or exclusions does not apply, it is agreed that Azoteq's total liability for all losses, damages and causes of action (in contract, tort (including without limitation, negligence) or otherwise) will not exceed the amount already paid by the customer for the products. Azoteq reserves the right to alter its products, to make corrections, deletions, modifications, enhancements, improvements and other changes to the content and information, its products, programs and services at any time or to move or discontinue any contents, products, programs or services without prior notification. For the most up-to-date information and binding Terms and Conditions please refer to www.azoteq.com.

www.azoteq.com/ip

info@azoteq.com