

Features

- Ultra Low V_F per Footprint Area
- Low Leakage
- Low Thermal Resistance
- One-fifth Footprint of SMA
- Super Low Profile (<.8mm)
- Available Tested on Tape & Reel



Major Ratings and Characteristics

Characteristics	IR1H40CSP	Units
$I_{F(AV)}$ Rectangular waveform	1.0	A
V_{RRM}	40	V
I_{FSM} @ $t_p = 5 \mu s$ sine	250	A
V_F @1.0A pk, $T_J = 125^\circ C$	0.42	V
T_J range	-55 to 150	$^\circ C$

Description

True chip-scale packaging is available from International Rectifier. The IR1H40CSP surface-mount Schottky rectifier has been designed for applications requiring low forward drop and very small foot prints on PC boards. Typical applications are in disk drives, switching power supplies, converters, free-wheeling diodes, battery charging, and reverse battery protection.

- Small foot print, surface mountable
- Low forward voltage drop
- High frequency operation
- Guard ring for enhanced ruggedness and long term reliability

The Flipky™ package, is one-fifth the footprint of a comparable SMA package and has a profile of less than .8mm. Combined with the low thermal resistance of the die level device, this makes the Flipky™ the best device for application where printed circuit board space is at a premium and in extremely thin application environments such as battery packs, cell phones and PCMCIA cards.

Voltage Ratings

Part number	IR1H40CSP
V_R Max. DC Reverse Voltage (V)	40
V_{RWM} Max. Working Peak Reverse Voltage (V)	

Absolute Maximum Ratings

Parameters	Value	Units	Conditions
$I_{F(AV)}$ Max. Average Forward Current	1.0	A	50% duty cycle @ $T_{PCB} = 117^\circ\text{C}$, rectangular waveform
I_{FSM} Max. Peak One Cycle Non-Repetitive Surge Current @ 25°C	250	A	Following any rated load condition and with rated V_{RRM} applied
	21		
E_{AS} Non-Repetitive Avalanche Energy	10	mJ	$T_J = 25^\circ\text{C}$, $I_{AS} = 2.0\text{A}$, $L = 5.0\text{mH}$
I_{AR} Repetitive Avalanche Current	2.0	A	Current decaying linearly to zero in $1\mu\text{sec}$ Frequency limited by T_J max. $V_a = 1.5 \times V_r$ typical

Electrical Specifications

Parameters	Typ.	Max.	Units	Conditions	
V_{FM} Max. Forward Voltage (1) Drop * See Fig. 1	0.48	0.52	V	@ 1A	$T_J = 25^\circ\text{C}$
	0.53	0.57		@ 2A	
	0.36	0.42		@ 1A	$T_J = 125^\circ\text{C}$
	0.43	0.50		@ 2A	
I_{RM} Max. Reverse Leakage (1) Current * See Fig. 2	4	10	μA	$T_J = 25^\circ\text{C}$	$V_R = \text{rated } V_R$
	0.5	1			$V_R = 20\text{V}$
	0.2	0.5			$V_R = 10\text{V}$
	0.15	0.3			$V_R = 5\text{V}$
	2.5	4	mA	$T_J = 125^\circ\text{C}$	$V_R = \text{rated } V_R$
	0.9	2			$V_R = 20\text{V}$
	0.6	1.5			$V_R = 10\text{V}$
	0.5	1			$V_R = 5\text{V}$
C_T Max. Junction Capacitance	-	160	pF	$V_R = 5V_{DC}$ (test signal range 100kHz to 1MHz) 25°C	
dv/dt Max. Voltage Rate of Charge	-	10000	V/ μs	(Rated V_R)	

(1) Pulse Width < 300 μs , Duty Cycle < 2%

Thermal-Mechanical Specifications

Parameters	Value	Units	Conditions
T_J Max. Junction Temperature Range (*)	-55 to 150	$^\circ\text{C}$	
T_{stg} Max. Storage Temperature Range	-55 to 150	$^\circ\text{C}$	
R_{thJL} Typ. Thermal Resistance Junction to PCB (**)	40	$^\circ\text{C}/\text{W}$	DCoperation
R_{thJA} Max. Thermal Resistance Junction to Ambient	62	$^\circ\text{C}/\text{W}$	

(*) $\frac{dP_{tot}}{dT_J} < \frac{1}{R_{th(j-a)}}$ thermal runaway condition for a diode on its own heatsink

(**) Mounted 1 inch square PCB

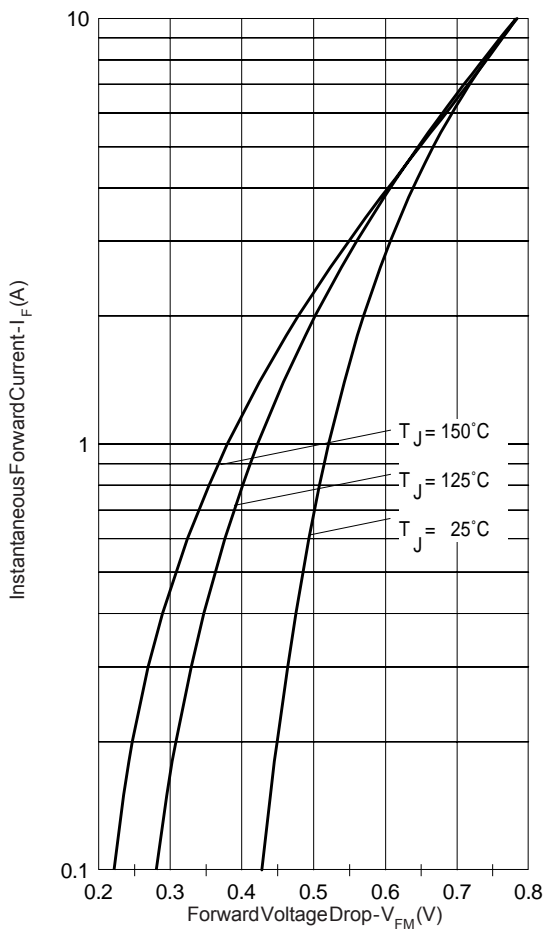

Fig. 1 - Max. Forward Voltage Drop Characteristics (Per Leg)

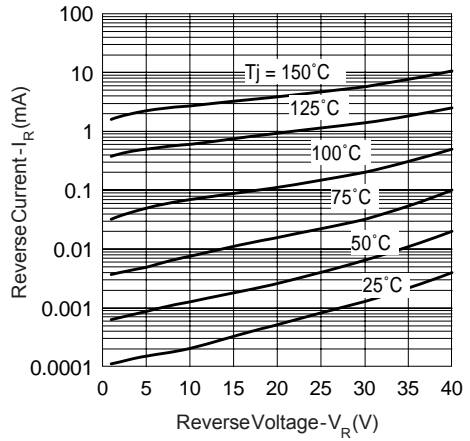

Fig. 2 - Typical Values Of Reverse Current Vs. Reverse Voltage (Per Leg)

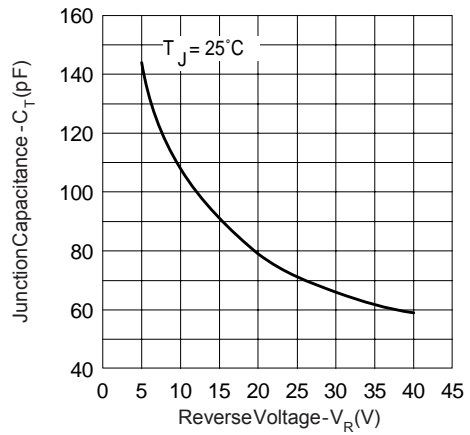

Fig. 3 - Typical Junction Capacitance Vs. Reverse Voltage (Per Leg)

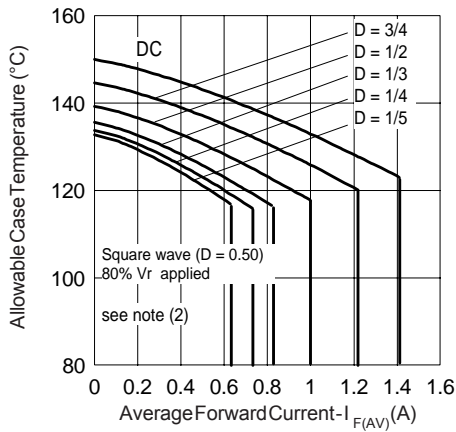

Fig. 4- Max. Allowable Case Temperature Vs. Average Forward Current (PerLeg)

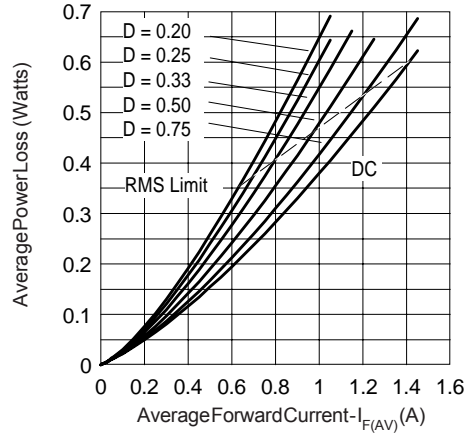

Fig. 5- Forward Power Loss Characteristics (PerLeg)

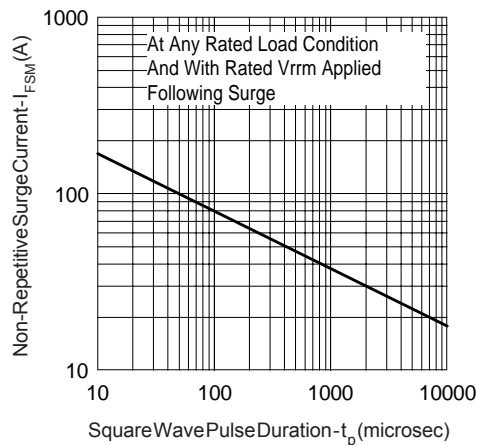

Fig. 6- Max. Non-Repetitive Surge Current (PerLeg)

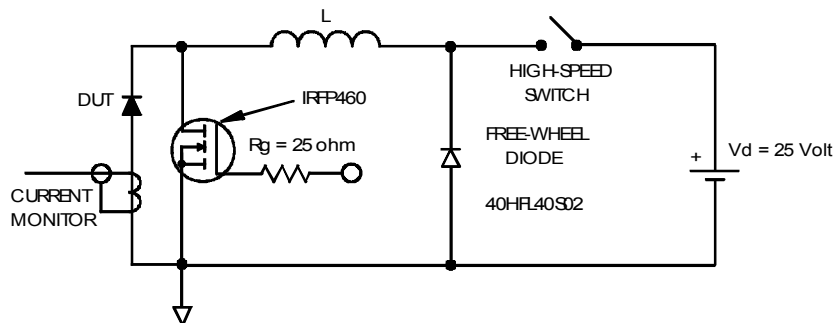

Fig. 8- Unclamped Inductive Test Circuit

(2) Formula used: $T_c = T_j - (Pd + Pd_{REV}) \times R_{thJC}$;

Pd = Forward Power Loss = $I_{F(AV)} \times V_{FM} @ (I_{F(AV)} / D)$ (see Fig. 6);

Pd_{REV} = Inverse Power Loss = $V_{R1} \times I_R (1 - D)$; $I_R @ 80\% V_R$ applied

FlipKY™ Outline Dimension and Tape and Reel

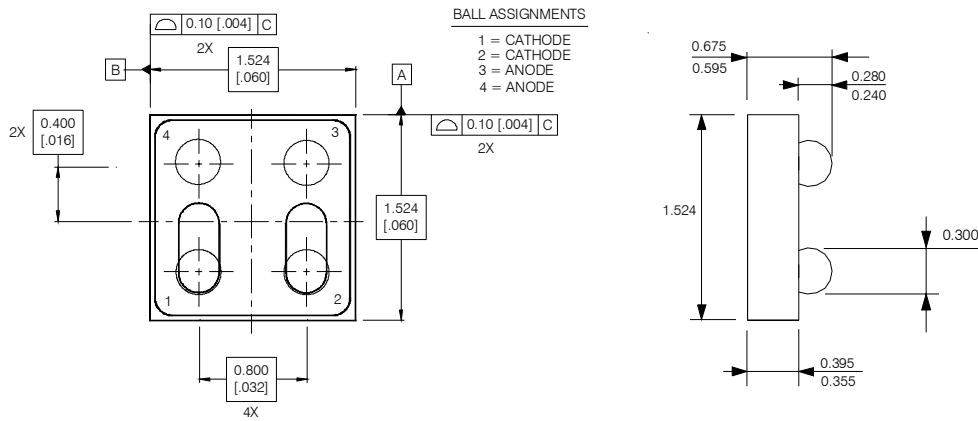

- NOTES:
 1. DIMENSIONING & TOLERANCING PER ASME Y14.5M-1994.
 2. CONTROLLING DIMENSION: MILLIMETER
 3. DIMENSIONS ARE SHOWN IN MILLIMETERS [INCHES].

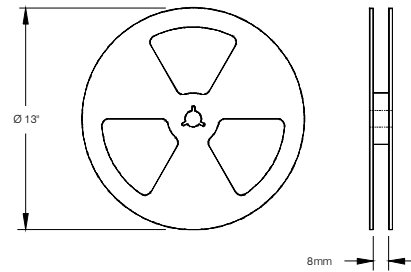
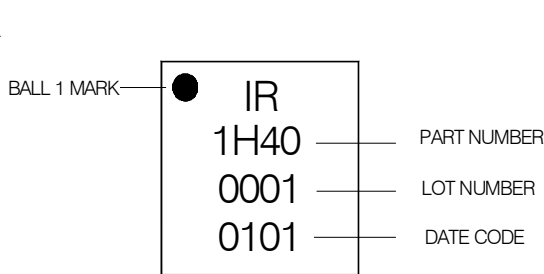

RECOMMENDED FOOTPRINT

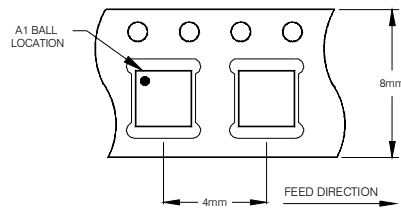
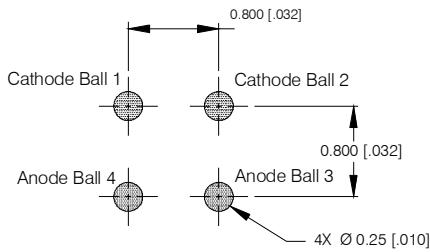

- NOTES:
 1. TAPE AND REEL OUTLINE CONFORMS TO EIA-481 & EIA-541.

```

IR1H40CSP
*****
*       This model has been developed by       *
*       Wizard SPICE MODEL GENERATOR (1999)   *
*       (International Rectifier Corporation)   *
*       Contain Proprietary Information       *
*****
* SPICE Model Diode is composed by a         *
* simple diode plus paralalled VCG2T         *
*****
.SUBCKT irlh40csp ANO CAT
D1 ANO 1 DMOD (0.01614)
*Define diode model
.MODEL  DMOD  D(IS=1.89451920631734E-05A,N=1.28115932154793,BV=48V,
+  IBV=3.51582918628388E-02A,RS= 0.000316344,CJO=1.496133161627E-08,
+  VJ=2.48275231672173,XTI=2, EG=0.909092986033443)
*****
*Implementation of VCG2T
VX 1 2 DC 0V
R1 2 CAT TRES 1E-6
.MODEL  TRES  RES(R=1,TC1=141.418786575201)
GP1 ANO CAT VALUE={-ABS(I(VX))*(EXP(((((-4.18234E-03/
141.4188)*(V(2,CAT)*1E6)/(I(VX)+1E-6)-1))+1)*0.1008349*ABS(V(ANO,CAT)))-
1)}
*****
.ENDS irlh40csp

```

Data and specifications subject to change without notice.
This product has been designed and qualified for Consumer Level.
Qualification Standards can be found on IR's Web site.

International
IR Rectifier

IR WORLD HEADQUARTERS: 233 Kansas St., El Segundo, California 90245, USA Tel: (310) 252-7105
TAC Fax: (310) 252-7309

Visit us at www.irf.com for sales contact information. 06/05