

FEATURES

- Input Voltage Range: 3V to 27V
- Output Voltage Range: 0.5V to 12V
- Continuous 10A Load Capability
- Constant On-Time Control
- Compensation Loop not Required
- Excellent Efficiency at Very Low Output Currents
- Programmable Switching Frequency and Soft Start
- Thermally Compensated Over Current Protection
- Power Good Output
- Precision Voltage Reference (0.5V, +/-1%)
- Enable Input with Voltage Monitoring Capability
- Pre-bias Start Up
- Thermal Shut Down
- Under/Over Voltage Fault Protection
- Forced Continuous Conduction Mode Option
- Very Small, Low Profile 4mm x 5mm QFN Package

DESCRIPTION

The IR3475 SupIRBuck™ is an easy-to-use, fully integrated and highly efficient DC/DC voltage regulator. The onboard constant on time hysteretic controller and MOSFETs make IR3475 a space-efficient solution that delivers up to 10A of precisely controlled output voltage.

Programmable switching frequency, soft start, and thermally compensated over current protection allows for a very flexible solution suitable for many different applications and an ideal choice for battery powered applications.

Additional features include pre-bias startup, very precise 0.5V reference, under/over voltage shutdown, thermal protection, power good output, and enable input with voltage monitoring capability.

APPLICATIONS

- Notebook and Desktop Computers
- Consumer Electronics – STB, LCD, TV, Printers
- 12V and 24V Distributed Power Systems
- General Purpose POL DC-DC Converters
- Game Consoles and Graphics Cards

BASIC APPLICATION

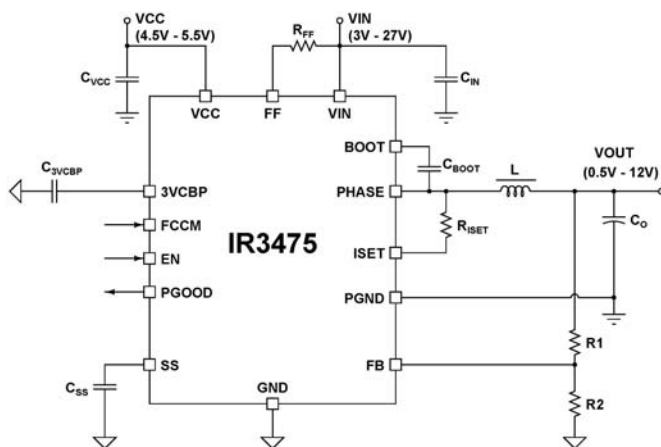

Figure 1: IR3475 Basic Application Circuit

EFFICIENCY

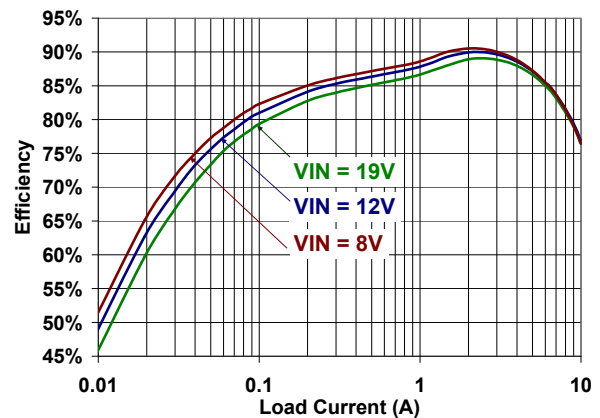
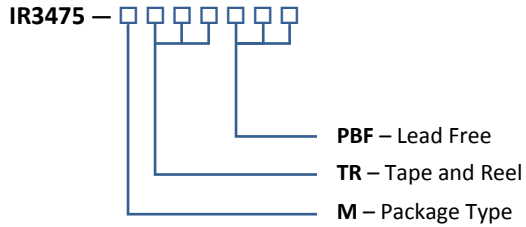

Figure 2: IR3475 Efficiency

ORDERING INFORMATION



Package	Tape & Reel Qty	Part Number
M	750	IR3475MTR1PBF
M	4000	IR3475MTRPBF

MARKING INFORMATION

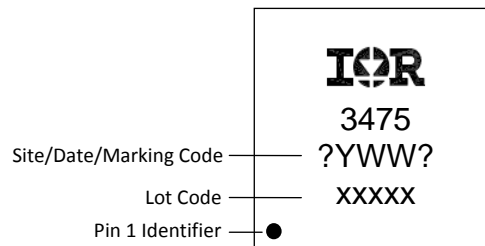

PIN DIAGRAM

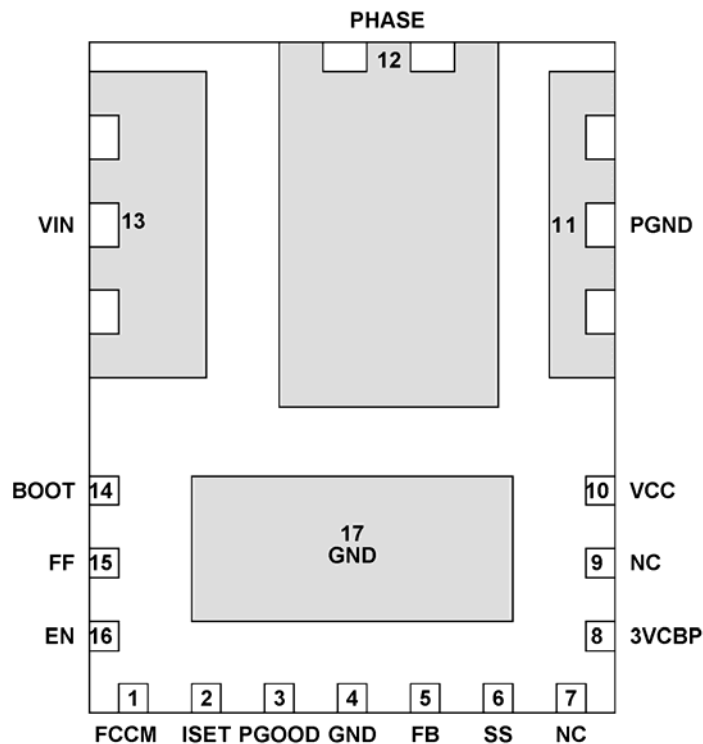

$$\theta_{JA} = 32^{\circ} C/W$$

$$\theta_{J-PCB} = 2^{\circ} C/W$$

FUNCTIONAL BLOCK DIAGRAM

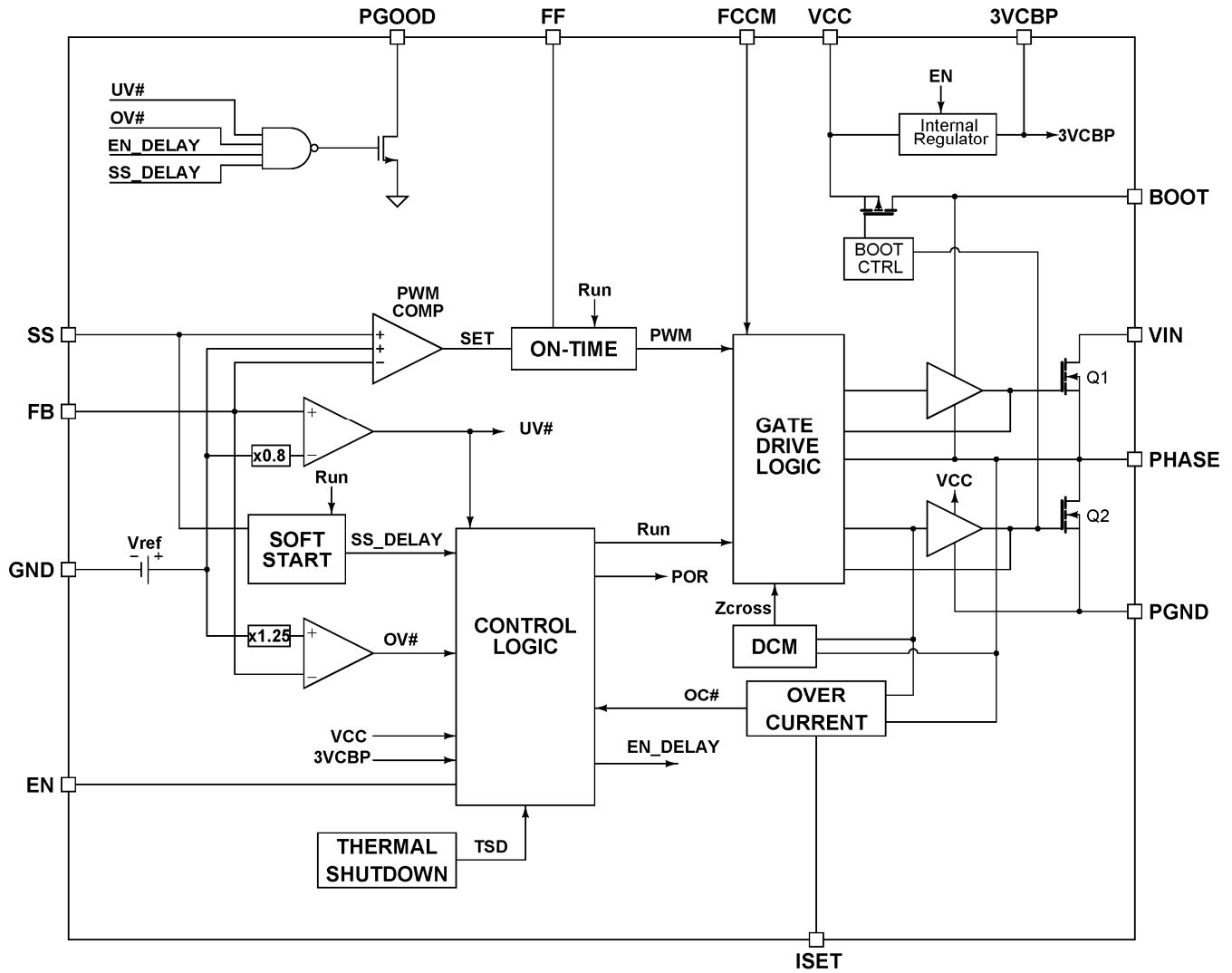

Figure 3: IR3475 Functional Block Diagram

TYPICAL APPLICATION

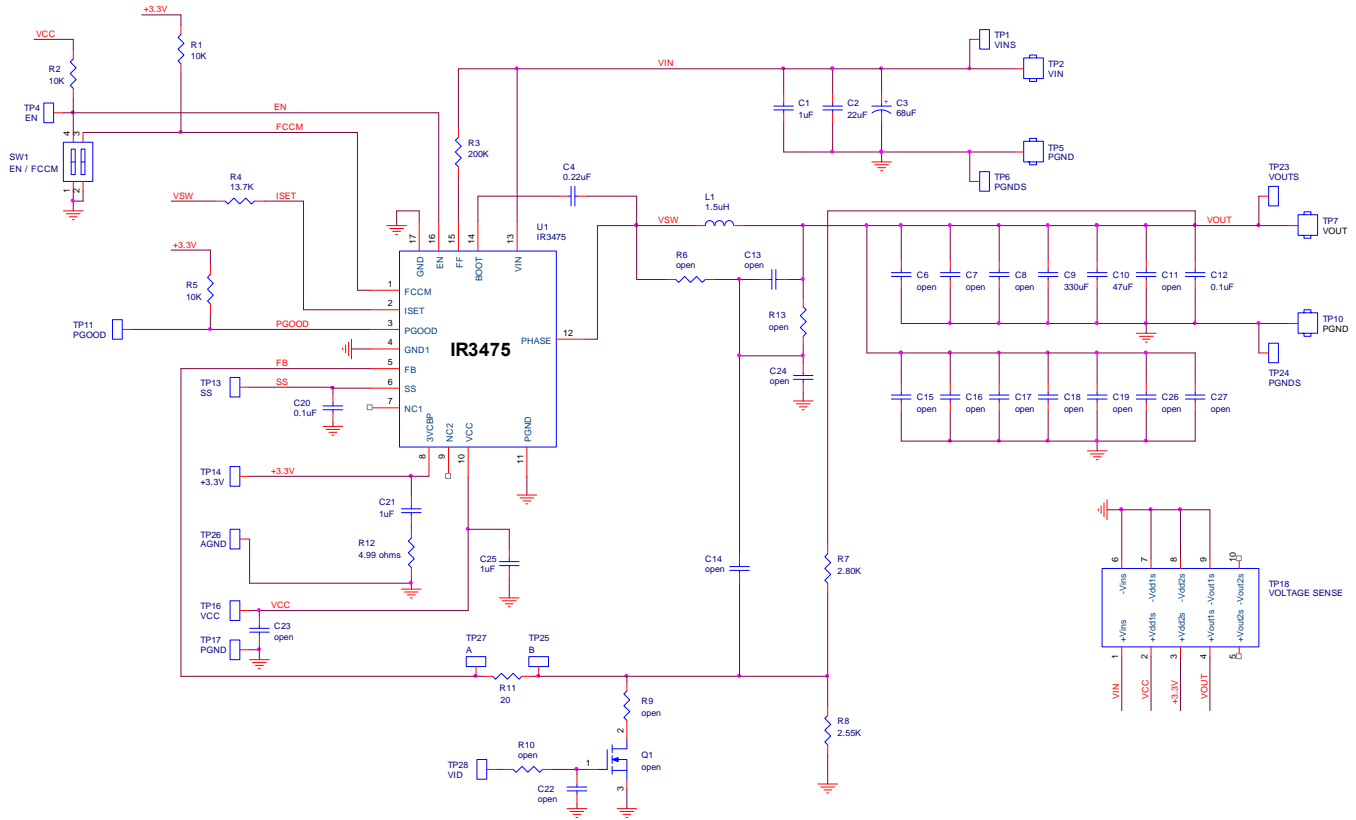

Figure 4: Demoboard Schematic for VOUT = 1.05V, F_s = 300kHz

DEMOBOARD BILL OF MATERIALS

QTY	REFERENCE DESIGNATOR	VALUE	DESCRIPTION	MANUFACTURER	PART NUMBER
3	C1, C21, C25	1.00uF	capacitor, X7R, 1.00uF, 25V, 0.1, 0603	Murata	GRM188R71E105KA12D
1	C10	47uF	capacitor, 47uF, 6.3V, 805	TDK	C2012X5R0J476M
2	C12, C20	0.100uF	capacitor, X7R, 0.100uF, 25V, 0.1, 603	TDK	C1608X7R1E104K
1	C2	22.0uF	capacitor, X5R, 22.0uF, 16V, 20%, 1206	Taiyo Yuden	EMK316BJ226ML-T
1	C3	68uF	capacitor, electrolytic, 68uF, 25V, 0.2, SMD	Panasonic	EEV-FK1E680P
1	C4	0.22uF	capacitor, X5R, 0.22uF, 10V, 0.1, 0603	TDK	C1608X5R1A224K
1	C9	330uF	capacitor, electrolytic, 330uF, 2.5V, 0.2, 7343	Sanyo	2R5TPE330M9
1	L1	1.5uH	inductor, ferrite, 1.5uH, 16.0A, 3.8mOhm, SMT	Cyntec	PIMB104T-1R5MS-39
3	R1, R2, R5	10.0K	resistor, thick film, 10.0K, 1/10W, 0.01, 0603	KOA	RK73H1J1002F
1	R11	20	resistor, thick film, 20, 1/10W, 0.01, 603	KOA	RK73H1JLTD20R0F
1	R12	4.99	resistor, thick film, 4.99, 1/10W, 0.01, 603	Vishay/Dale	CRCW06034999FNEA
1	R3	200K	resistor, thick film, 200K, 1/10W, 0.01, 603	KOA	RK73H1JLTD2003F
1	R4	13.7K	resistor, thick film, 13.7K, 1/10W, 0.01, 603	KOA	RK73H1JLTD1372F
1	R7	2.80K	resistor, thick film, 2.80K, 1/10W, 0.01, 603	KOA	RK73H1JLTD2801F
1	R8	2.55K	resistor, thick film, 2.55K, 1/10W, 0.01, 0603	KOA	RK73H1J2551F
1	SW1	SPST	switch, DIP, SPST, 2 position, SMT	C&K Components	SD02H05K
1	U1	IR3475	4mm x 5mm QFN	IRF	IR3475MTRPBF

PIN DESCRIPTIONS

PIN #	PIN NAME	I/O LEVEL	PIN DESCRIPTION
1	FCCM	3.3V	Forced Continuous Conduction Mode (CCM). Ground this pin to enable diode emulation mode or discontinuous conduction mode (DCM). Pull this pin to 3.3V to operate in CCM under all load conditions.
2	ISET		Connecting resistor to PHASE pin sets over current trip point.
3	PGOOD	5V	Power good open drain output – pull up with a resistor to 3.3V
4, 17	GND	Reference	Bias return and signal reference.
5	FB	3.3V	Inverting input to PWM comparator, OVP / PGOOD sense.
6	SS	3.3V	Soft start/shutdown. This pin provides user programmable soft-start function. Connect an external capacitor from this pin to GND to set the startup time of the output voltage. The converter can be shutdown by pulling this pin below 0.3V.
7	NC	-	-
8	3VCBP	3.3V	For internal LDO. Bypass with a 1.0μF capacitor to AGND. A resistor in series with the bypass capacitor may be required in single-ground plane designs. Refer to <i>Layout Recommendation</i> for details.
9	NC	-	-
10	VCC	5V	VCC input. Gate drive supply. A minimum of 1.0μF ceramic capacitor is required.
11	PGND	Reference	Power return.
12	PHASE	VIN	Phase node (or switching node) of MOSFET half bridge.
13	VIN	VIN	Input voltage for the system.
14	BOOT	VIN + VCC	Bootstrapped gate drive supply – connect a capacitor to PHASE.
15	FF	VIN	Input voltage feed forward – sets on-time with a resistor to VIN.
16	EN	5V	Enable pin to turn on and off the device. Use two external resistors to set the turn on threshold (see <i>Electrical Specifications</i>) for input voltage monitoring.

ABSOLUTE MAXIMUM RATINGS

Stresses beyond those listed under “Absolute Maximum Ratings” may cause permanent damage to the device. These are stress ratings only and functional operation of the device at these or any other conditions beyond those indicated in the operational sections of the specifications are not implied.

VIN, FF	-0.3V to 30V
VCC, PGOOD, EN	-0.3V to 8V
BOOT	-0.3V to 38V
PHASE	-0.3V to 30V (DC), -5V (100ns)
BOOT to PHASE	-0.3V to 8V
ISET	-0.3V to 30V, 30mA
PGND to GND	-0.3V to +0.3V
All other pins	-0.3V to 3.9V
Storage Temperature Range	-65°C to 150°C
Junction Temperature Range	-40°C to 150°C
ESD Classification	JEDEC Class 1C
Moisture Sensitivity Level	JEDEC Level 2 @ 260°C (Note 2)

ELECTRICAL SPECIFICATIONS

RECOMMENDED OPERATING CONDITIONS FOR RELIABLE OPERATION WITH MARGIN

	SYMBOL	MIN	MAX	UNITS
Recommended VIN Range	VIN	3	27*	V
Recommended VCC Range	VCC	4.5	5.5	
Recommended Output Voltage Range	V _{OUT}	0.5	12	
Recommended Output Current Range	I _{OUT}	0	10	A
Recommended Switching Frequency	F _S	N/A	750	kHz
Recommended Operating Junction Temperature	T _J	-40	125	°C

* PHASE pin must not exceed 30V.

ELECTRICAL CHARACTERISTICS

Unless otherwise specified, these specifications apply over VIN = 12V, 4.5V < VCC < 5.5V, 0°C ≤ T_J ≤ 125°C.

PARAMETER	SYMBOL	CONDITIONS	MIN	TYP	MAX	UNIT
Control Loop						
Reference Accuracy	V _{REF}	V _{FB} = 0.5V	0.495	0.5	0.505	V
On-Time Accuracy		R _{FF} = 180K, T _J = 65°C	280	300	320	ns
Min. Off Time				500	580	ns
Soft-Start Current		EN = High	8	10	12	μA
DCM Comparator Offset		Measure at V _{PHASE}	-4.5	-2.5	0	mV
Feedback Input Current		V _{FB} = 0.5V, T _A = 25°C, Note 1		0.01	0.2	μA
Supply Current						
VCC Supply Current (standby)		EN = Low, No Switching		23		μA
VCC Supply Current (dynamic)		EN = High, F _S = 300kHz		7		mA
FF Shutdown Current		EN = Low, R _{FF} = 180K		2		μA
Forced Continuous Conduction Mode (FCCM)						
FCCM Start Threshold			2			V
FCCM Stop Threshold					0.6	V
Gate Drive						
Deadtime		Monitor body diode conduction on PHASE pin, Note 1	5		30	ns
Bootstrap PFET						
Forward Voltage		I(BOOT) = 10mA		300		mV
Upper MOSFET						
Static Drain-to-Source On-Resistance		VCC = 5V, I _D = 10A, T _J = 25°C		25	32	mΩ
Lower MOSFET						
Static Drain-to-Source On-Resistance		VCC = 5V, I _D = 10A, T _J = 25°C		13	17	mΩ

PARAMETER	SYMBOL	CONDITIONS	MIN	TYP	MAX	UNIT
Fault Protection						
ISET Pin Output Current		On the basis of 25°C	17	19	21	μA
ISET Pin Output Current Temperature Coefficient		On the basis of 25°C, Note 1		4400		ppm/°C
Under Voltage Threshold		Falling V_{FB} & Monitor PGOOD	0.37	0.4	0.43	V
Under Voltage Hysteresis		Rising V_{FB} , Note 1		7.5		mV
Over Voltage Threshold		Rising V_{FB} & Monitor PGOOD	0.586	0.625	0.655	V
Over Voltage Hysteresis		Falling V_{FB} , Note 1		7.5		mV
VCC Turn-on Threshold		-40°C to 125°C	3.9	4.2	4.5	V
VCC Turn-off Threshold			3.6	3.9	4.2	V
VCC Threshold Hysteresis				300		mV
EN Rising Threshold		-40°C to 125°C	1.1	1.25	1.45	V
EN Hysteresis				400		mV
EN Input Current		EN = 3.3V			15	μA
PGOOD Pull Down Resistance				25	50	Ω
PGOOD Delay Threshold	V_{SS}			1		V
Thermal Shutdown Threshold		Note 1	125	140		°C
Thermal Shutdown Threshold Hysteresis		Note 1		20		°C

Note:

1. Guaranteed by design but not tested in production
2. Upgrade to industrial/MSL2 level applies from date codes 1227 (marking explained on application note AN1132 page 2). Products with prior date code of 1227 are qualified with MSL3 for Consumer Market.

TYPICAL OPERATING DATA

Tested with demoboard shown in Figure 4, VIN = 12V, VCC = 5V, VOUT = 1.05V, Fs = 300kHz, TA = 25°C, no airflow, unless otherwise specified.

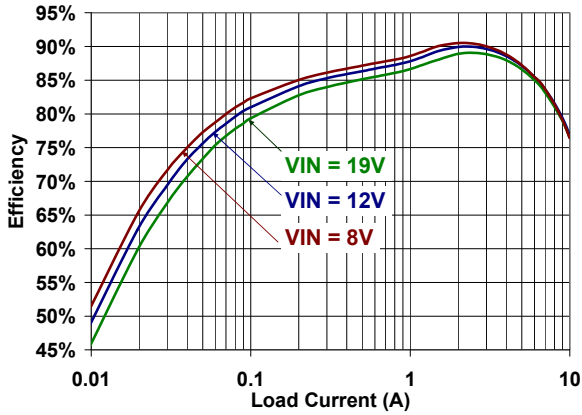

Figure 5: Efficiency vs. Load Current for VOUT = 1.05V

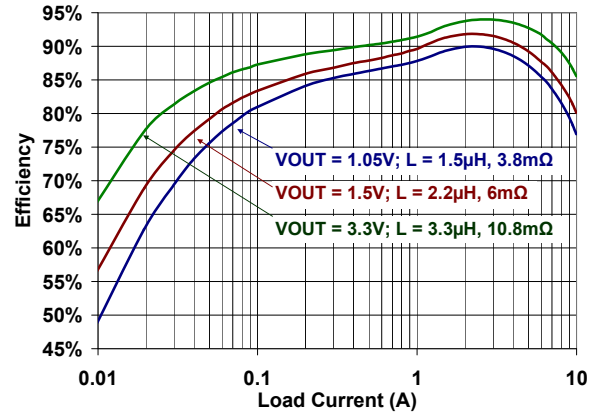

Figure 6: Efficiency vs. Load Current for VIN = 12V

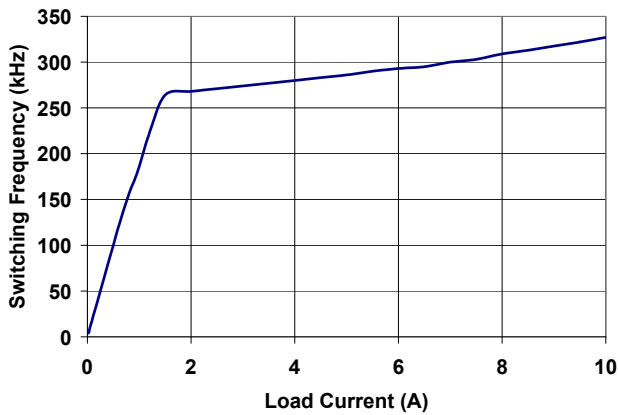

Figure 7: Switching Frequency vs. Load Current

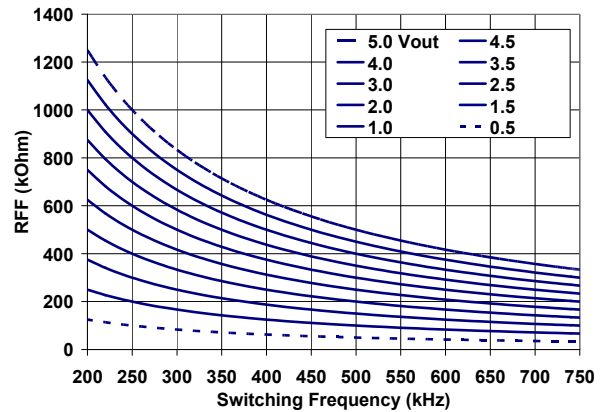

Figure 8: RFF vs. Switching Frequency

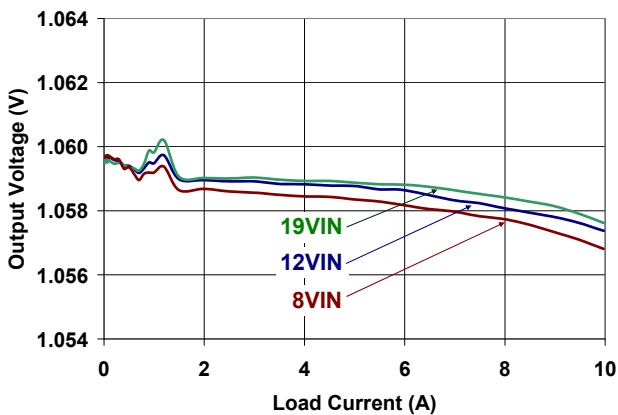

Figure 9: Load Regulation

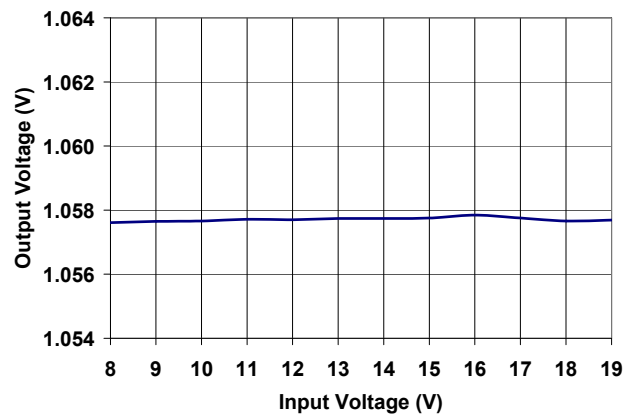

Figure 10: Line Regulation at IOUT = 10A

TYPICAL OPERATING DATA

Tested with demoboard shown in Figure 4, VIN = 12V, VCC = 5V, VOUT = 1.05V, Fs = 300kHz, TA = 25°C, no airflow, unless otherwise specified.

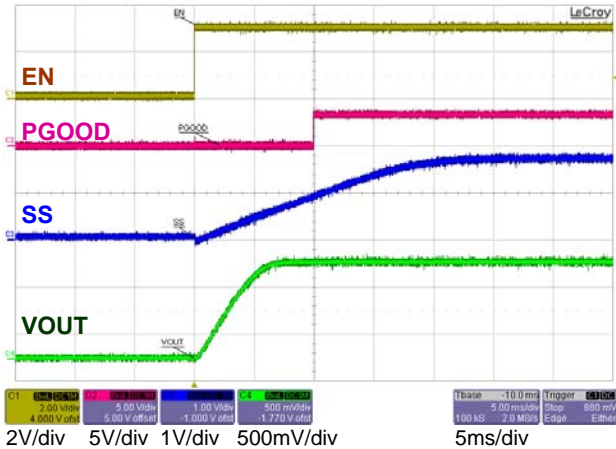

Figure 11: Startup

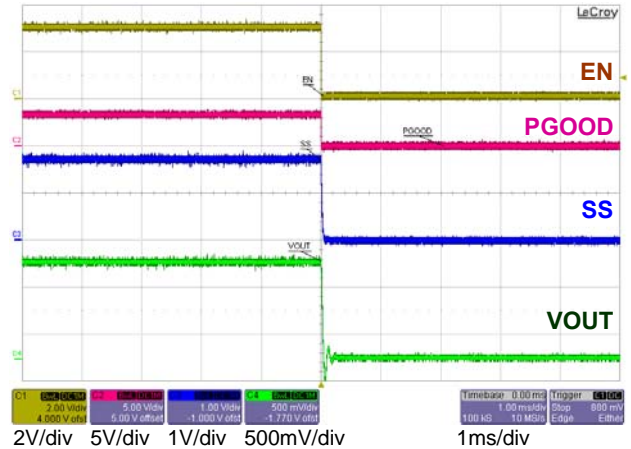

Figure 12: Shutdown

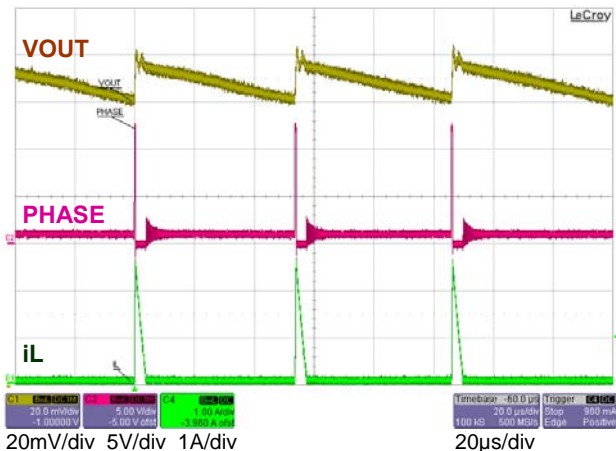

Figure 13: DCM (IOUT = 0.1A)

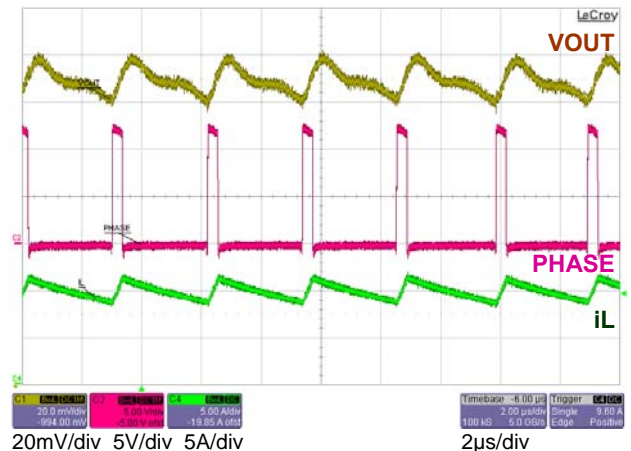

Figure 14: CCM (IOUT = 10A)

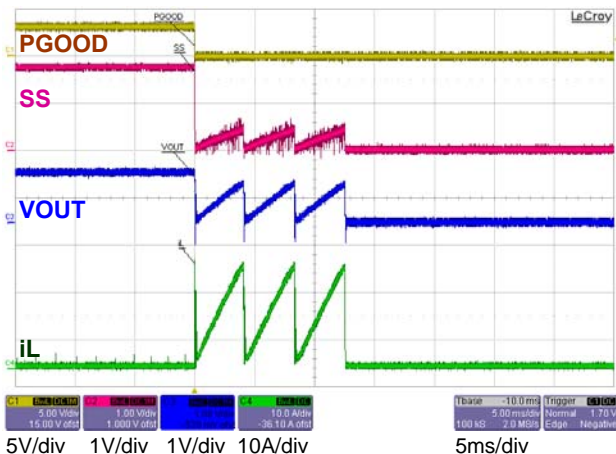

Figure 15: Over Current Protection
(tested by shorting VOUT to PGND)

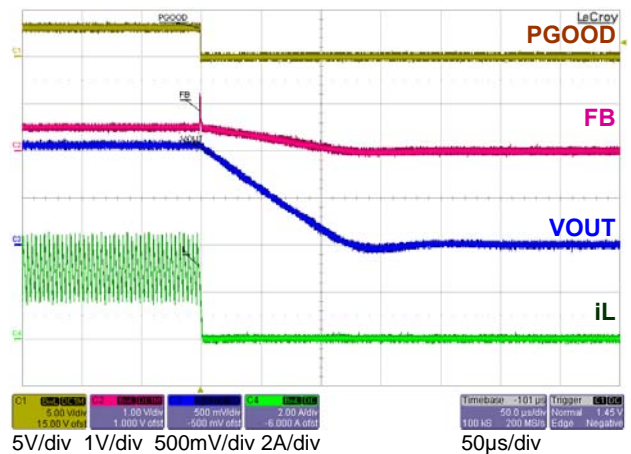

Figure 16: Over Voltage Protection
(tested by shorting FB to VOUT)

TYPICAL OPERATING DATA

Tested with demoboard shown in Figure 4, $V_{IN} = 12V$, $V_{CC} = 5V$, $V_{OUT} = 1.05V$, $F_s = 300kHz$, $T_A = 25^\circ C$, no airflow, unless otherwise specified.

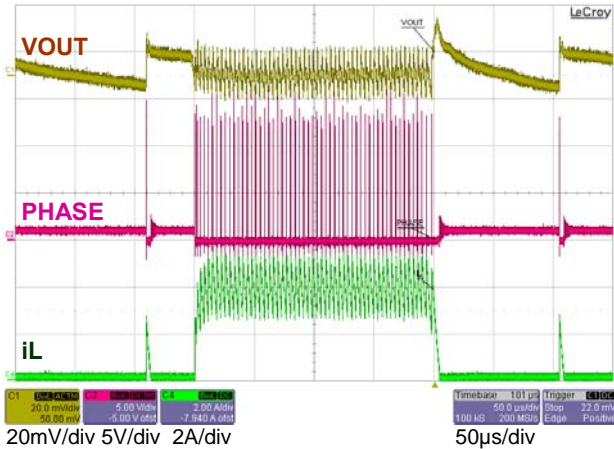

Figure 17: Load Transient 0-4A

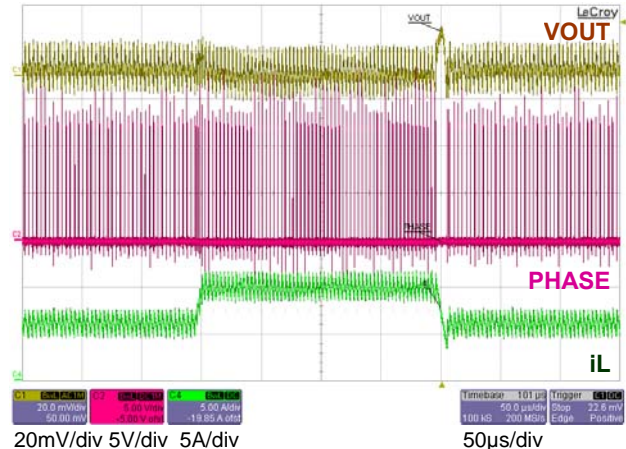

Figure 18: Load Transient 6-10A

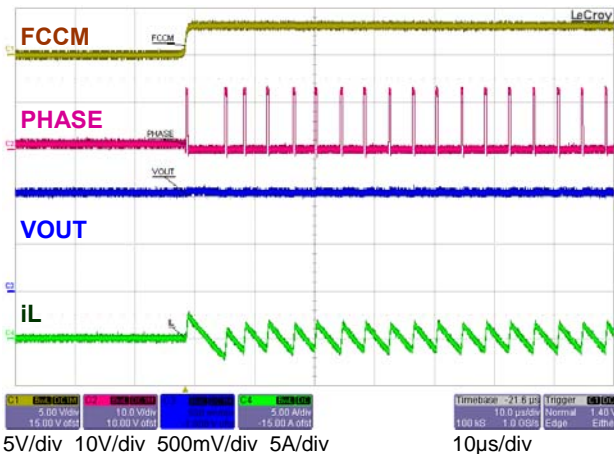

Figure 19: DCM/FCCM Transition

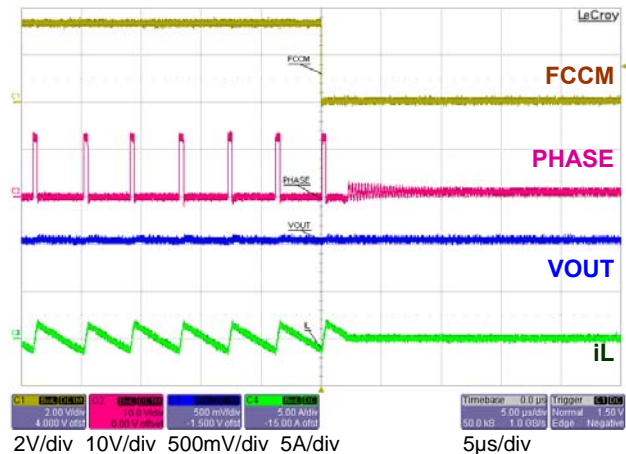

Figure 20: FCCM/DCM Transition

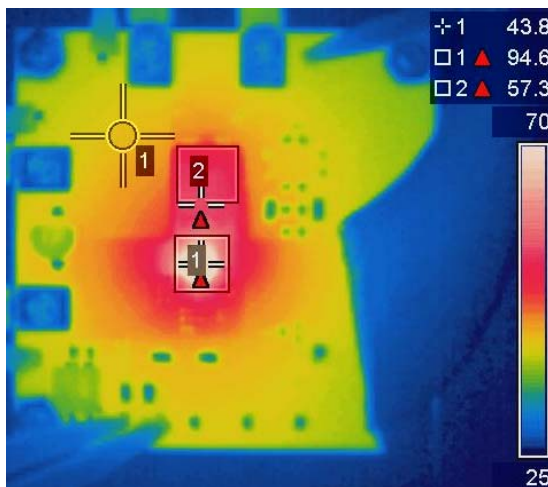

Figure 21: Thermal Image at $V_{IN} = 12V$, $I_{OUT} = 10A$
(IR3475: $95^\circ C$, Inductor: $57^\circ C$, PCB: $44^\circ C$)

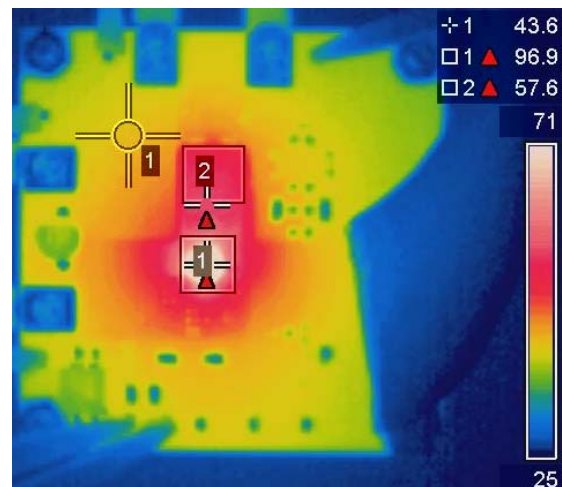

Figure 22: Thermal Image at $V_{IN} = 19V$, $I_{OUT} = 10A$
(IR3475: $97^\circ C$, Inductor: $58^\circ C$, PCB: $44^\circ C$)

THEORY OF OPERATION

PWM COMPARATOR

The PWM comparator initiates a SET signal (PWM pulse) when the FB pin falls below the reference (VREF) or the soft start (SS) voltage.

ON-TIME GENERATOR

The PWM on-time duration is programmed with an external resistor (R_{FF}) from the input supply (V_{IN}) to the FF pin. The simplified equation for R_{FF} is shown in equation 1. The FF pin is held to an internal reference after EN goes HIGH. A copy of the current in R_{FF} charges a timing capacitor, which sets the on-time duration, as shown in equation 2.

$$R_{FF} = \frac{V_{OUT}}{1V \cdot 20pF \cdot F_{SW}} \quad (1)$$

$$T_{ON} = \frac{R_{FF} \cdot 1V \cdot 20pF}{V_{IN}} \quad (2)$$

CONTROL LOGIC

The control logic monitors input power sources, sequences the converter through the soft-start and protective modes, and initiates an internal RUN signal when all conditions are met.

VCC and 3VCBP pins are continuously monitored, and the IR3475 will be disabled if the voltage of either pin drops below the falling thresholds. EN_DELAY will become HIGH when VCC and 3VCBP are in the normal operating range and the EN pin = HIGH.

SOFT START

With EN = HIGH, an internal 10 μ A current source charges the external capacitor (C_{SS}) on the SS pin to set the output voltage slew rate during the soft start interval. The soft start time (t_{SS}) can be calculated from equation 3.

$$t_{SS} = \frac{C_{SS} \cdot 0.5V}{10\mu A} \quad (3)$$

The feedback voltage tracks the SS pin until SS reaches the 0.5V reference voltage (Vref), then feedback is regulated to Vref. C_{SS} will continue to be charged, and when SS pin

reaches V_{SS} (see *Electrical Specification*), SS_DELAY goes HIGH. With EN_DELAY = LOW, the capacitor voltage and SS pin is held to the FB pin voltage. A normal startup sequence is shown in Figure 23.

PGOOD

The PGOOD pin is open drain and it needs to be externally pulled high. High state indicates that output is in regulation. The PGOOD logic monitors EN_DELAY, SS_DELAY, and under/over voltage fault signals. PGOOD is released only when EN_DELAY and SS_DELAY = HIGH and output voltage is within the OV and UV thresholds.

PRE-BIAS STARTUP

IR3475 is able to start up into pre-charged output, which prevents oscillation and disturbances of the output voltage.

With constant on-time control, the output voltage is compared with the soft start voltage (SS) or Vref, depending on which one is lower, and will not start switching unless the output voltage drops below the reference. This scheme prevents discharge of a pre-biased output voltage.

SHUTDOWN

The IR3475 will shutdown if VCC is below its UVLO limit. The IR3475 can be shutdown by pulling the EN pin below its lower threshold. Alternatively, the output can be shutdown by pulling the soft start pin below 0.3V.

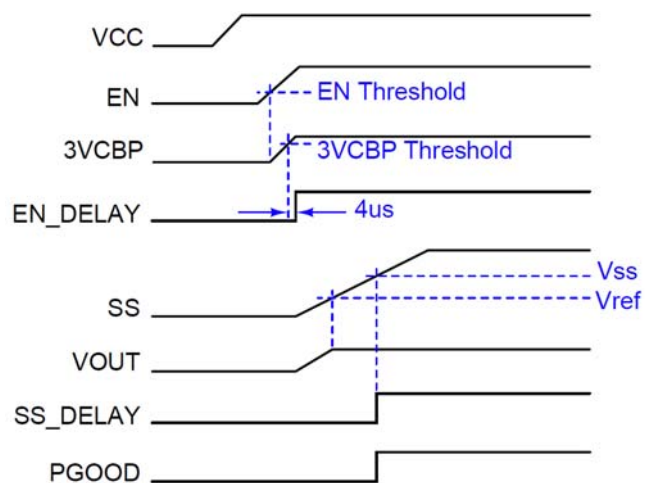

Figure 23: Normal Startup

UNDER/OVER VOLTAGE MONITOR

The IR3475 monitors the voltage at the FB node through a 350ns filter. If the FB voltage is below the under voltage threshold, UV# is set to LOW holding PGOOD to be LOW. If the FB voltage is above the over voltage threshold, OV# is set to LOW, the shutdown signal (SD) is set to HIGH, MOSFET gates are turned off, and PGOOD signal is pulled low. Toggling VCC or EN will allow the next start up. Figure 24 and 25 show PGOOD status change when UV/OV is detected. The over voltage and under voltage thresholds can be found in the Electrical Specification section.

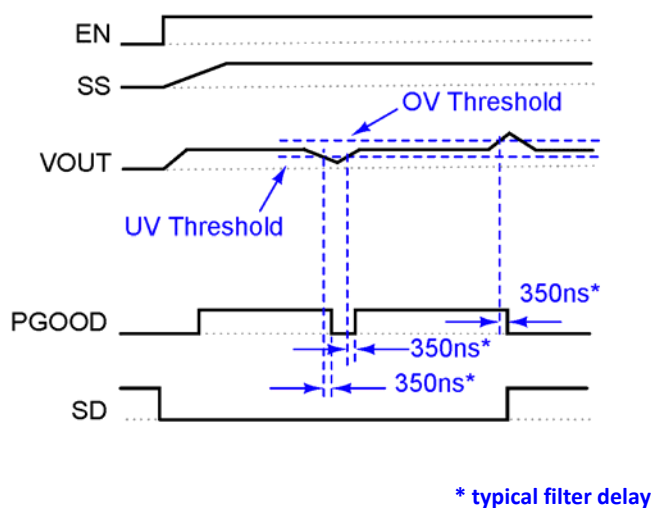

Figure 24: Under/Over Voltage Monitor

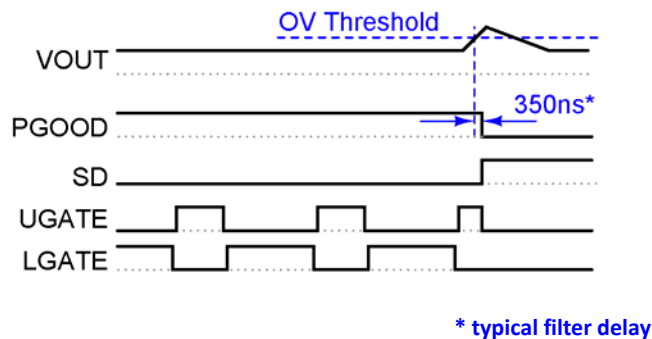

Figure 25: Over Voltage Protection

OVER CURRENT MONITOR

The over-current circuitry monitors the output current during each switching cycle. The voltage across the lower

MOSFET, VPHASE, is monitored for over current and zero crossing. The OCP circuit evaluates VPHASE for an over current condition typically 270ns after the lower MOSFET is gated on. This delay functions to filter out switching noise. The minimum lower gate interval allows time to sample VPHASE.

The over current trip point is programmed with a resistor from the ISET pin to PHASE pin, as shown in equation 4. When over current is detected, the MOSFET gates are tri-state and SS voltage is pulled to 0V. This initiates a new soft start cycle. If there is a total of four OC events, the IR3475 will disable switching. Toggling VCC or EN will allow the next start up.

$$R_{SET} = \frac{R_{DSON} \cdot I_{OC}}{19 \mu A} \quad (4)$$

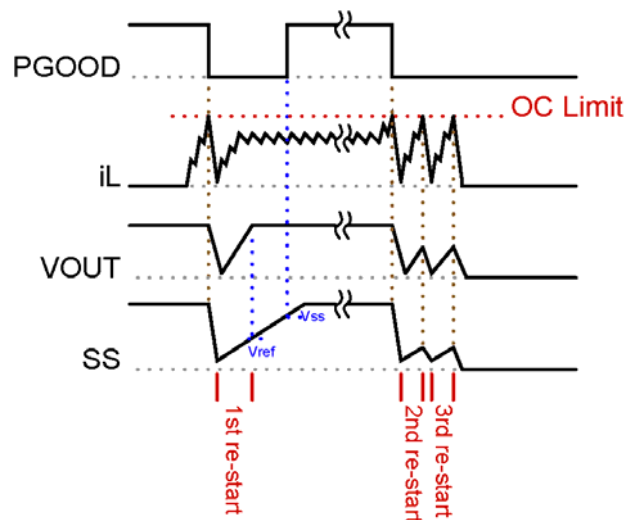

Figure 26: Over Current Protection

UNDER VOLTAGE LOCK-OUT

The IR3475 has VCC and EN under voltage lock-out (UVLO) protection. When either VCC or EN is below their UVLO threshold, IR3475 is disabled. IR3475 will restart when both VCC and EN are above their UVLO thresholds.

OVER TEMPERATURE PROTECTION

When the IR3475 exceeds its over temperature threshold, the MOSFET gates are tri-state and PGOOD is pulled low. Switching resumes once temperature drops below the over temperature hysteresis level.

GATE DRIVE LOGIC

The gate drive logic features adaptive dead time, diode emulation, and a minimum lower gate interval.

An adaptive dead time prevents the simultaneous conduction of the upper and lower MOSFETs. The lower gate voltage must be below approximately 1V after PWM goes HIGH before the upper MOSFET can be gated on. Also, the differential voltage between the upper gate and PHASE must be below approximately 1V after PWM goes LOW before the lower MOSFET can be gated on.

The upper MOSFET is gated on after the adaptive delay for PWM = HIGH and the lower MOSFET is gated on after the adaptive delay for PWM = LOW. When FCCM = LOW, the lower MOSFET is driven 'off' when the ZCROSS signal indicates that the inductor current is about to reverse direction. The ZCROSS comparator monitors the PHASE voltage to determine when to turn off the lower MOSFET. The lower MOSFET stays 'off' until the next PWM falling edge. When the lower peak of the inductor current is above zero, IR3475 operates in continuous conduction mode. The continuous conduction mode can also be selected for all load current levels by pulling FCCM to HIGH.

Whenever the upper MOSFET is turned 'off', it stays 'off' for the *Min Off Time* denoted in the *Electrical Specifications*. This minimum duration allows time to recharge the bootstrap capacitor and allows the over current monitor to sample the PHASE voltage.

COMPONENT SELECTION

Selection of components for the converter is an iterative process which involves meeting the specifications and tradeoffs between performance and cost. The following sections will guide one through the process.

Inductor Selection

Inductor selection involves meeting the steady state output ripple requirement, minimizing the switching loss of the upper MOSFET, meeting transient response specifications and minimizing the output capacitance. The output voltage includes a DC voltage and a small AC ripple component due to the low pass filter which has incomplete attenuation of the switching harmonics. Neglecting the inductance in series with the output

capacitor, the magnitude of the AC voltage ripple is determined by the total inductor ripple current flowing through the total equivalent series resistance (ESR) of the output capacitor bank.

One can use equation 5 to find the required inductance. ΔI is defined as shown in Figure 27. The main advantage of small inductance is increased inductor current slew rate during a load transient, which leads to a smaller output capacitance requirement as discussed in the *Output Capacitor Selection* section. The drawback of using smaller inductances is increased switching power loss in the upper MOSFET, which reduces the system efficiency and increases the thermal dissipation.

$$\Delta I = \frac{T_{ON} \cdot (V_{IN} - V_{OUT})}{2 \cdot L} \quad (5)$$

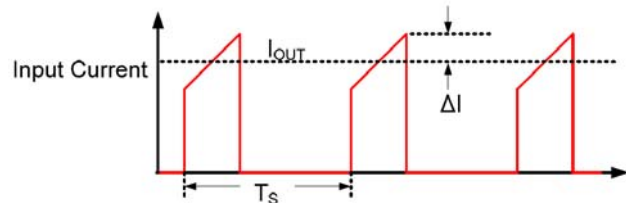

Figure 27: Typical Input Current Waveform

Input Capacitor Selection

The main function of the input capacitor bank is to provide the input ripple current and fast slew rate current during the load current step up. The input capacitor bank must have adequate ripple current carrying capability to handle the total RMS current. Figure 27 shows a typical input current. Equation 6 shows the RMS input current.

The RMS input current contains the DC load current and the inductor ripple current. As shown in equation 5, the inductor ripple current is unrelated to the load current. The maximum RMS input current occurs at the maximum output current. The maximum power dissipation in the input capacitor equals the square of the maximum RMS input current times the input capacitor's total ESR.

$$\begin{aligned} I_{IN_RMS} &= \sqrt{\frac{1}{T_S} \cdot \int_0^{T_S} f^2(t) \cdot dt} \\ &= I_{OUT} \cdot \sqrt{T_{ON} \cdot F_S} \cdot \sqrt{1 + \frac{1}{3} \cdot \left(\frac{\Delta I}{I_{OUT}}\right)^2} \quad (6) \end{aligned}$$

The voltage rating of the input capacitor needs to be greater than the maximum input voltage because of high frequency ringing at the phase node. The typical percentage is 25%.

Output Capacitor Selection

Selection of the output capacitor requires meeting voltage overshoot requirements during load removal, and meeting steady state output ripple voltage requirements. The output capacitor is the most expensive converter component and increases the overall system cost. The output capacitor decoupling in the converter typically includes the low frequency capacitor, such as Specialty Polymer Aluminum, and mid frequency ceramic capacitors.

The first purpose of output capacitors is to provide current when the load demand exceeds the inductor current, as shown in Figure 28. Equation 7 shows the charge requirement for a certain load step. The advantage provided by the IR3475 at a load step is the reduced delay compared to a fixed frequency control method. If the load increases right after the PWM signal goes low, the longest delay will be equal to the minimum lower gate on-time as shown in the *Electrical Specifications* section. The IR3475 also reduces the inductor current slew time, the time it takes for the inductor current to reach equality with the output current, by increasing the switching frequency up to $1/(T_{ON} + \text{Min Off Time})$. This results in reduced recovery time.

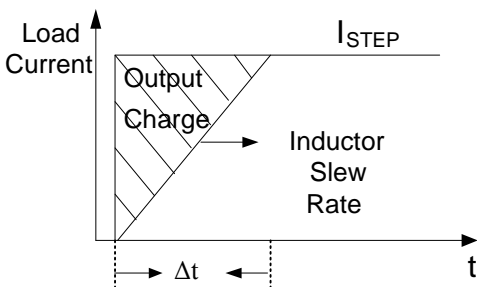

Figure 28: Charge Requirement during Load Step

$$Q = C \cdot V = 0.5 \cdot I_{STEP} \cdot \Delta t \quad (7a)$$

$$C_{OUT} = \frac{1}{V_{DROP}} \left[\frac{1}{2} \cdot \frac{L \cdot I_{STEP}^2}{(V_{IN} - V_{OUT})} \right] \quad (7b)$$

The output voltage drop, V_{DROP} , initially depends on the characteristic of the output capacitor. V_{DROP} is the sum of the equivalent series inductance (ESL) of the output capacitor times the rate of change of the output current and the ESR times the change of the output current.

V_{ESR} is usually much greater than V_{ESL} . The IR3475 requires a total ESR such that the ripple voltage at the FB pin is greater than 7mV.

The second purpose of the output capacitor is to minimize the overshoot of the output voltage when the load decreases as shown in Figure 29. By using the law of energy before and after the load removal, equation 8 shows the output capacitance requirement for a load step down.

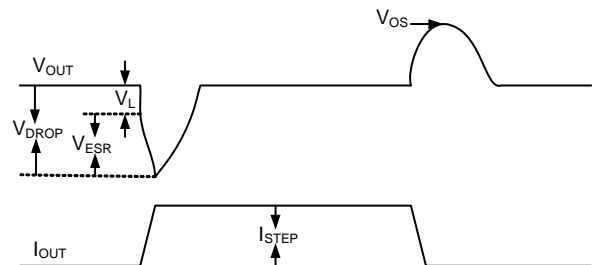

Figure 29: Typical Output Voltage Response Waveform

$$C_{OUT} = \frac{L \cdot I_{STEP}^2}{V_{OS}^2 - V_{OUT}^2} \quad (8)$$

Boot Capacitor Selection

The boot capacitor starts the cycle fully charged to a voltage of $V_B(0)$. C_g equals 0.58nF in IR3475. Choose a sufficiently small ΔV such that $V_B(0) - \Delta V$ exceeds the maximum gate threshold voltage to turn on the upper MOSFET.

$$C_{BOOT} = C_g \cdot \left(\frac{V_B(0)}{\Delta V} - 1 \right) \quad (9)$$

Choose a boot capacitor value larger than the calculated C_{BOOT} in equation 9. Equation 9 is based on charge balance at CCM operation. Usually the boot capacitor will be discharged to a much lower voltage when the circuit is operating in DCM mode at light load, due to much longer lower MOSFET off time and the bias current drawn by the IC. Boot capacitance needs to be increased if insufficient turn-on of the upper MOSFET is observed at light load, typically larger than 0.1 μ F is needed. The voltage rating of this part needs to be larger than $V_B(0)$ plus the desired derating voltage. It's ESR and ESL needs to be low in order to allow it to deliver the large current and di/dt 's which drive MOSFETs most efficiently. In support of these requirements a ceramic capacitor should be chosen.

DESIGN EXAMPLE

DESIGN CRITERIA

- Input Voltage, $V_{IN} = 6V$ to $21V$
- Output Voltage, $V_{OUT} = 1.25V$
- Switching Frequency, $F_s = 400kHz$
- Inductor Ripple Current, $2\Delta I = 2.5A$
- Maximum Output Current, $I_{OUT} = 10A$
- Over Current Trip, $IOC = 15A$
- Current Transient Step Size = $4A$
- Overshoot Allowance, $VOS = V_{OUT} + 50mV$
- Undershoot Allowance, $V_{DROP} = 50mV$

Find R_{FF} :

$$R_{FF} = \frac{1.25V}{1V \cdot 20pF \cdot 400kHz} = 156k\Omega$$

Pick a standard value $158k\Omega$, 1% resistor.

Find R_{SET} :

$$R_{SET} = \frac{13m\Omega \cdot 15A}{19\mu A} = 10.3k\Omega$$

Pick a $10.5k\Omega$, 1% standard resistor.

Find a resistive voltage divider for $V_{OUT} = 1.25V$:

$$V_{FB} = \frac{R_2}{R_2 + R_1} \cdot V_{OUT} = 0.5V$$

$R_2 = 1.33k\Omega$, $R_1 = 1.96k\Omega$, both 1% standard resistors.

Choose the soft start capacitor:

Once the soft start time has chosen, such as $1000\mu s$ to reach to the reference voltage, a $22nF$ for C_{SS} is used to meet $1000\mu s$.

Choose an inductor to meet the design specification:

$$\begin{aligned} L &= \frac{V_{OUT} \cdot (V_{IN} - V_{OUT})}{V_{IN} \cdot 2\Delta I \cdot F_s} \\ &= \frac{1.25V \cdot (21V - 1.25V)}{21V \cdot 2.5A \cdot 400kHz} \\ &= 1.18\mu H \end{aligned}$$

Choose the inductor with the lowest DCR and AC power

loss as possible to increase the overall system efficiency.

For instance, choose a PIMB104T-1R5MS-39 manufactured by CYNTEC. The inductance of this part is $1.5\mu H$ and has $3.8m\Omega$ DCR. Ripple current needs to be recalculated using the chosen inductor.

$$2\Delta I = \frac{1.25V \cdot (21V - 1.25V)}{21V \cdot 1.5\mu H \cdot 400kHz} = 2A$$

Choose an input capacitor:

$$I_{IN_RMS} = 10A \cdot \sqrt{\frac{1.25V}{21V}} \cdot \sqrt{1 + \frac{1}{3} \cdot \left(\frac{1A}{10A}\right)^2} = 2.4A$$

A Panasonic $10\mu F$ (ECJ3YB1E106M) accommodates 6 Arms of ripple current at $300kHz$. Due to the chemistry of multilayer ceramic capacitors, the capacitance varies over temperature and operating voltage, both AC and DC. One $10\mu F$ capacitor is recommended. In a practical solution, one $1\mu F$ capacitor is required along with $10\mu F$. The purpose of the $1\mu F$ capacitor is to suppress the switching noise and deliver high frequency current.

Choose an output capacitor:

To meet the undershoot and overshoot specification, equations 7b and 8 will be used to calculate the minimum output capacitance. As a result, $190\mu F$ will be needed for $4A$ load removal. To meet the stability requirement, choose an output capacitor with ESR larger than $9m\Omega$. Combine those two requirements, one can choose a set of output capacitors from manufactures such as SP-Cap (Specialty Polymer Capacitor) from Panasonic or POSCAP from Sanyo. A $220\mu F$ (4TPE220MIC2) from Sanyo with $18m\Omega$ ESR will meet both requirements.

If an all ceramic output capacitor solution is desired, the external slope injection circuit composed of R_6 , C_{13} , and C_{14} is required as explained in the *Stability Considerations* section. In this design example, we can choose $C_{14} = 1nF$ and $C_{13} = 100nF$. To calculate the value of R_6 with PIMB104T-1R5MS-39 as our inductor:

$$\begin{aligned} R_6 &= \frac{L}{DCR \cdot C_{13}} \\ &= \frac{1.5\mu H}{3.8m\Omega \cdot 100nF} \\ &= 3.95k\Omega \end{aligned}$$

Pick a standard value for $R_6 = 3.92k\Omega$.

STABILITY CONSIDERATIONS

Constant-on-time control is a fast, ripple based control scheme. Unstable operation can occur if certain conditions are not met. The system instability is usually caused by:

Switching noise coupled to FB input:

This causes the PWM comparator to trigger prematurely after the 500ns minimum on-time for lower MOSFET. It will result in double or multiple pulses every switching cycle instead of the expected single pulse. Double pulsing can cause higher output voltage ripple, but in most applications it will not affect operation. This can usually be prevented by careful layout of the ground plane and the FB sensing trace.

Steady state ripple on FB pin being too small:

The PWM comparator in IR3475 requires a minimum 7mVp-p ripple voltage to operate stably. Not enough ripple will result in similar double pulsing issues described above. Solving this may require using output capacitors with higher ESR.

ESR loop instability:

The stability criteria of constant on-time is:

$$ESR \cdot C_{OUT} > T_{ON} / 2$$

If ESR is too small that this criteria is violated then sub-harmonic oscillation will occur. This is similar to the instability problem of peak-current-mode control with $D > 0.5$. Increasing ESR is the most effective way to stabilize the system, but the tradeoff is the larger output voltage ripple.

System with all ceramic output capacitors:

For applications with all ceramic output capacitors, the ESR is usually too small to meet the stability criteria. In these applications, external slope compensation is necessary to make the loop stable. The ramp injection circuit, composed of R6, C13, and C14, shown in Figure 4 is required. The inductor current ripple sensed by R6 and C13 is AC coupled to the FB pin through C14. C14 is usually chosen between 1 to 10nF, and C13 between 10 to 100nF. R6 should then be chosen such that $L/DCR = C13 \cdot R6$.

LAYOUT RECOMMENDATIONS

Bypass Capacitor:

As VCC bypass capacitor, a 1µF high quality ceramic capacitor should be placed on the same side as the IR3475 and connected to VCC and PGND pins directly. A 1µF ceramic capacitor should be connected from 3VCCBP to GND to avoid noise coupling into controller circuits. For single-ground designs, a resistor (R12) in the range of 5 to 10Ω in series with the 1µF capacitor as shown in Figure 4 is recommended.

Boot Circuit:

C_{BOOT} should be placed near the BOOT and PHASE pins to reduce the impedance when the upper MOSFET turns on.

Power Stage:

Figure 30 shows the current paths and their directions for the on and off periods. The on-time path has low average DC current and high AC current. Therefore, it is recommended to place the input ceramic capacitor, upper, and lower MOSFET in a tight loop as shown in Figure 30.

The purpose of the tight loop from the input ceramic capacitor is to suppress the high frequency (10MHz range) switching noise and reduce Electromagnetic Interference (EMI). If this path has high inductance, the circuit will cause voltage spikes and ringing, and increase the switching loss. The off-time path has low AC and high average DC current. Therefore, it should be laid out with a tight loop and wide trace at both ends of the inductor. Lowering the loop resistance reduces the power loss. The typical resistance value of 1-ounce copper thickness is 0.5mΩ per square inch.

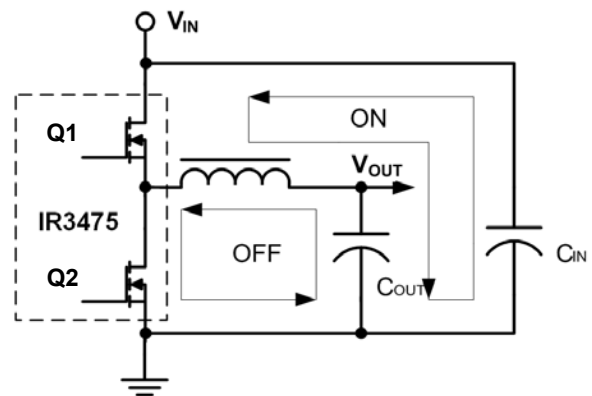
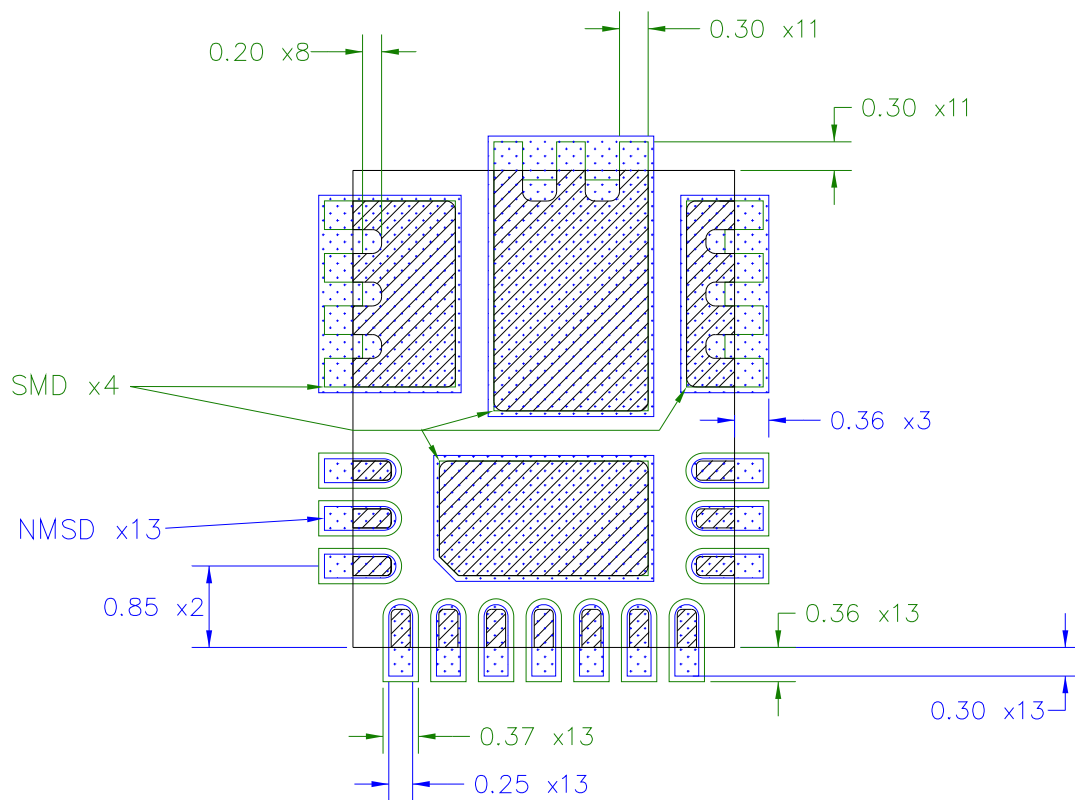

Figure 30: Current Path of Power Stage

PCB METAL AND COMPONENT PLACEMENT

- Lead lands (the 13 IC pins) width should be equal to nominal part lead width. The minimum lead to lead spacing should be $\geq 0.2\text{mm}$ to minimize shorting.
- Lead land length should be equal to maximum part lead length + 0.3 mm outboard extension. The outboard extension ensures a large toe fillet that can be easily inspected.
- Pad lands (the 4 big pads) length and width should be equal to maximum part pad length and width. However, the minimum metal to metal spacing should be no less than; 0.17mm for 2 oz. Copper or no less than 0.1mm for 1 oz. Copper or no less than 0.23mm for 3 oz. Copper.



All Dimensions in mm

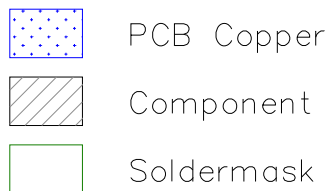

Figure 31: Metal and Component Placement

* Contact International Rectifier to receive an electronic PCB Library file in your preferred format

SOLDER RESIST

- It is recommended that the lead lands are Non Solder Mask Defined (NSMD). The solder resist should be pulled away from the metal lead lands by a minimum of 0.025mm to ensure NSMD pads.
- The land pad should be Solder Mask Defined (SMD), with a minimum overlap of the solder resist onto the copper of 0.05mm to accommodate solder resist misalignment.
- Ensure that the solder resist in between the lead lands and the pad land is $\geq 0.15\text{mm}$ due to the high aspect ratio of the solder resist strip separating the lead lands from the pad land.

All Dimensions in mm

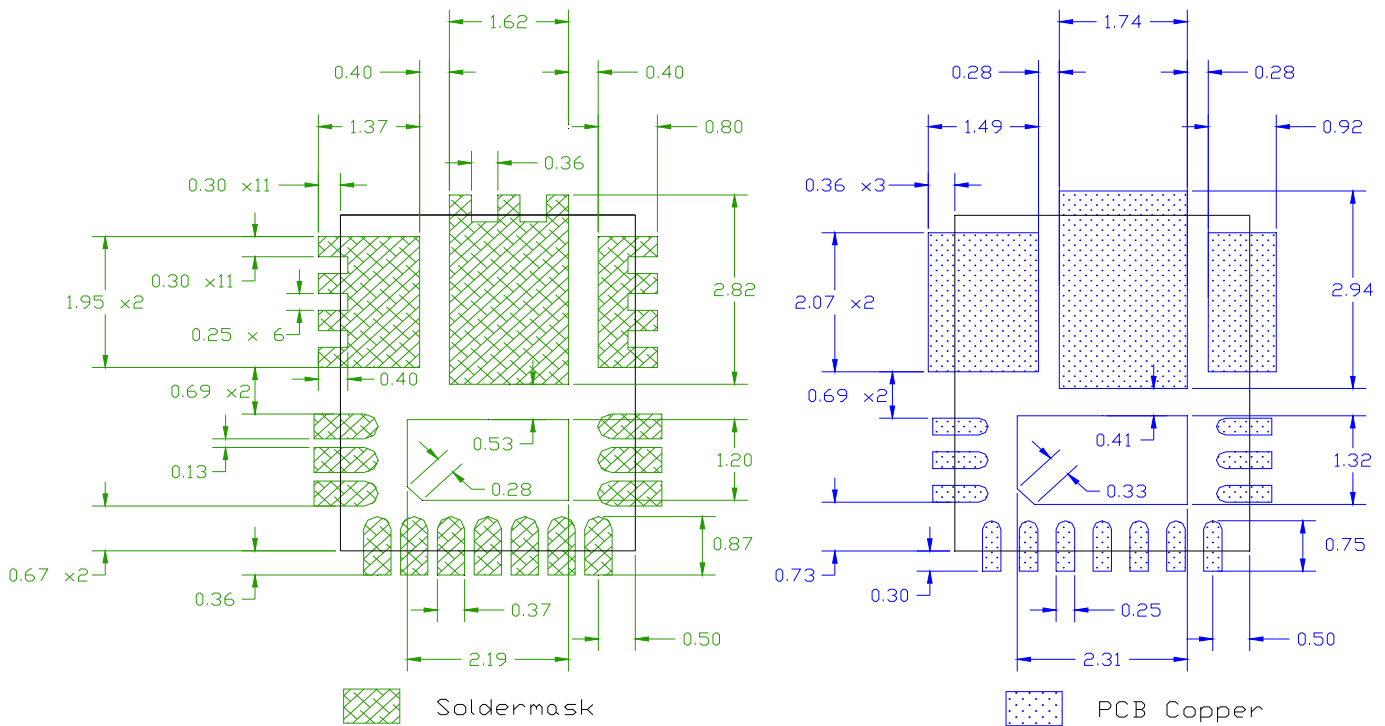
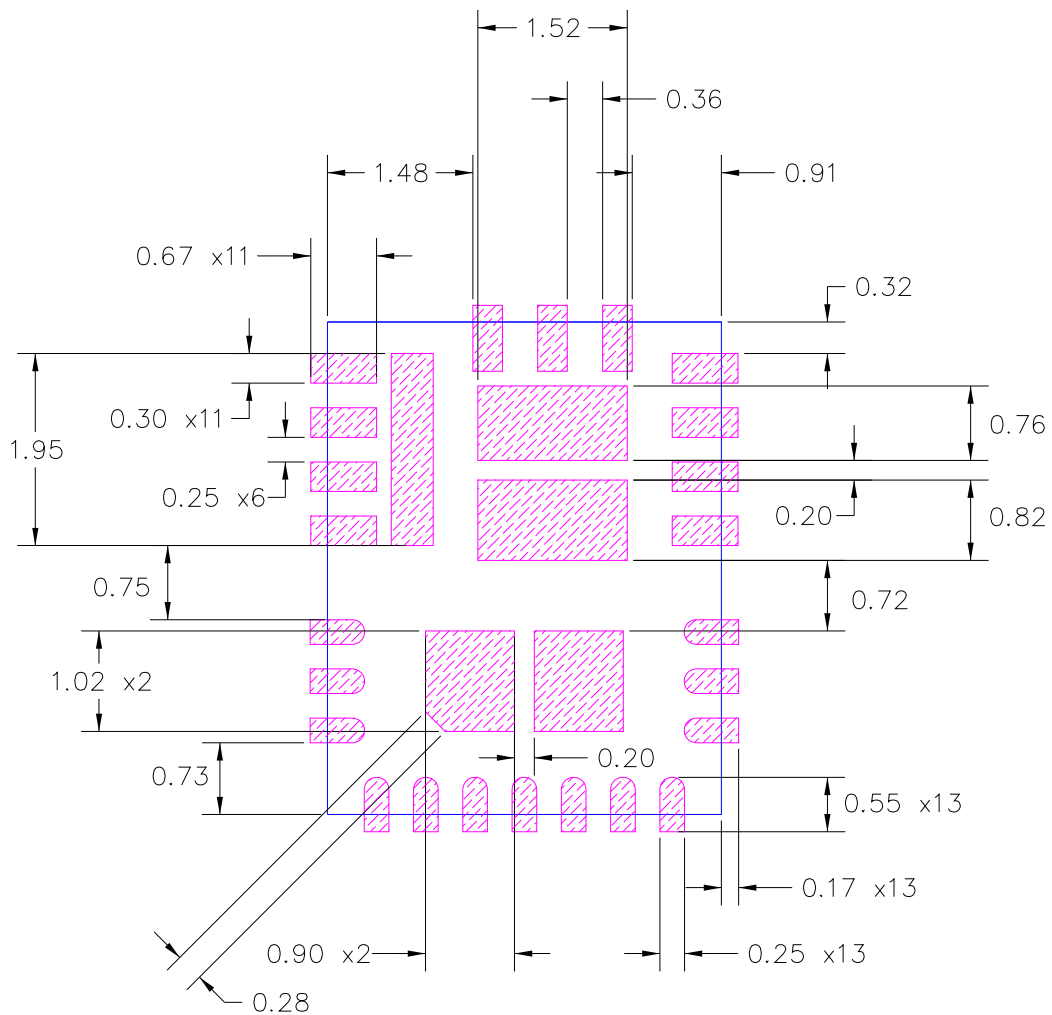

Figure 32: Solder Resist

* Contact International Rectifier to receive an electronic PCB Library file in your preferred format

STENCIL DESIGN

- The Stencil apertures for the lead lands should be approximately 80% of the area of the lead lads. Reducing the amount of solder deposited will minimize the occurrences of lead shorts. If too much solder is deposited on the center pad the part will float and the lead lands will open.
- The maximum length and width of the land pad stencil aperture should be equal to the solder resist opening minus an annular 0.2mm pull back in order to decrease the risk of shorting the center land to the lead lands when the part is pushed into the solder paste.



Stencil Aperture
 All Dimensions in mm

Figure 33: Stencil Design

* Contact International Rectifier to receive an electronic PCB Library file in your preferred format

PACKAGE INFORMATION

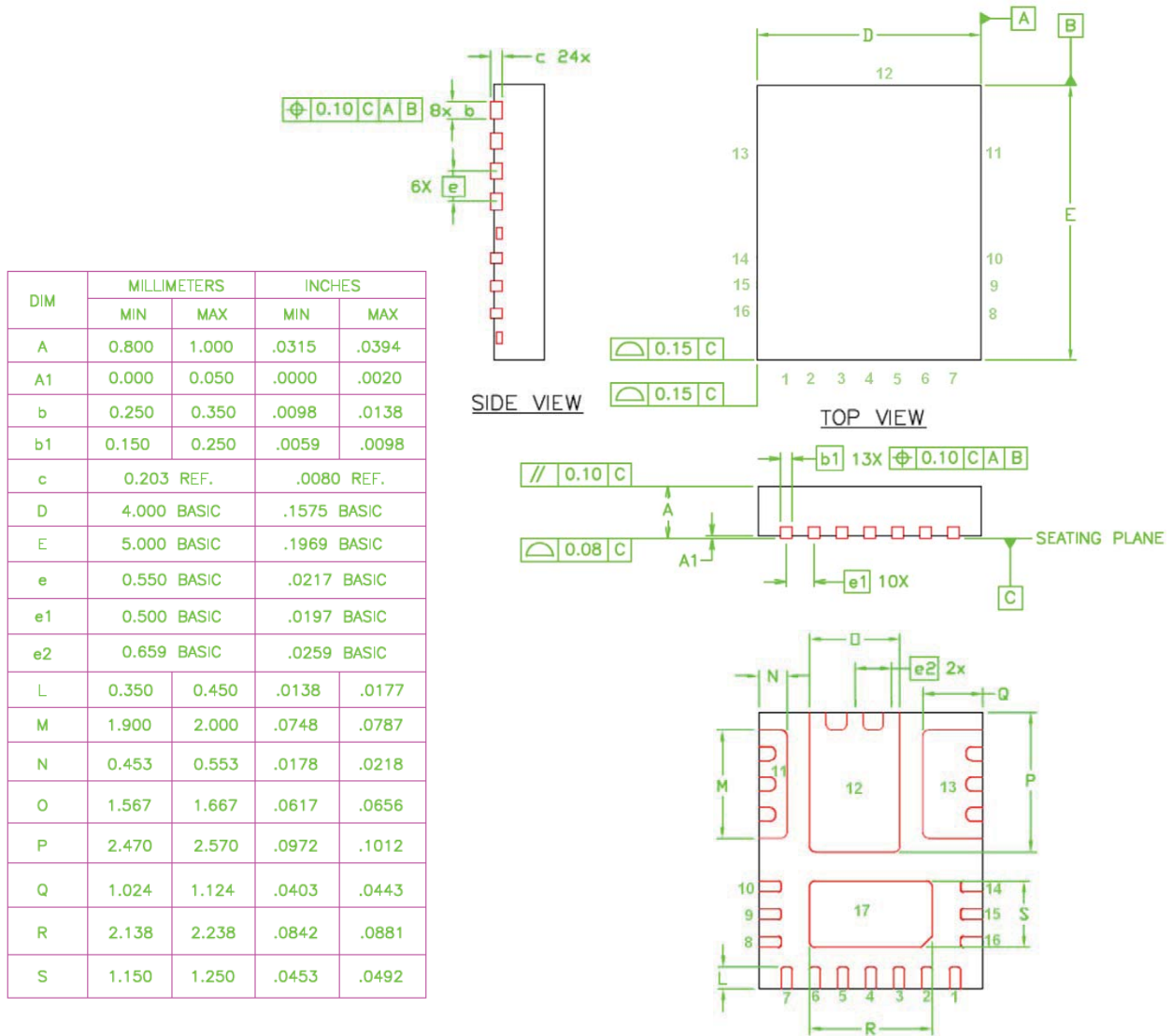

Figure 34: Package Dimensions

Data and specifications subject to change without notice.
This product has been designed and qualified for the Industrial Market (Note2).
Qualification Standards can be found on IR's Web site.