

IR3702/IR3702N

General Purpose Quad

Operational Amplifier

■ Description

The IR3702/IR3702N is a general purpose high gain frequency compensated quad operational amplifier, which operates from a single supply over a wide range of voltages.

■ Features

1. Operate from a single power supply
2. No frequency compensation required
3. Input common-mode voltage range includes ground
4. 14-pin dual-in-line package (IR3702)
14-pin small-outline package (IR3702N)

■ Pin Connections

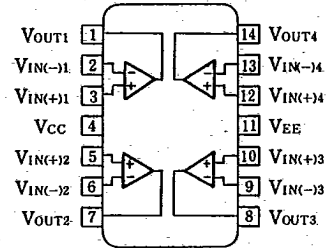

Top View

www.DataSheet4U.com

■ Equivalent Circuit

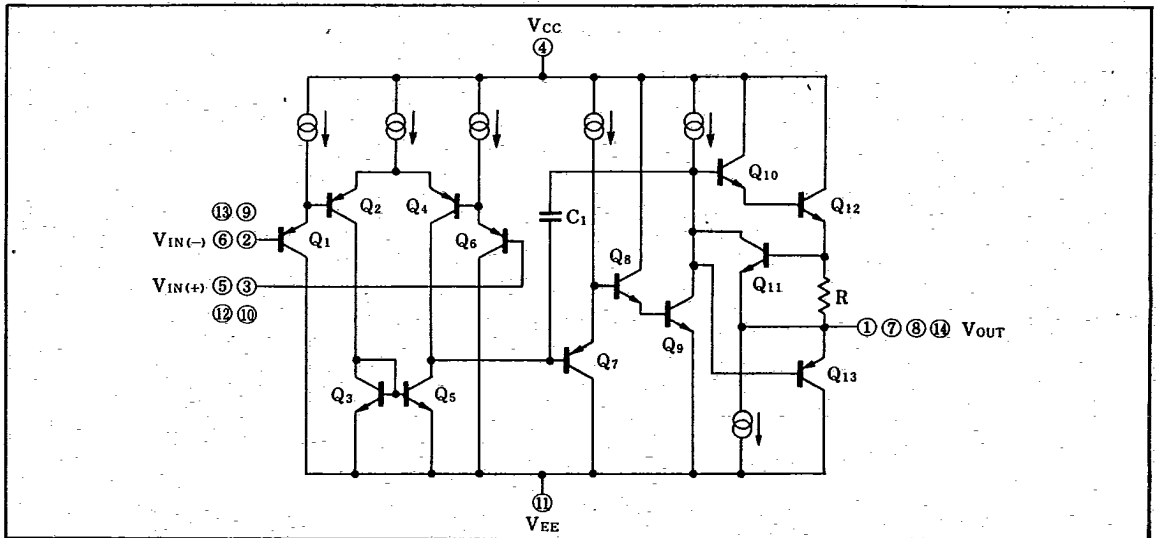

www.DataSheet4U.com

SHARP

(Ta=25°C)

Absolute Maximum Ratings

Parameter	Symbol	Condition		Rating	Unit
Supply voltage	$V_{CC}-V_{EE}$			36	V
Differential input voltage	V_{ID}			$V_{EE}\sim V_{CC}$	V
In-phase input voltage	V_{ICM}			$(V_{EE}-0.3)\sim V_{CC}$	V
Power dissipation	P_D	$T_a\leq 25^\circ\text{C}$	IR3702	650	mW
			IR3702N	625	
P_D derating ratio	$\Delta P_D/^\circ\text{C}$	$T_a>25^\circ\text{C}$	IR3702	6.5	mW/°C
			IR3702N	5	
Operating temperature	T_{opr}			-30~+85	°C
Storage temperature	T_{stg}			-40~+125	°C
				-55~+150	

Electrical Characteristics

(V_{CC}=8V, V_{EE}=-8V, T_a=25°C)

Parameter	Symbol	Condition	MIN.	TYP.	MAX.	Unit
Input offset voltage	V_{IO}	$R_S=50\Omega$		2	7	mV
Input offset current	I_{IO}			±5	±50	nA
Input bias current	I_B			50	500	nA
In-phase input voltage	V_{ICM}		V_{EE}		$V_{CC}-1.5$	V
Major amplitude voltage gain	A_V	$R_L\geq 2k\Omega$	80	95		dB
Supply current	I_{CC}			1.2	3.0	mA
Common signal rejection ratio	CMR		70	85		dB
	SVR(+)		75	90		dB
Supply voltage rejection ratio	SVR(-)		70	84		
Maximum output voltage	$V_{OM}(+)$	$R_L=2k\Omega, V_{IN(+)}-V_{IN(-)}=1V$	6.0	6.4		V
	$V_{OM}(-)$	$R_L=2k\Omega, V_{IN(+)}-V_{IN(-)}=1V$		-7.4	-6.5	
Output source current	$I_{OS}(+)$	$V_{OUT}=0V, V_{IN(+)}-V_{IN(-)}=1V$	20	50		mA
Output sink current	$I_{OS}(-)$	$V_{OUT}=0V, V_{IN(-)}-V_{IN(+)}=1V$	10	25		
Slew rate	SR	$R_L=\infty$		0.6		V/μs
Channel separation	C.S			120		dB

Electrical Characteristic Curves (Unless otherwise specified, T_a=25°C)

Supply current—Supply voltage Characteristics

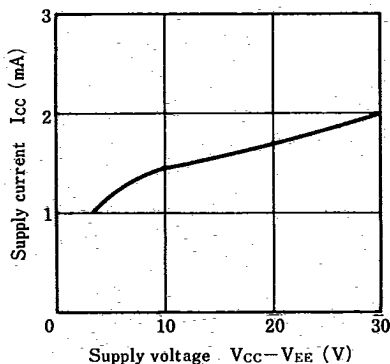

Voltage gain—Supply voltage Characteristics

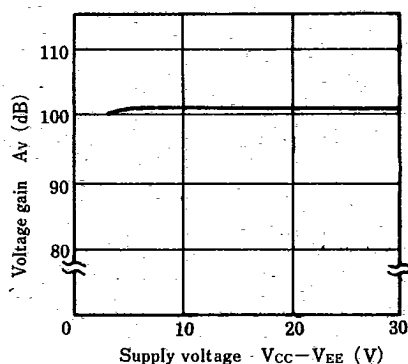

Input bias current—Supply voltage Characteristics

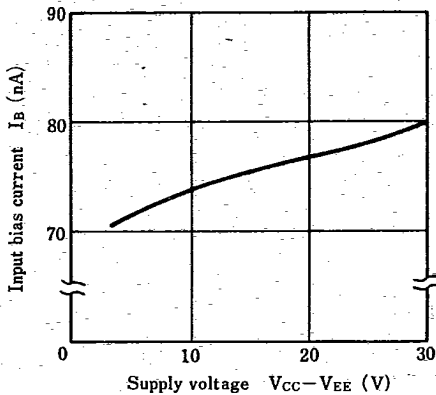

Maximum output current—Supply voltage Characteristics

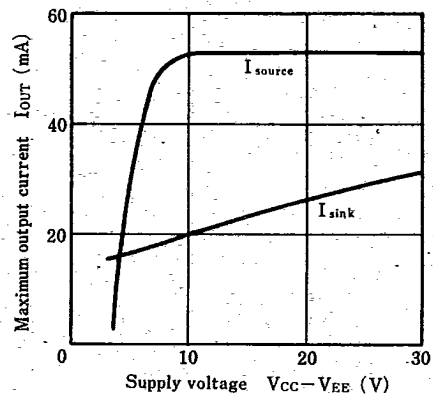

In-phase signal rejection ratio—Frequency Characteristics

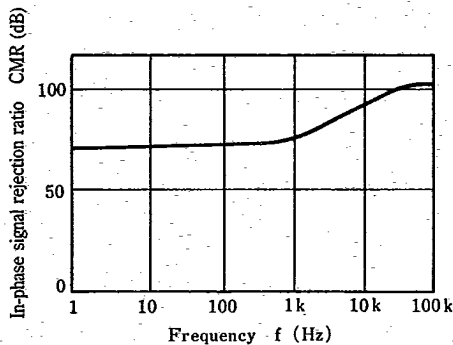

Open loop voltage gain—Frequency Characteristics

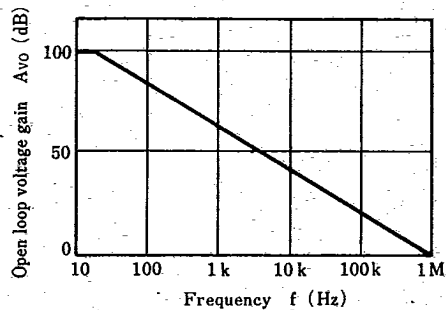

Major amplitude frequency Characteristics

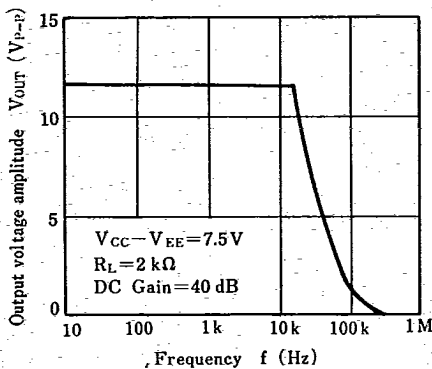

Response time Characteristics

