

# Infrared LED

MODEL NO : \_\_\_\_\_ IR908C \_\_\_\_\_

---

## ■ Features :

- Low forward voltage
- Peak wavelength  $\lambda_p=940\text{nm}$
- High reliability

## ■ Description :

- The IR908C is a GaAs(GaAlAs) infrared emitting diode. The miniature side-facing device is molded in a water clear plastic package.  
The device is spectrally matched with phototransistor.

## ■ Applications :

- Mouse
- Optoelectronic switch
- Floppy disk drive
- Photo interrupter

PART NO.	CHIP	LENS COLOR
	MATERIAL	
IR	GaAs(GaAlAs)	Water Clear

---

# Infrared LED

MODEL NO : IR908C

## Package Dimensions :

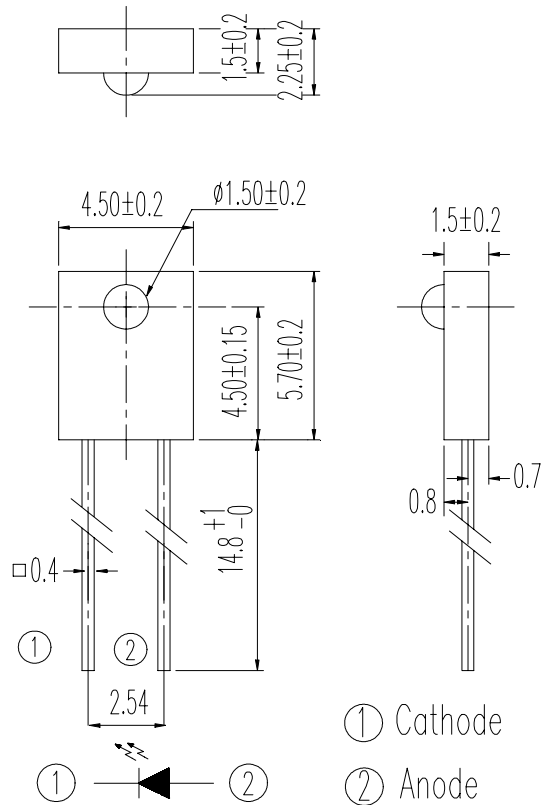

## Notes :

1. All dimensions are in millimeter.
2. General tolerance:  $\pm 0.1$  mm
3. Lead spacing is measured where the lead emerge from the package.
4. Lens color : Water clear.
5. Above specification may be changed without no will reserve authority on material change for above specification.
6. These specification sheets include materials protected under copyright of EVET corporation . Please don't reproduce or cause anyone to reproduce them without EVET's consent.
7. When using this product , please observe the absolute maximum ratings and the instructions for use outlined in these specification sheets. EVT assumes no responsibility for any damage resulting from use of the product which does not comply with the absolute maximum ratings and the instructions included in these specification sheets .

## Infrared LED

MODEL NO : IR908C

### ■ Absolute Maximum Ratings at $T_A = 25^\circ\text{C}$

Parameter	Symbol	Rating	Unit	Notice
Continuous Forward Current	$I_F$	50	mA	-
Peak Forward Current Pulse width=100 $\mu$ s, Duty cycle=1%	$I_{FP}$	1.0	A	-
Reverse Voltage	$V_R$	5	V	-
Operating Temperature	Topr	-25 ~ +85	$^\circ\text{C}$	-
Storage Temperature	Tstg	-40 ~ +85	$^\circ\text{C}$	-
Soldering Temperature	Tsol	260	$^\circ\text{C}$	-
Power Dissipation at(or below) 25 $^\circ\text{C}$ Free Air Temperature	Pd	75	mW	-

### ■ Electronic Optical Characteristics :

Parameter	Symbol	Min.	Typ.	Max.	Unit	Condition
Collector current	$I_{C(ON)}$	140	----	980	$\mu$ A	$V_{CE}=3.5V, I_F=4mA$
Peak Wavelength	$\lambda_P$	----	940	----	nm	$I_F=20mA$
Spectral Bandwidth	$\Delta \lambda$	----	50	----	nm	$I_F=20mA$
Forward Voltage	$V_F$	----	1.2	1.6	V	$I_F=20mA$
Reverse Current	$I_R$	----	----	10	$\mu$ A	$V_R=5V$
View Angle	$2\theta_{1/2}$	----	40	----	deg	$I_F=20mA$

# Infrared LED

MODEL NO : IR908C

## Typical Electrical/Optical/Characteristics Curves

Fig. 1 Forward Current vs. Ambient Temperature

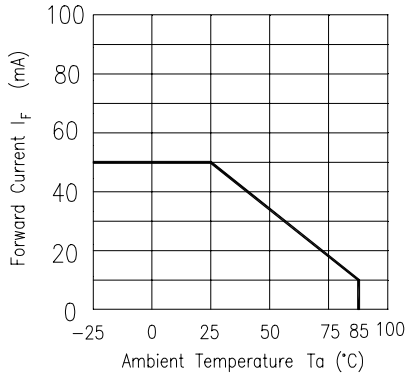

Fig. 2 Spectral Distribution

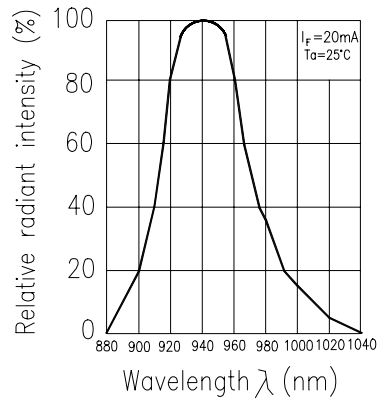

Fig. 3 Peak Emission Wavelength vs. Ambient Temperature

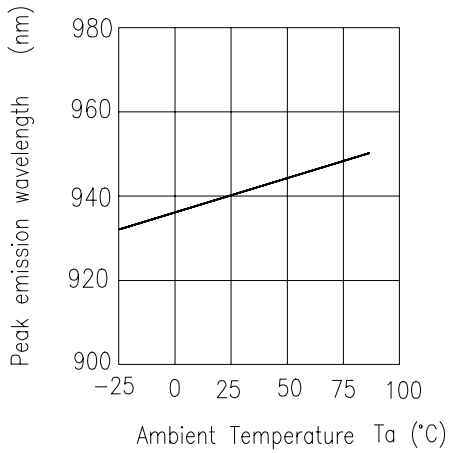

Fig. 4 Forward Current vs. Forward Voltage

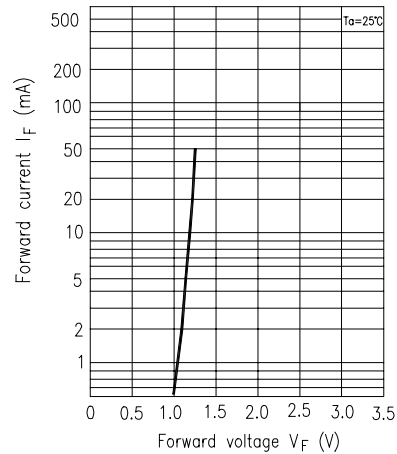

Fig. 5 Forward Voltage vs. Ambient Temperature

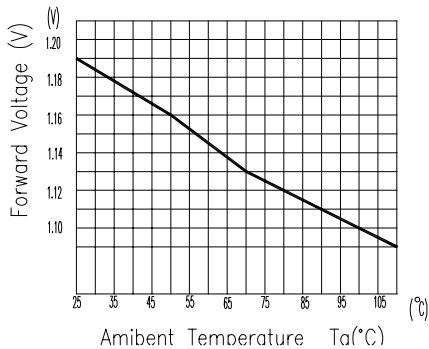
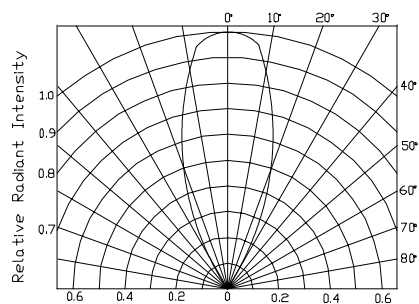

Fig. 6 Relative Radiant Intensity vs. Angular Displacement



# Infrared LED

MODEL NO : IR908C

## ■ Reliability Test Item And Condition

The reliability of products shall be satisfied with items listed below.

Confidence level:90%

LTPD:10%

NO.	Item	Test Conditions	Test Hours/ Cycles	Sample Size	Failure Judgement Criteria	Ac/Re
1	Solder Heat	TEMP : 260°C ± 5 °C	5 secs	22 pcs		0/1
2	Temperature Cycle	H : +85°C    30 mins ↑ 5 mins ↓ L : -55°C    30 mins	50 cycles	22 pcs	$I_R \geq U \times 2$ $I_{C(ON)} \leq L \times 0.8$ $V_F \geq U \times 1.2$	0/1
3	Thermal Shock	H : +100°C    5 mins ↑ 10 secs ↓ L : -10°C    5 mins	50 cycles	22 pcs	U :Upper specification limit L :Lower specification limit	0/1
4	High Temperature Storage	TEMP. : +100°C	1000 hrs	22 pcs		0/1
5	Low Temperature Storage	TEMP. : -55°C	1000 hrs	22 pcs		0/1
6	DC Operating Life	$I_F=20mA$	1000 hrs	22 pcs		0/1
7	High Temperature / High Humidity	85°C / 85% R.H.	1000 hrs	22 pcs		0/1

# Infrared LED

MODEL NO : IR908C

## Test Method For $I_{C(ON)}$ :

Condition :  $I_F=4\text{ mA}$

The intensity testing method for infrared emitting diode

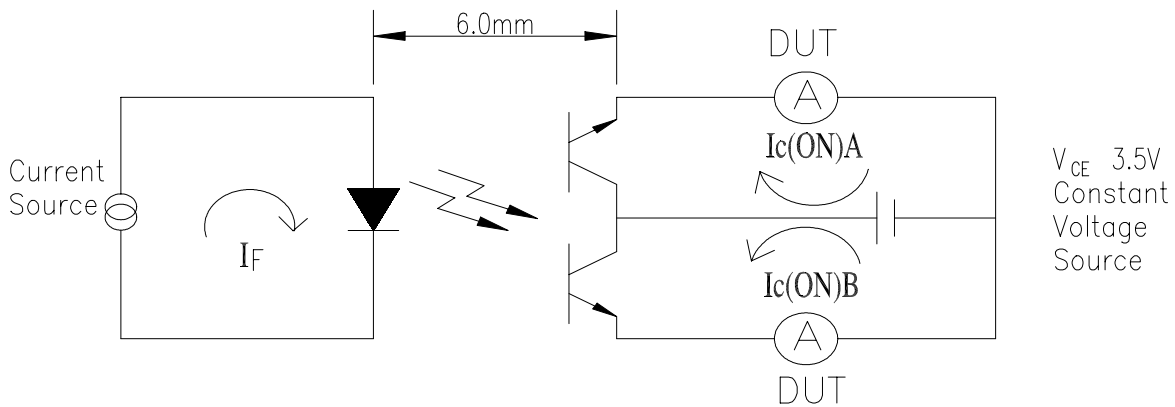

## To Distinguish Intensity:

Condition:  $I_F=4\text{mA}$ ,  $V_{CE}=3.5V$

### E Ranks

Color Code	Ranks	Min	Max	Unit
Red	E1	140	260	$\mu A$
Blue	E2	210	350	$\mu A$
Yellow	E3	280	440	$\mu A$
Silver	E4	350	530	$\mu A$
Green	E5	420	620	$\mu A$
Purple	E6	490	710	$\mu A$
White	E7	560	800	$\mu A$
Brown	E8	630	890	$\mu A$
Orange	E9	700	980	$\mu A$