

IR94558/IR94558N/IR94559/IR94559N

Low Noise Dual Operational Amplifier

Description

The IR94558/IR94558N and IR94559/IR94559N are low noise dual operational amplifiers. High input resistance, wide common mode input voltage range, and absence of latch-up make these amplifiers ideal for voltage-follower applications.

Features

1. No frequency compensation required
2. High input impedance $5M\Omega$ (TYP.)
3. Short circuit protected outputs
4. 8-pin dual-in-line package (IR94558/IR94559)
8-pin small-outline package (IR94558N/IR94559N)

Pin Connections

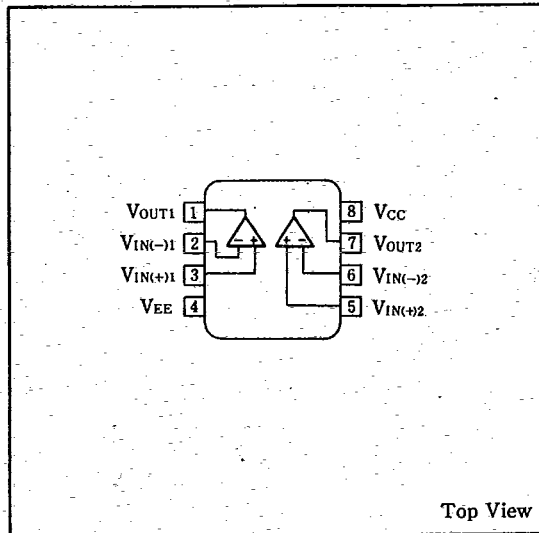

Equivalent Circuit

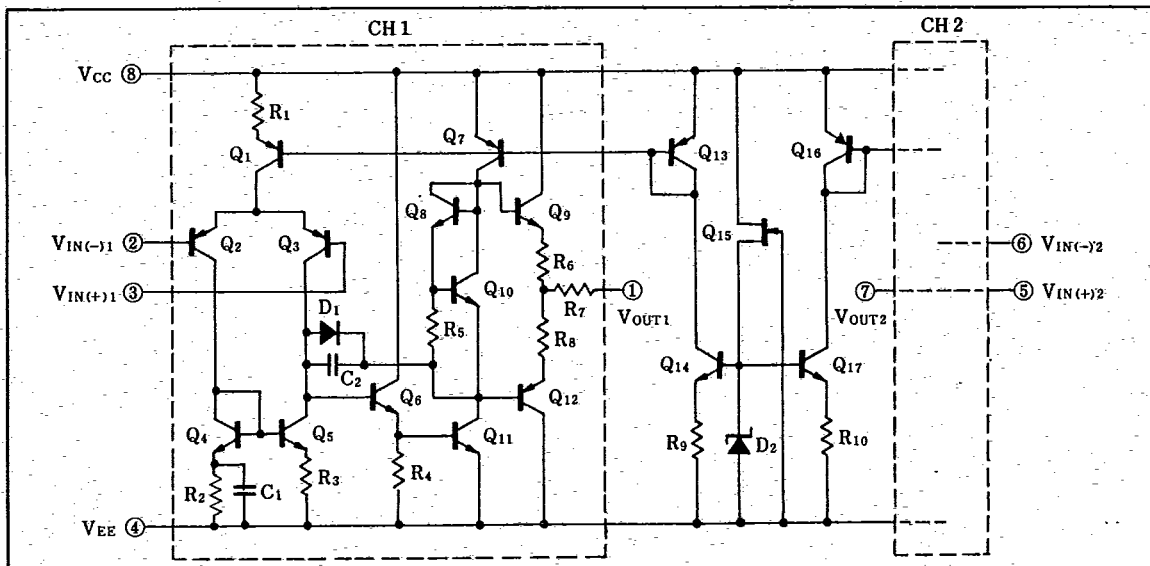

Absolute Maximum Ratings

(Ta=25°C)

Parameter	Symbol	Condition		Rating	Unit
Supply voltage	$V_{CC}-V_{EE}$			36	V
Differential input voltage	V_{ID}			±30	V
In-phase input voltage*1	V_{ICM}			±15	V
Power dissipation	P_D	$T_a \leq 25^\circ\text{C}$	IR94558/IR94559	500	mW
			IR94558N/IR94559N	500	
P_D derating ratio	$\Delta P_D/^\circ\text{C}$	$T_a > 25^\circ\text{C}$	IR94558/IR94559	5	mW/°C
			IR94558N/IR94559N	4	
Operating temperature	T_{opr}			-20~+75	°C
Storage temperature	T_{stg}			-55~+150	°C

Electrical Characteristics

($V_{CC}=15\text{V}$, $V_{EE}=-15\text{V}$, $T_a=25^\circ\text{C}$)

Parameter	Symbol	Condition	MIN.	TYP.	MAX.	Unit
Input offset voltage	V_{IO}	$R_S \leq 10\text{k}\Omega$		0.5	6	mV
Input offset current	I_{IO}			5	200	nA
Input bias current	I_B			40	500	nA
Input impedance	Z_{IN}		0.3	5		MΩ
In-phase input voltage	V_{ICM}		±12	±14		V
Major amplitude voltage gain	A_V	$R_L \geq 2\text{k}\Omega$, $V_{OUT} = \pm 10\text{V}$	86	110		dB
Maximum output voltage	V_{OM}	$R_L \geq 10\text{k}\Omega$	±12	±14		V
		$R_L \geq 2\text{k}\Omega$	±10	±13		
Common signal rejection ratio	CMR	$R_S \leq 10\text{k}\Omega$	70	90		dB
Supply voltage rejection ratio	SVR	$R_S \leq 10\text{k}\Omega$		30	150	μV/V
Power dissipation	P_D			105	170	mW
Input conversion noise voltage	V_{NI}	$R_S = 1\text{k}\Omega$, $BW = 10\text{Hz} \sim 30\text{kHz}$		2.5		μV _{rms}
Gain band product	G.B.	$R_L = 2\text{k}\Omega$	IR94558/IR94558N	3.0		MHz
			IR94559/IR94559N	6.0		
Slew rate	SR	$R_L \geq 2\text{k}\Omega$	IR94558/IR94558N	1.0		V/μs
			IR94559/IR94559N	2.0		

Electrical Characteristic Curves (Unless otherwise specified, $V_{CC}=15\text{V}$, $V_{EE}=-15\text{V}$, $T_a=25^\circ\text{C}$)

Input bias current—Ambient temperature Characteristics

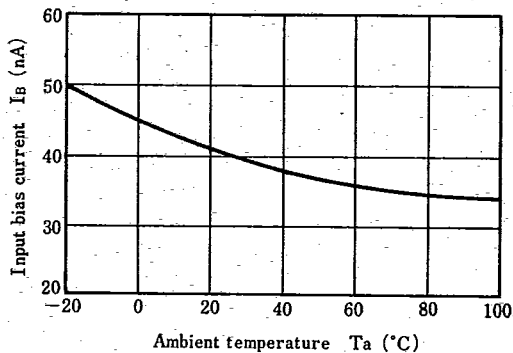

Maximum output amplitude voltage—Load resistance Characteristics

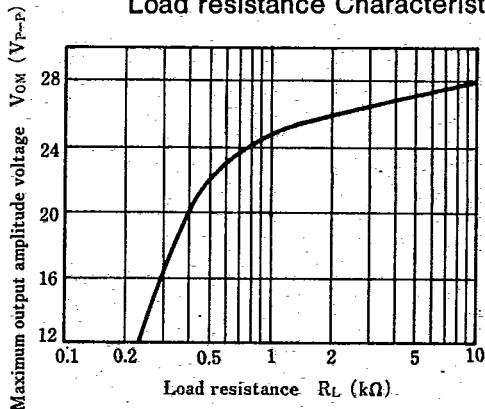

Maximum output voltage—Supply voltage Characteristics

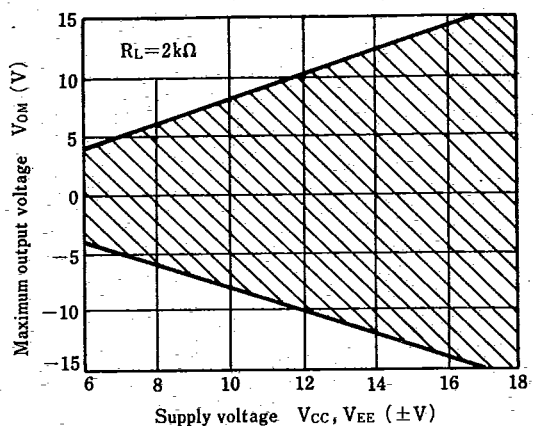

Input conversion noise voltage—Frequency Characteristics

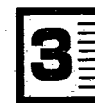
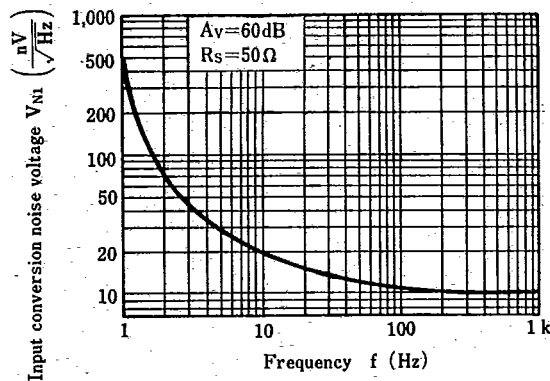

Open loop voltage gain—Frequency Characteristics

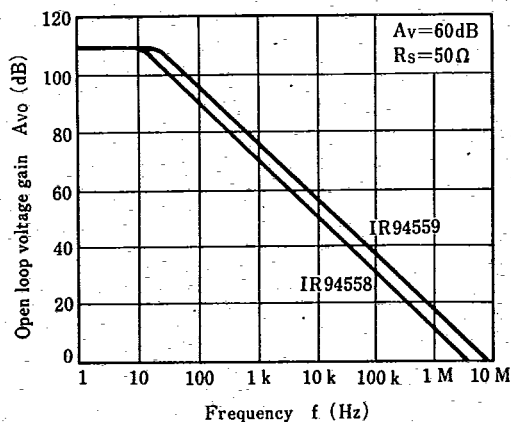

Maximum output amplitude voltage—Frequency Characteristics

