

## N-CHANNEL POWER MOSFETS

### FEATURES

- Low  $R_{DS(on)}$
- Improved inductive ruggedness
- Fast switching times
- Rugged polysilicon gate cell structure
- Low input capacitance
- Extended safe operating area
- Improved high temperature reliability
- TO-3 package (Standard)

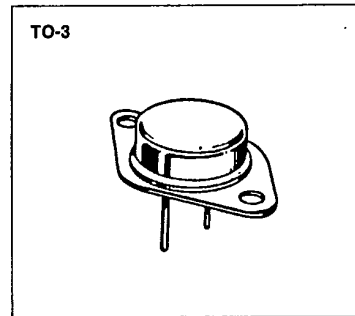

### PRODUCT SUMMARY

Part Number	$V_{DS}$	$R_{DS(on)}$	$I_D$
IRF340	400V	0.55 $\Omega$	10A
IRF341	350V	0.55 $\Omega$	10A
IRF342	400V	0.80 $\Omega$	8.0A
IRF343	350V	0.80 $\Omega$	8.0A

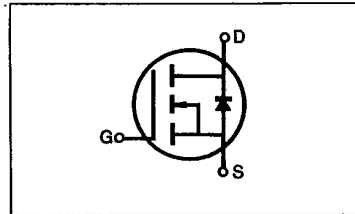

### MAXIMUM RATINGS

Characteristic	Symbol	IRF340	IRF341	IRF342	IRF343	Unit
Drain-Source Voltage (1)	$V_{DS}$	400	350	400	350	Vdc
Drain-Gate Voltage ( $R_{GS}=1.0M\Omega$ ) (1)	$V_{DGR}$	400	350	400	350	Vdc
Gate-Source Voltage	$V_{GS}$	$\pm 20$				Vdc
Continuous Drain Current $T_C=25^\circ C$	$I_D$	10	10	8.0	8.0	Adc
Continuous Drain Current $T_C=100^\circ C$	$I_D$	6.0	6.0	5.0	5.0	Adc
Drain Current—Pulsed (3)	$I_{DM}$	40	40	32	32	Adc
Gate Current—Pulsed	$I_{GM}$	$\pm 1.5$				Adc
Total Power Dissipation @ $T_C=25^\circ C$	$P_D$	125				Watts
Derate above $25^\circ C$		1.0				W/ $^\circ C$
Operating and Storage Junction Temperature Range	$T_J, T_{stg}$	-55 to 150				$^\circ C$
Maximum Lead Temp. for Soldering Purposes, 1/8" from case for 5 seconds	$T_L$	300				$^\circ C$

Notes: (1)  $T_J=25^\circ C$  to  $150^\circ C$

(2) Pulse test: Pulse width  $\leq 300\mu s$ , Duty Cycle  $\leq 2\%$

(3) Repetitive rating: Pulse width limited by max. junction temperature

**IRF340/341/342/343****N-CHANNEL  
POWER MOSFETS****ELECTRICAL CHARACTERISTICS** ( $T_C=25^\circ\text{C}$  unless otherwise specified)

Characteristic	Symbol	Type	Min	Typ	Max	Units	Test Conditions
Drain-Source Breakdown Voltage	$BV_{DSS}$	IRF340	400	—	—	V	$V_{GS}=0V$ $I_D=250\mu A$
		IRF342					
		IRF341 IRF343	350	—	—	V	
Gate Threshold Voltage	$V_{GS(th)}$	ALL	2.0	—	4.0	V	$V_{DS}=V_{GS}$ , $I_D=250\mu A$
Gate-Source Leakage Forward	$I_{GSS}$	ALL	—	—	100	nA	$V_{GS}=20V$
Gate-Source Leakage Reverse	$I_{GSS}$	ALL	—	—	-100	nA	$V_{GS}=-20V$
Zero Gate Voltage Drain Current	$I_{DSS}$	ALL	—	—	250	$\mu A$	$V_{DS}=\text{Max. Rating}$ , $V_{GS}=0V$
			—	—	1000	$\mu A$	$V_{DS}=\text{Max. Rating}\times 0.8$ , $V_{GS}=0V$ , $T_C=125^\circ\text{C}$
On-State Drain-Source Current (2)	$I_{D(on)}$	IRF340 IRF341	10	—	—	A	$V_{DS}>I_{D(on)}\times R_{DS(on) \text{ max.}}$ , $V_{GS}=10V$
		IRF342 IRF343					
Static Drain-Source On-State Resistance (2)	$R_{DS(on)}$	IRF340 IRF341	—	0.30	0.55	$\Omega$	$V_{GS}=10V$ , $I_D=5.0A$
		IRF342 IRF343					
Forward Transconductance (2)	$g_{fs}$	ALL	4.0	7.0	—	$\Omega$	$V_{DS}>I_{D(on)}\times R_{DS(on) \text{ max.}}$ , $I_D=5.0A$
Input Capacitance	$C_{iss}$	ALL	—	1300	1600	pF	$V_{GS}=0V$ , $V_{DS}=25V$ , $f=1.0\text{MHz}$
Output Capacitance	$C_{oss}$	ALL	—	250	450	pF	
Reverse Transfer Capacitance	$C_{rss}$	ALL	—	50	150	pF	
Turn-On Delay Time	$t_{d(on)}$	ALL	—	—	35	ns	$V_{DD}=0.5BV_{DSS}$ , $I_D=5.0A$ , $Z_o=4.7\Omega$ (MOSFET switching times are essentially independent of operating temperature.)
Rise Time	$t_r$	ALL	—	—	15	ns	
Turn-Off Delay Time	$t_{d(off)}$	ALL	—	—	90	ns	
Fall Time	$t_f$	ALL	—	—	35	ns	
Total Gate Charge (Gate-Source Plus Gate-Drain)	$Q_g$	ALL	—	41	60	nC	$V_{GS}=10V$ , $I_D=12A$ , $V_{DS}=0.8 \text{ Max. Rating}$ (Gate charge is essentially independent of operating temperature.)
Gate-Source Charge	$Q_{gs}$	ALL	—	6.0	—	nC	
Gate-Drain ("Miller") Charge	$Q_{gd}$	ALL	—	35	—	nC	

**THERMAL RESISTANCE**

Junction-to-Case	$R_{thJC}$	ALL	—	—	1.0	K/W	
Case-to-Sink	$R_{thCS}$	ALL	—	0.1	—	K/W	Mounting surface flat, smooth, and greased
Junction-to-Ambient	$R_{thJA}$	ALL	—	—	30	K/W	Free Air Operation

- Notes: (1)  $T_J=25^\circ\text{C}$  to  $150^\circ\text{C}$   
(2) Pulse test: Pulse width  $\leq 300\mu\text{s}$ , Duty Cycle  $\leq 2\%$   
(3) Repetitive rating: Pulse width limited by max. junction temperature

**IRF340/341/342/343**

**N-CHANNEL  
POWER MOSFETS**

**SOURCE-DRAIN DIODE RATINGS AND CHARACTERISTICS**

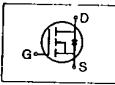
Characteristic	Symbol	Type	Min	Typ	Max	Units	Test Conditions
Continuous Source Current (Body Diode)	I <sub>S</sub>	IRF340 IRF341	—	—	10	A	Modified MOSFET symbol showing the integral reverse P-N junction rectifier 
		IRF342 IRF343	—	—	8.0	A	
Pulse Source Current (Body Diode) (3)	I <sub>SM</sub>	IRF340 IRF341	—	—	40	A	
		IRF342 IRF343	—	—	32	A	
		IRF340 IRF341	—	—	2.0	V	T <sub>C</sub> =25°C, I <sub>S</sub> =10A, V <sub>GS</sub> =0V
Diode Forward Voltage (2)	V <sub>SD</sub>	IRF342 IRF343	—	—	1.9	V	T <sub>C</sub> =25°C, I <sub>S</sub> =8.0A, V <sub>GS</sub> =0V
		IRF340 IRF341	—	—	1.9	V	T <sub>C</sub> =25°C, I <sub>S</sub> =8.0A, V <sub>GS</sub> =0V
Reverse Recovery Time	t <sub>rr</sub>	ALL	—	800	—	ns	T <sub>J</sub> =150°C, I <sub>F</sub> =10A, dI <sub>F</sub> /dt=100A/μs

Notes: (1) T<sub>J</sub>=25°C to 150°C (2) Pulse test: Pulse width<300μs, Duty Cycle<2%  
(3) Repetitive rating: Pulse width limited by max. junction temperature

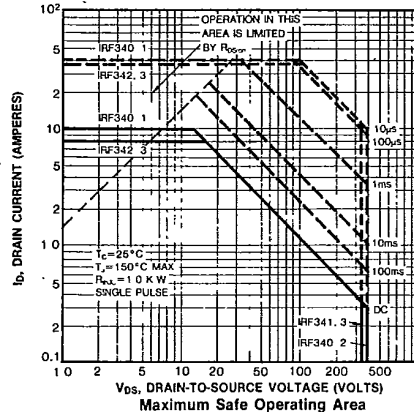
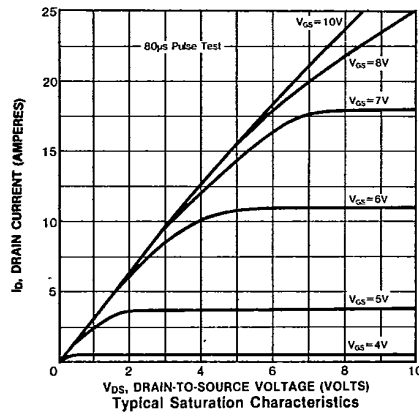
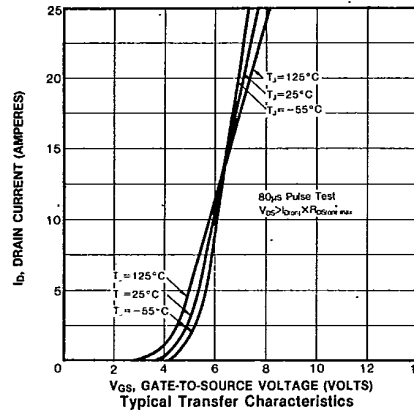
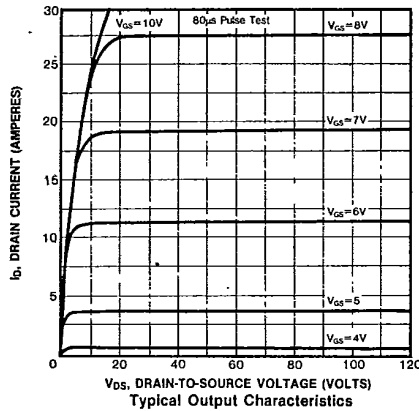

IRF340/341/342/343

N-CHANNEL  
POWER MOSFETS

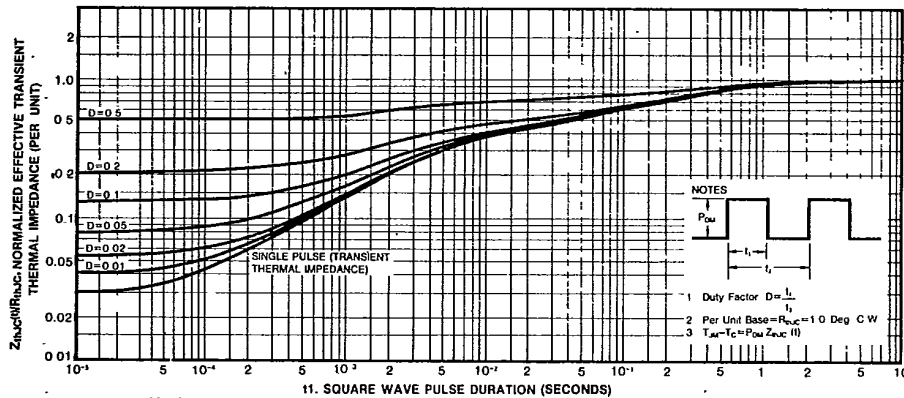

11. SQUARE WAVE PULSE DURATION (SECONDS)  
Maximum Effective Transient Thermal Impedance Junction-to-Case Vs. Pulse Duration

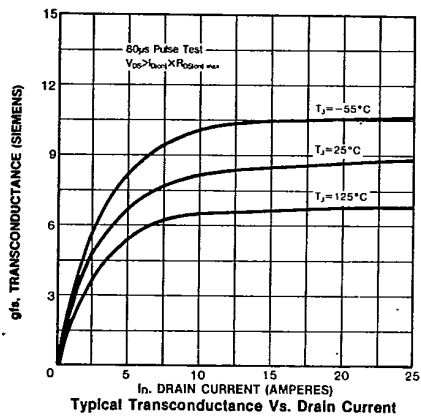

Typical Transconductance Vs. Drain Current

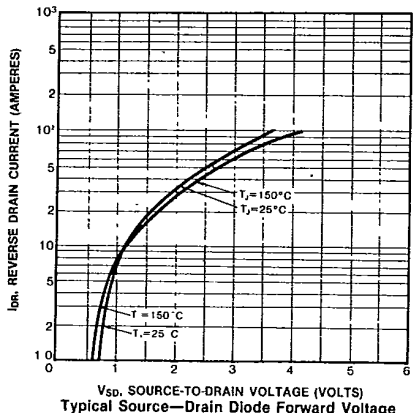

Typical Source-Drain Diode Forward Voltage

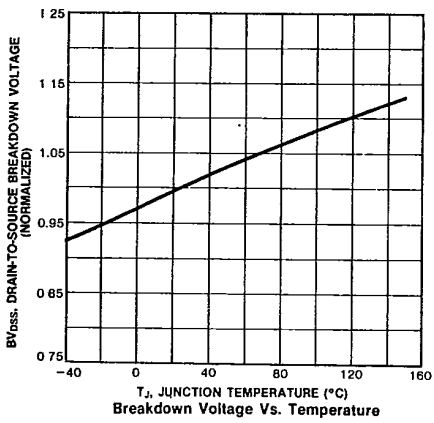

Breakdown Voltage Vs. Temperature

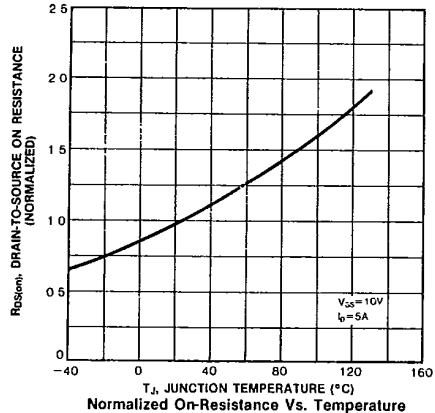

Normalized On-Resistance Vs. Temperature

IRF340/341/342/343

N-CHANNEL POWER MOSFETS

