

**Applications**

- High Frequency DC-DC Isolated Converters with Synchronous Rectification for Telecom and Industrial use
- High Frequency Buck Converters for Computer Processor Power
- Lead-Free

HEXFET® Power MOSFET

<b>V<sub>DSS</sub></b>	<b>R<sub>DS(on)</sub> max</b>	<b>I<sub>D</sub></b>
<b>30V</b>	<b>12.5mΩ</b>	<b>62A</b>

**Benefits**

- Ultra-Low Gate Impedance
- Very Low R<sub>DS(on)</sub>
- Fully Characterized Avalanche Voltage and Current

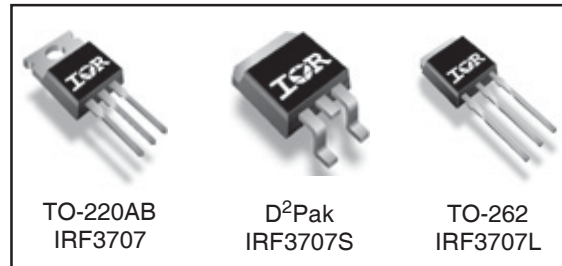

**Absolute Maximum Ratings**

Symbol	Parameter	Max.	Units
V <sub>DS</sub>	Drain-Source Voltage	30	V
V <sub>GS</sub>	Gate-to-Source Voltage	± 20	V
I <sub>D</sub> @ T <sub>C</sub> = 25°C	Continuous Drain Current, V <sub>GS</sub> @ 10V	62	A
I <sub>D</sub> @ T <sub>C</sub> = 70°C	Continuous Drain Current, V <sub>GS</sub> @ 10V	52	
I <sub>DM</sub>	Pulsed Drain Current <sup>①</sup>	248	
P <sub>D</sub> @ T <sub>C</sub> = 25°C	Maximum Power Dissipation <sup>③</sup>	87	W
P <sub>D</sub> @ T <sub>C</sub> = 70°C	Maximum Power Dissipation <sup>③</sup>	61	W
	Linear Derating Factor	0.59	mW/°C
T <sub>J</sub> , T <sub>STG</sub>	Junction and Storage Temperature Range	-55 to + 175	°C

**Thermal Resistance**

	Parameter	Typ.	Max.	Units
R <sub>θJC</sub>	Junction-to-Case	—	1.73	°C/W
R <sub>θCS</sub>	Case-to-Sink, Flat, Greased Surface <sup>④</sup>	0.50	—	
R <sub>θJA</sub>	Junction-to-Ambient <sup>④</sup>	—	62	
R <sub>θJA</sub>	Junction-to-Ambient (PCB mount)*	—	40	

\* When mounted on 1" square PCB (FR-4 or G-10 Material) .  
For recommended footprint and soldering techniques refer to application note #AN-994

Notes ① through ④ are on page 10

# IRF3707S/LPbF

International  
**IR** Rectifier

## Static @ T<sub>J</sub> = 25°C (unless otherwise specified)

	Parameter	Min.	Typ.	Max.	Units	Conditions
V <sub>(BR)DSS</sub>	Drain-to-Source Breakdown Voltage	30	—	—	V	V <sub>GS</sub> = 0V, I <sub>D</sub> = 250μA
ΔV <sub>(BR)DSS</sub> /ΔT <sub>J</sub>	Breakdown Voltage Temp. Coefficient	—	0.027	—	V/°C	Reference to 25°C, I <sub>D</sub> = 1mA
R <sub>DS(on)</sub>	Static Drain-to-Source On-Resistance	—	9.0	12.5	mΩ	V <sub>GS</sub> = 10V, I <sub>D</sub> = 15A ③
		—	12.6	17		V <sub>GS</sub> = 4.5V, I <sub>D</sub> = 12A ③
V <sub>GS(th)</sub>	Gate Threshold Voltage	1.0	—	3.0	V	V <sub>DS</sub> = V <sub>GS</sub> , I <sub>D</sub> = 250μA
I <sub>DSS</sub>	Drain-to-Source Leakage Current	—	—	20	μA	V <sub>DS</sub> = 24V, V <sub>GS</sub> = 0V
		—	—	100		V <sub>DS</sub> = 24V, V <sub>GS</sub> = 0V, T <sub>J</sub> = 125°C
I <sub>GSS</sub>	Gate-to-Source Forward Leakage	—	—	200	nA	V <sub>GS</sub> = 16V
	Gate-to-Source Reverse Leakage	—	—	-200		V <sub>GS</sub> = -16V

## Dynamic @ T<sub>J</sub> = 25°C (unless otherwise specified)

Symbol	Parameter	Min.	Typ.	Max.	Units	Conditions
g <sub>fs</sub>	Forward Transconductance	37	—	—	S	V <sub>DS</sub> = 15V, I <sub>D</sub> = 49.6A
Q <sub>g</sub>	Total Gate Charge	—	19	—	nC	I <sub>D</sub> = 24.8A
Q <sub>gs</sub>	Gate-to-Source Charge	—	8.2	—		V <sub>DS</sub> = 15V
Q <sub>gd</sub>	Gate-to-Drain ("Miller") Charge	—	6.3	—		V <sub>GS</sub> = 4.5V ③
Q <sub>oss</sub>	Output Gate Charge	—	18	27		V <sub>GS</sub> = 0V, V <sub>DS</sub> = 15V
t <sub>d(on)</sub>	Turn-On Delay Time	—	8.5	—	ns	V <sub>DD</sub> = 15V
t <sub>r</sub>	Rise Time	—	78	—		I <sub>D</sub> = 24.8A
t <sub>d(off)</sub>	Turn-Off Delay Time	—	11.8	—		R <sub>G</sub> = 1.8Ω
t <sub>f</sub>	Fall Time	—	3.3	—		V <sub>GS</sub> = 4.5V ③
C <sub>iss</sub>	Input Capacitance	—	1990	—	pF	V <sub>GS</sub> = 0V
C <sub>oss</sub>	Output Capacitance	—	707	—		V <sub>DS</sub> = 15V
C <sub>rss</sub>	Reverse Transfer Capacitance	—	50	—		f = 1.0MHz

## Avalanche Characteristics

Symbol	Parameter	Typ.	Max.	Units
E <sub>AS</sub>	Single Pulse Avalanche Energy②	—	213	mJ
I <sub>AR</sub>	Avalanche Current①	—	62	A

## Diode Characteristics

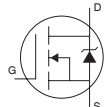
Symbol	Parameter	Min.	Typ.	Max.	Units	Conditions
I <sub>S</sub>	Continuous Source Current (Body Diode)	—	—	62	A	MOSFET symbol showing the integral reverse p-n junction diode. 
I <sub>SM</sub>	Pulsed Source Current (Body Diode) ①	—	—	248		
V <sub>SD</sub>	Diode Forward Voltage	—	0.88	1.3	V	T <sub>J</sub> = 25°C, I <sub>S</sub> = 31A, V <sub>GS</sub> = 0V ③
		—	0.8	—		T <sub>J</sub> = 125°C, I <sub>S</sub> = 31A, V <sub>GS</sub> = 0V ③
t <sub>rr</sub>	Reverse Recovery Time	—	39	59	ns	T <sub>J</sub> = 25°C, I <sub>F</sub> = 31A, V <sub>R</sub> = 20V
Q <sub>rr</sub>	Reverse Recovery Charge	—	49	74	nC	di/dt = 100A/μs ③
t <sub>rr</sub>	Reverse Recovery Time	—	42	63	ns	T <sub>J</sub> = 125°C, I <sub>F</sub> = 31A, V <sub>R</sub> = 20V
Q <sub>rr</sub>	Reverse Recovery Charge	—	62	93	nC	di/dt = 100A/μs ③

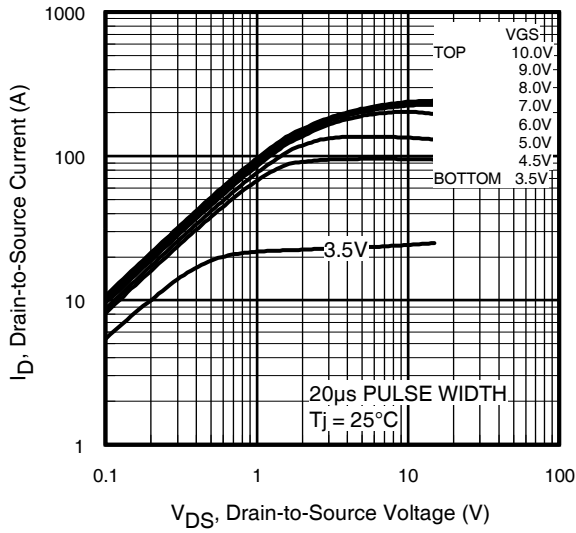

**Fig 1.** Typical Output Characteristics

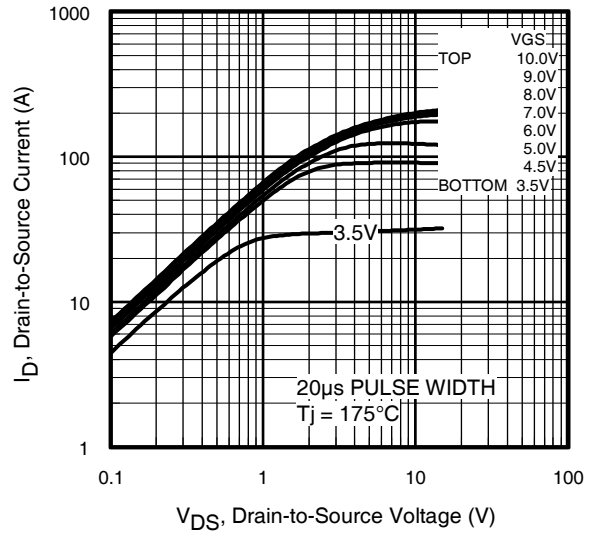

**Fig 2.** Typical Output Characteristics

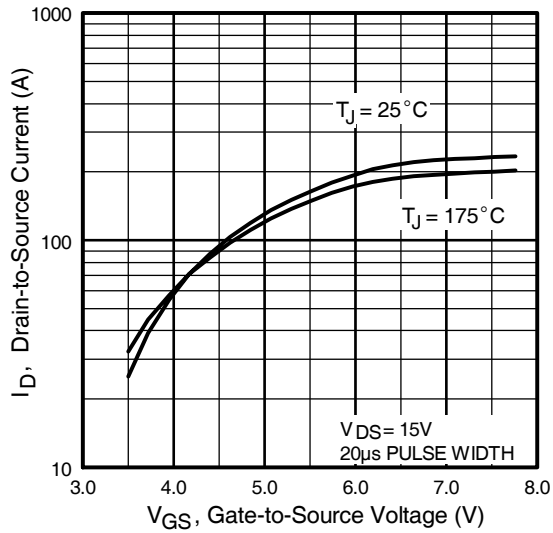

**Fig 3.** Typical Transfer Characteristics

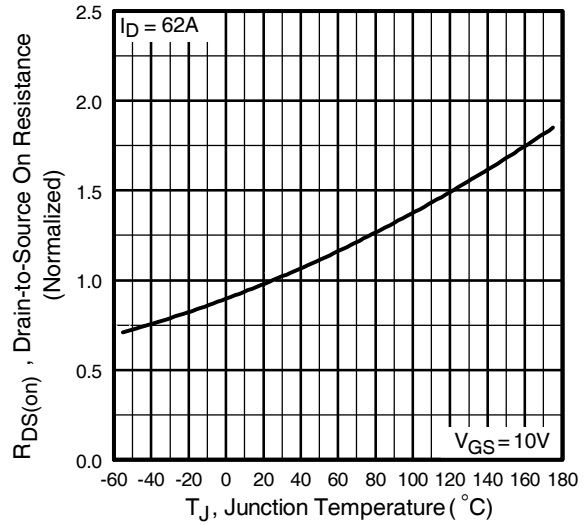

**Fig 4.** Normalized On-Resistance Vs. Temperature

# IRF3707S/LPbF

International  
**IR** Rectifier

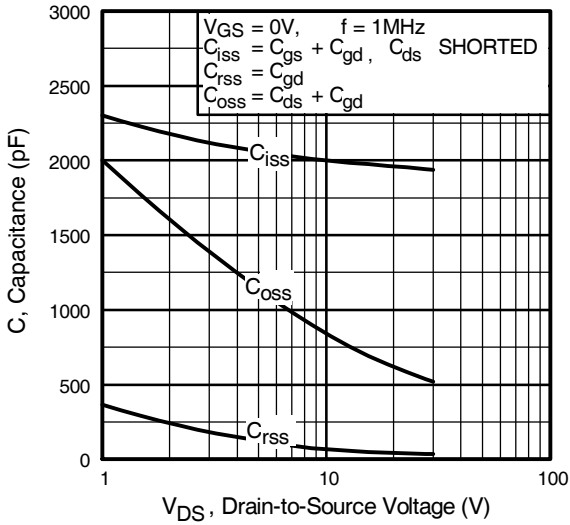

**Fig 5.** Typical Capacitance Vs. Drain-to-Source Voltage

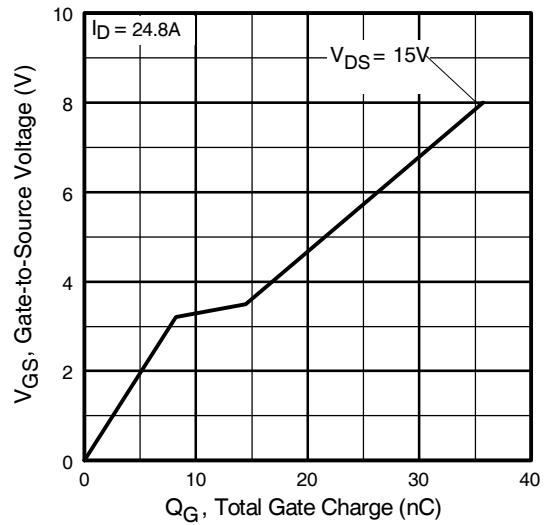

**Fig 6.** Typical Gate Charge Vs. Gate-to-Source Voltage

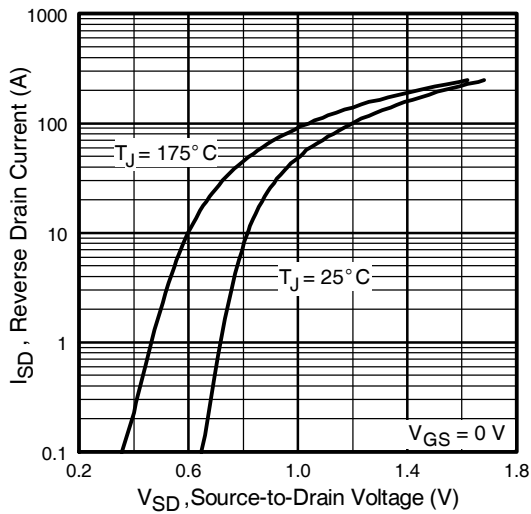

**Fig 7.** Typical Source-Drain Diode Forward Voltage

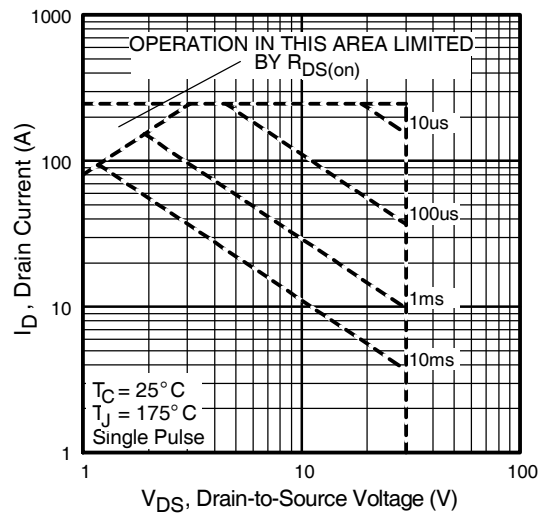

**Fig 8.** Maximum Safe Operating Area

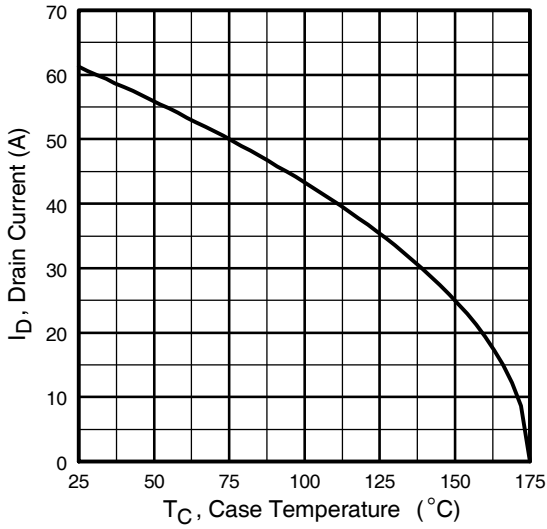

**Fig 9.** Maximum Drain Current Vs. Case Temperature

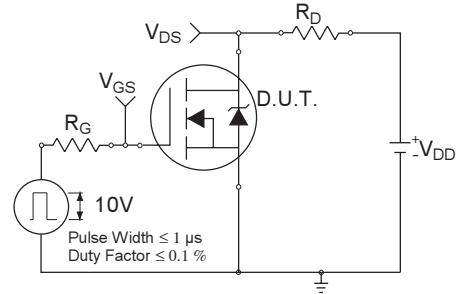

**Fig 10a.** Switching Time Test Circuit

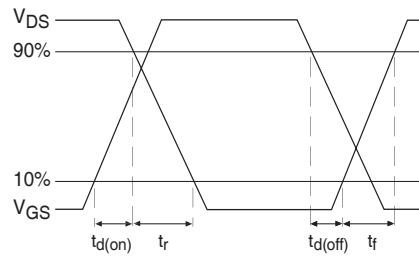

**Fig 10b.** Switching Time Waveforms

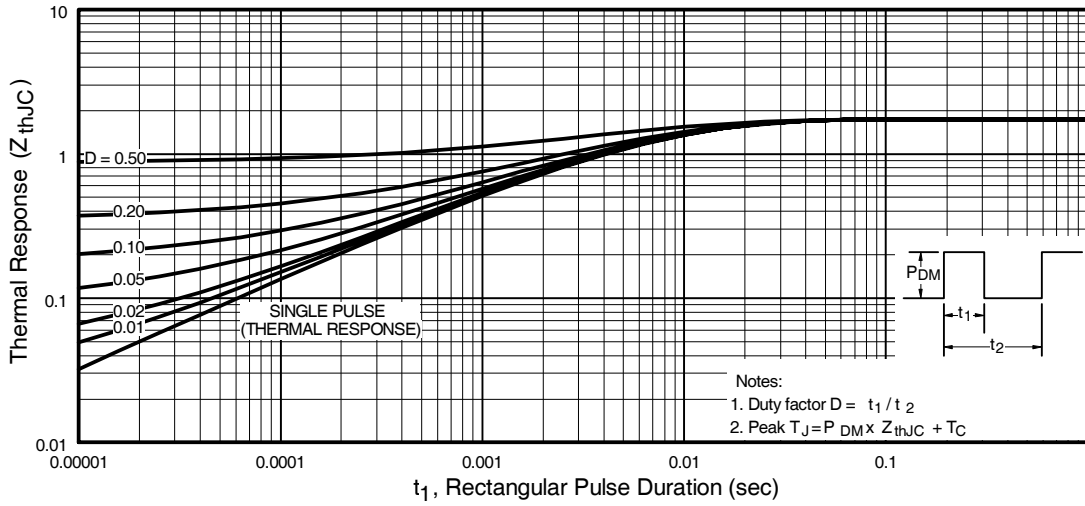

**Fig 11.** Maximum Effective Transient Thermal Impedance, Junction-to-Ambient

# IRF3707S/LPbF

International  
**IR** Rectifier

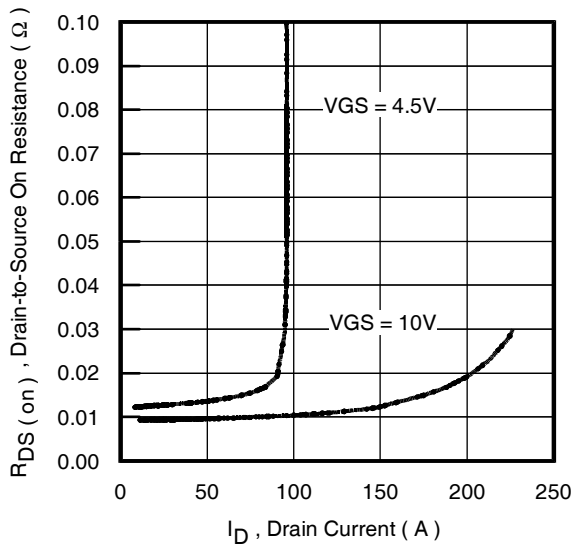

**Fig 12.** On-Resistance Vs. Drain Current

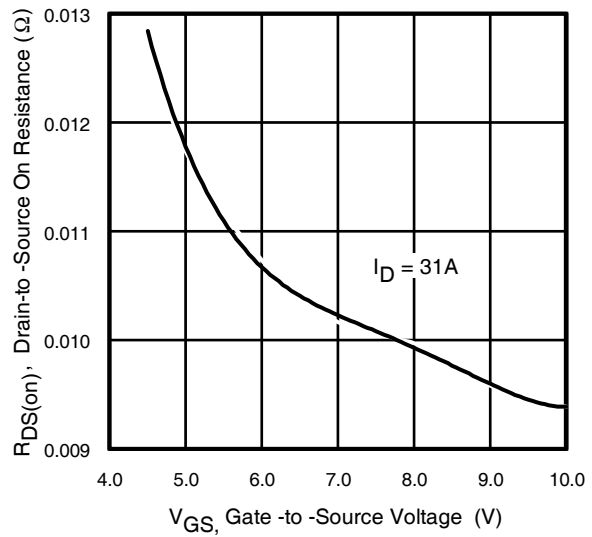

**Fig 13.** On-Resistance Vs. Gate Voltage

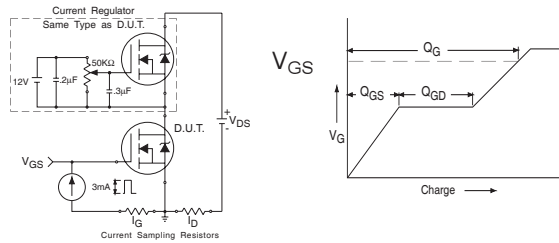

**Fig 14a&b.** Basic Gate Charge Test circuit and Waveforms

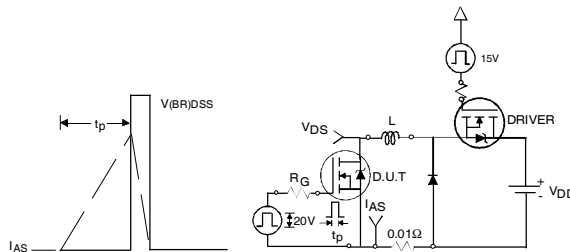

**Fig 15a&b.** Unclamped Inductive Test circuit and Waveforms

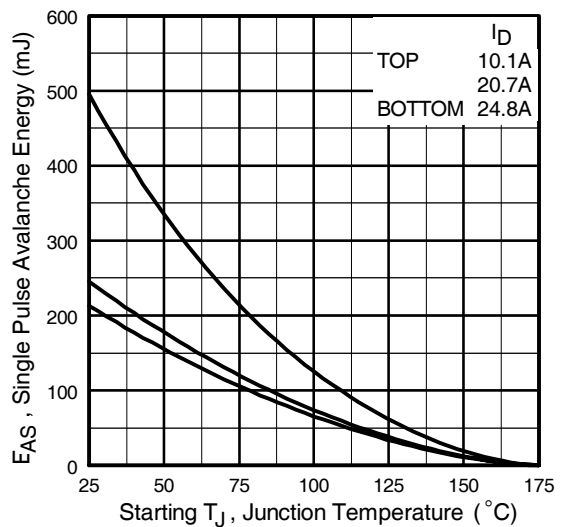

**Fig 15c.** Maximum Avalanche Energy Vs. Drain Current

## TO-220AB Package Outline

Dimensions are shown in millimeters (inches)

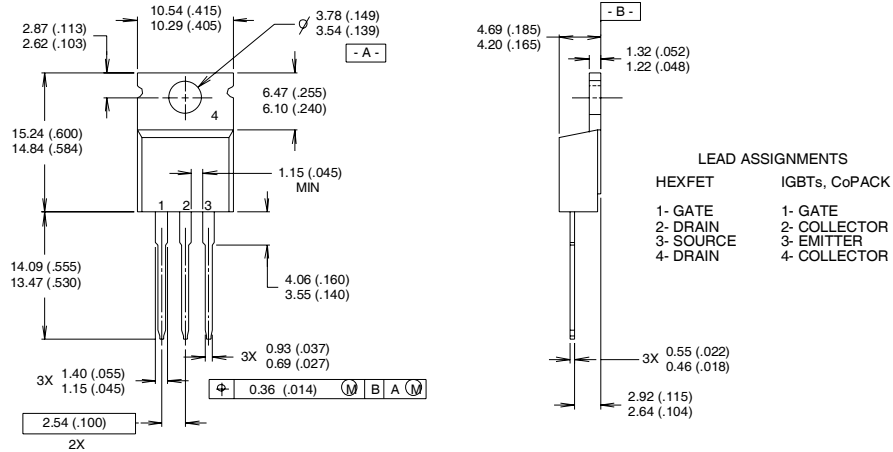

- NOTES:
- 1 DIMENSIONING & TOLERANCING PER ANSI Y14.5M, 1982.
  - 2 CONTROLLING DIMENSION : INCH
  - 3 OUTLINE CONFORMS TO JEDEC OUTLINE TO-220AB.
  - 4 HEATSINK & LEAD MEASUREMENTS DO NOT INCLUDE BURRS.

## TO-220AB Part Marking Information

EXAMPLE: THIS IS AN IRF1010  
 LOT CODE 1789  
 ASSEMBLED ON WW 19, 1997  
 IN THE ASSEMBLY LINE "C"

**Note:** "P" in assembly line position indicates "Lead-Free"

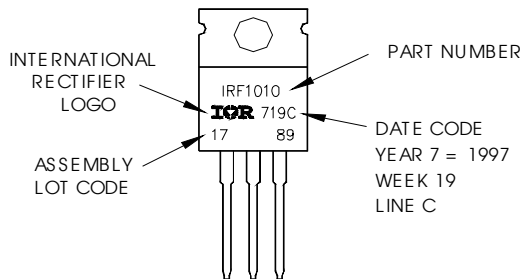

# IRF3707S/LPbF

International  
**IR** Rectifier

## D<sup>2</sup>Pak Package Outline

Dimensions are shown in millimeters (inches)

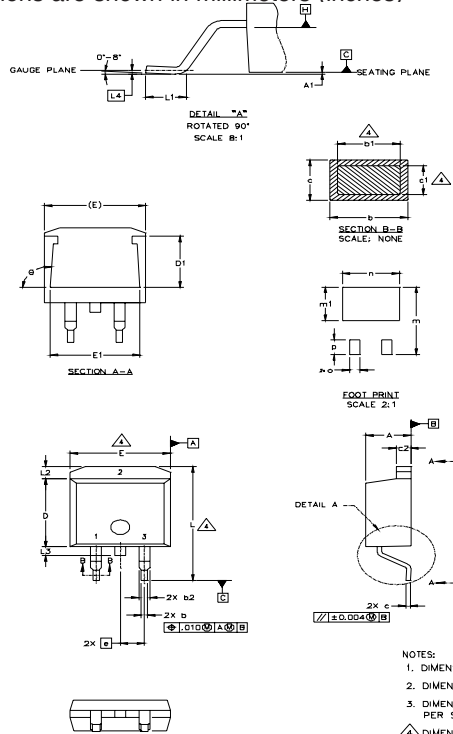

SYMBOL	DIMENSIONS				NOTES
	MILLIMETERS		INCHES		
	MIN.	MAX.	MIN.	MAX.	
A	4.06	4.83	.160	.190	4
A1		0.127	.005		
b	0.51	0.99	.020	.039	
b1	0.51	0.89	.020	.035	
b2	1.14	1.40	.045	.055	4
c	0.43	0.63	.017	.025	
c1	0.38	0.74	.015	.029	3
c2	1.14	1.40	.045	.055	
D	8.51	9.65	.335	.380	3
D1	5.33		.210		
E	9.65	10.67	.380	.420	
E1	6.22		.245		
e	2.54 BSC		.100 BSC		
L	14.61	15.88	.575	.625	
L1	1.78	2.79	.070	.110	
L2		1.65		.065	
L3	1.27	1.78	.050	.070	
L4	0.25 BSC		.010 BSC		
m	17.78		.700		
m1	8.89		.350		
n	11.43		.450		
o	2.08		.082		
p	3.81		.150		
theta	90°	93°	90°	93°	

### LEAD ASSIGNMENTS

HEXFET	IGBTs, CoPACK	DIODES
1.- GATE	1.- GATE	1.- ANODE *
2.- DRAIN	2.- COLLECTOR	2.- CATHODE
3.- SOURCE	3.- EMITTER	3.- ANODE

\* PART DEPENDENT.

### NOTES:

1. DIMENSIONING AND TOLERANCING PER ASME Y14.5M-1994
2. DIMENSIONS ARE SHOWN IN MILLIMETERS [INCHES]
3. DIMENSION D & E DO NOT INCLUDE MOLD FLASH. MOLD FLASH SHALL NOT EXCEED 0.127 (.005") PER SIDE. THESE DIMENSIONS ARE MEASURED AT THE OUTMOST EXTREMES OF THE PLASTIC BODY.
4. DIMENSION b1 AND c1 APPLY TO BASE METAL ONLY.
5. CONTROLLING DIMENSION: INCH.

## D<sup>2</sup>Pak Part Marking Information (Lead-Free)

EXAMPLE: THIS IS AN IRF530S WITH  
LOT CODE 8024  
ASSEMBLED ON WW 02, 2000  
IN THE ASSEMBLY LINE "L"

Note: "P" in assembly line  
position indicates "Lead-Free"

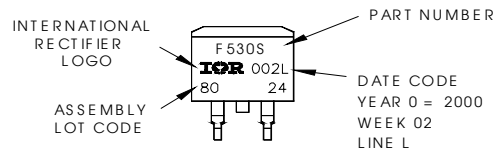

**OR**

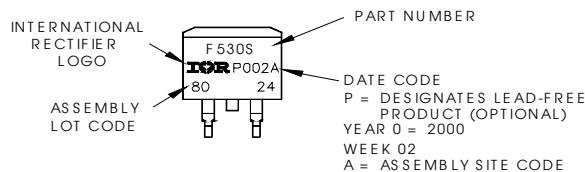



## TO-262 Package Outline

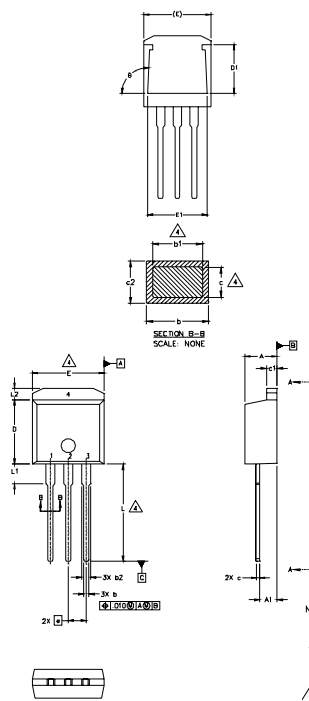

SYMBOL	DIMENSIONS				NOTES
	MILLIMETERS		INCHES		
	MIN.	MAX.	MIN.	MAX.	
A	4.06	4.83	.160	.190	4
A1	2.03	2.92	.080	.115	
b	0.51	0.99	.020	.039	
b1	0.51	0.89	.020	.035	
b2	1.14	1.40	.045	.055	4
c	0.38	0.63	.015	.025	
c1	1.14	1.40	.045	.055	
c2	0.43	.063	.017	.029	3
D	8.51	9.65	.335	.380	
D1	5.33		.210		3
E	9.65	10.67	.380	.420	
E1	6.22		.245		
e	2.54 BSC		.100 BSC		
L	13.46	14.09	.530	.555	
L1	3.56	3.71	.140	.146	
L2		1.65		.065	

### LEAD ASSIGNMENTS

HEXFET		IGBT
1.- GATE	2.- COLLECTOR	3.- EMITTER
2.- DRAIN	3.- SOURCE	4.- DRAIN

- NOTES:
1. DIMENSIONING AND TOLERANCING PER ASME Y14.5M-1994
  2. DIMENSIONS ARE SHOWN IN MILLIMETERS [INCHES].
  3. DIMENSION D & E DO NOT INCLUDE MOLD FLASH. MOLD FLASH SHALL NOT EXCEED 0.127 [0.005"] PER SIDE. THESE DIMENSIONS ARE MEASURED AT THE OUTMOST EXTREMES OF THE PLASTIC BODY.
  4. DIMENSION b1 AND c1 APPLY TO BASE METAL ONLY.
  5. CONTROLLING DIMENSION: INCH.

## TO-262 Part Marking Information

EXAMPLE: THIS IS AN IRL3103L  
 LOT CODE 1789  
 ASSEMBLED ON WW 19, 1997  
 IN THE ASSEMBLY LINE "C"  
 Note: "P" in assembly line position indicates "Lead-Free"

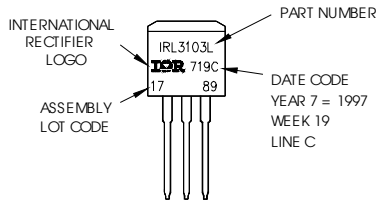

OR

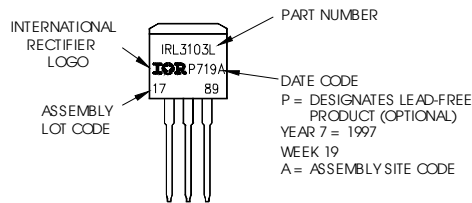

# IRF3707S/LPbF

International  
**IR** Rectifier

## D<sup>2</sup>Pak Tape & Reel Information

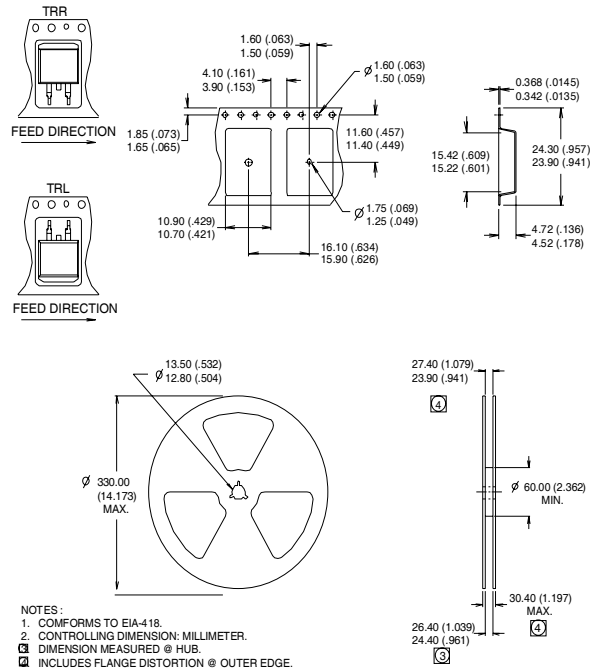

### Notes:

- ① Repetitive rating; pulse width limited by max. junction temperature.
- ② Starting  $T_J = 25^\circ\text{C}$ ,  $L = 0.7 \text{ mH}$   
 $R_G = 25\Omega$ ,  $I_{AS} = 24.8 \text{ A}$ .
- ③ Pulse width  $\leq 300\mu\text{s}$ ; duty cycle  $\leq 2\%$ .
- ④ This is only applied to TO-220AB package

Data and specifications subject to change without notice.

International  
**IR** Rectifier

**IR WORLD HEADQUARTERS:** 233 Kansas St., El Segundo, California 90245, USA Tel: (310) 252-7105  
TAC Fax: (310) 252-7903

Visit us at [www.irf.com](http://www.irf.com) for sales contact information.07/04

[www.irf.com](http://www.irf.com)