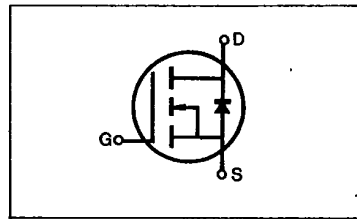
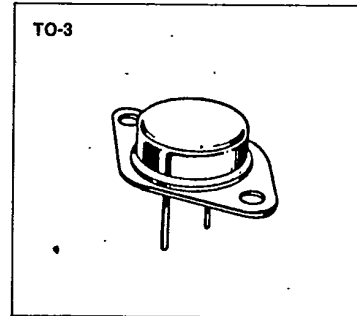

IRF440/441/442/443**N-CHANNEL
POWER MOSFETS****FEATURES**

- Low $R_{DS(on)}$ at high voltage
- Improved inductive ruggedness
- Excellent high voltage stability
- Fast switching times
- Rugged polysilicon gate cell structure
- Low input capacitance
- Extended safe operating area
- Improved high temperature reliability
- TO-3 package (High voltage)

**PRODUCT SUMMARY**

Part Number	V_{DS}	$R_{DS(on)}$	I_D
IRF440	500V	0.85 Ω	8.0A
IRF441	450V	0.85 Ω	8.0A
IRF442	500V	1.10 Ω	7.0A
IRF443	450V	1.10 Ω	7.0A

MAXIMUM RATINGS

Characteristic	Symbol	IRF440	IRF441	IRF442	IRF443	Unit
Drain-Source Voltage (1)	V_{DSS}	500	450	500	450	Vdc
Drain-Gate Voltage ($R_{GS}=1.0M\Omega$) (1)	V_{DGR}	500	450	500	450	Vdc
Gate-Source Voltage	V_{GS}	± 20				Vdc
Continuous Drain Current $T_C=25^\circ C$	I_D	8.0	8.0	7.0	7.0	Adc
Continuous Drain Current $T_C=100^\circ C$	I_D	5.0	5.0	4.0	4.0	Adc
Drain Current—Pulsed (3)	I_{DM}	32	32	28	28	Adc
Gate Current—Pulsed	I_{GM}	± 1.5				Adc
Total Power Dissipation @ $T_C=25^\circ C$ Derate above $25^\circ C$	P_D	125 1.0				Watts W/ $^\circ C$
Operating and Storage Junction Temperature Range	T_J, T_{stg}	-55 to 150				$^\circ C$
Maximum Lead Temp. for Soldering Purposes, 1/8" from case for 5 seconds	T_L	300				$^\circ C$

Notes: (1) $T_J=25^\circ C$ to $150^\circ C$

(2) Pulse test: Pulse width $\leq 300\mu s$, Duty Cycle $\leq 2\%$

(3) Repetitive rating: Pulse width limited by max. junction temperature

IRF440/441/442/443**N-CHANNEL
POWER MOSFETS****ELECTRICAL CHARACTERISTICS** ($T_C=25^\circ\text{C}$ unless otherwise specified)

Characteristic	Symbol	Type	Min	Typ	Max	Units	Test Conditions
Drain-Source Breakdown Voltage	BV_{DSS}	IRF440 IRF442	500	—	—	V	$V_{GS}=0V$
		IRF441 IRF443	450	—	—	V	$I_D=250\mu A$
Gate Threshold Voltage	$V_{GS(th)}$	ALL	2.0	—	4.0	V	$V_{DS}=V_{GS}$, $I_D=250\mu A$
Gate-Source Leakage Forward	I_{GSS}	ALL	—	—	100	nA	$V_{GS}=20V$
Gate-Source Leakage Reverse	I_{GSS}	ALL	—	—	-100	nA	$V_{GS}=-20V$
Zero Gate Voltage Drain Current	I_{DSS}	ALL	—	—	250	μA	$V_{DS}=\text{Max. Rating}$, $V_{GS}=0V$
		ALL	—	—	1000	μA	$V_{DS}=\text{Max. Rating} \times 0.8$, $V_{GS}=0V$, $T_C=125^\circ\text{C}$
On-State Drain-Source Current (2)	$I_{D(on)}$	IRF440 IRF441	8.0	—	—	A	$V_{DS} > I_{D(on)} \times R_{DS(on) \text{ max.}}$, $V_{GS}=10V$
		IRF442 IRF443	7.0	—	—	A	
Static Drain-Source On-State Resistance (2)	$R_{DS(on)}$	IRF440 IRF441	—	0.6	0.85	Ω	$V_{GS}=10V$, $I_D=4.0A$
		IRF442 IRF443	—	1.0	1.1	Ω	
Forward Transconductance (2)	g_{fs}	ALL	4.0	6.5	—	Ω	$V_{DS} > I_{D(on)} \times R_{DS(on) \text{ max.}}$, $I_D=4.0A$
Input Capacitance	C_{iss}	ALL	—	1200	1600	pF	$V_{GS}=0V$, $V_{DS}=25V$, $f=1.0\text{MHz}$
Output Capacitance	C_{oss}	ALL	—	230	350	pF	
Reverse Transfer Capacitance	C_{rss}	ALL	—	65	150	pF	
Turn-On Delay Time	$t_{d(on)}$	ALL	—	—	35	ns	
Rise Time	t_r	ALL	—	—	15	ns	$V_{DD}=0.5BV_{DSS}$, $I_D=4.0A$, $Z_\theta=4.7\Omega$ (MOSFET switching times are essentially independent of operating temperature.)
Turn-Off Delay Time	$t_{d(off)}$	ALL	—	—	90	ns	
Fall Time	t_f	ALL	—	—	30	ns	
Total Gate Charge (Gate-Source Plus Gate-Drain)	Q_g	ALL	—	34	60	nC	$V_{GS}=10V$, $I_D=10A$, $V_{DS}=0.8 \text{ Max. Rating}$ (Gate charge is essentially independent of operating temperature.)
Gate-Source Charge	Q_{gs}	ALL	—	6.0	—	nC	
Gate-Drain ("Miller") Charge	Q_{gd}	ALL	—	28	—	nC	

THERMAL RESISTANCE

Junction to Case	R_{thJC}	ALL	—	—	1.0	K/W	
Case-to-Sink	R_{thCS}	ALL	—	0.1	—	K/W	Mounting surface flat, smooth, and greased
Junction-to-Ambient	R_{thJA}	ALL	—	—	30	K/W	Free Air Operation

Notes: (1) $T_C=25^\circ\text{C}$ to 150°C (2) Pulse test: Pulse width $\leq 300\mu s$, Duty Cycle $\leq 2\%$

(3) Repetitive rating: Pulse width limited by max. junction temperature



IRF440/441/442/443

**N-CHANNEL
POWER MOSFETS**

SOURCE-DRAIN DIODE RATINGS AND CHARACTERISTICS

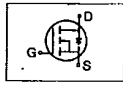
Characteristic	Symbol	Type	Min	Typ	Max	Units	Test Conditions
Continuous Source Current (Body Diode)	I _S	IRF440	—	—	8.0	A	Modified MOSFET symbol showing the integral reverse P-N junction rectifier 
		IRF441	—	—	8.0	A	
		IRF442	—	—	7.0	A	
		IRF443	—	—	7.0	A	
Pulse Source Current (Body Diode) (3)	I _{SM}	IRF440	—	—	32	A	
		IRF441	—	—	32	A	
		IRF442	—	—	28	A	
		IRF443	—	—	28	A	
Diode Forward Voltage (2)	V _{SD}	IRF440	—	—	2.0	V	T _C =25°C, I _S =8.0A, V _{GS} =0V
		IRF441	—	—	2.0	V	T _C =25°C, I _S =8.0A, V _{GS} =0V
		IRF442	—	—	1.9	V	T _C =25°C, I _S =7.0A, V _{GS} =0V
Reverse Recovery Time	t _{rr}	ALL	—	1100	—	ns	T _J =150°C, I _F =8.0A, di _F /dt=100A/μs

Notes: (1) T_J=25°C to 150°C (2) Pulse test: Pulse width≤300μs, Duty Cycle≤2%
(3) Repetitive rating: Pulse width limited by max. junction temperature

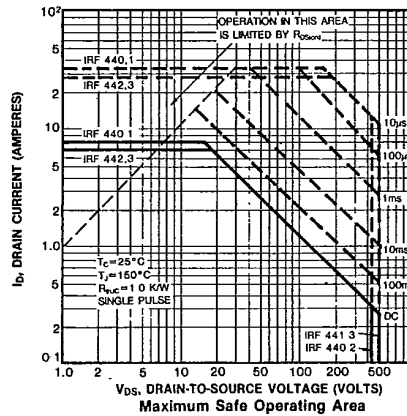
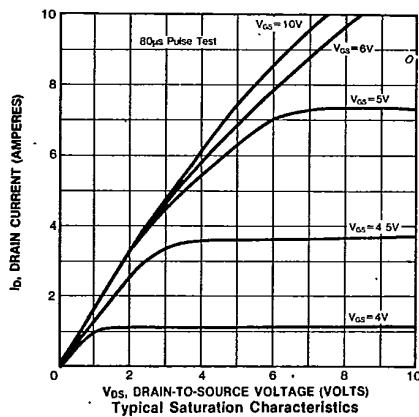
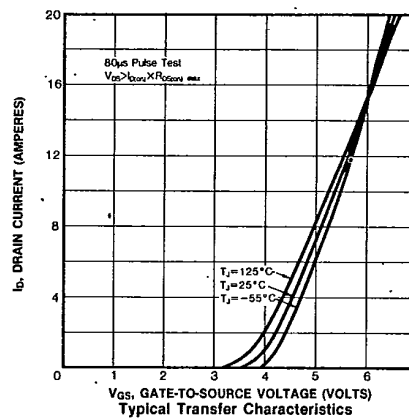
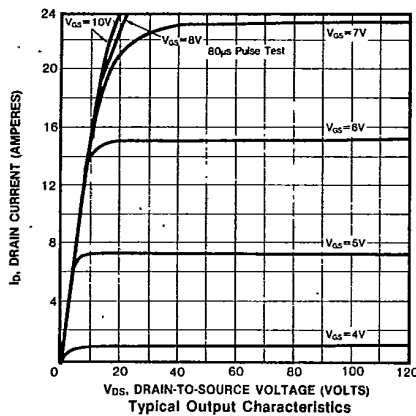

IRF440/441/442/443

N-CHANNEL
POWER MOSFETS

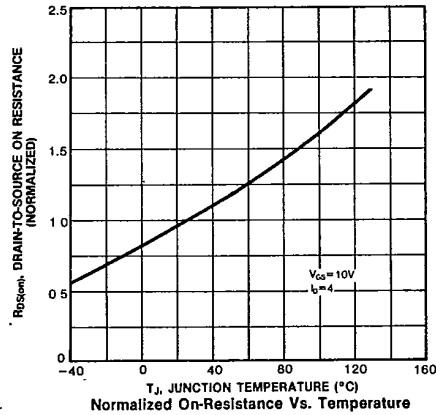
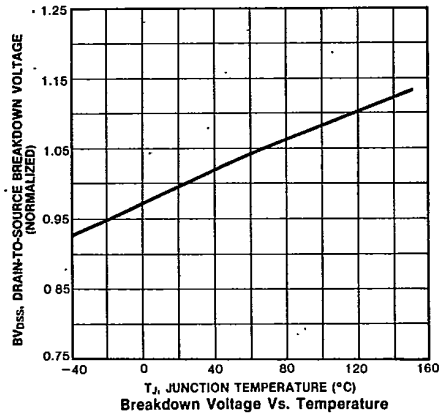
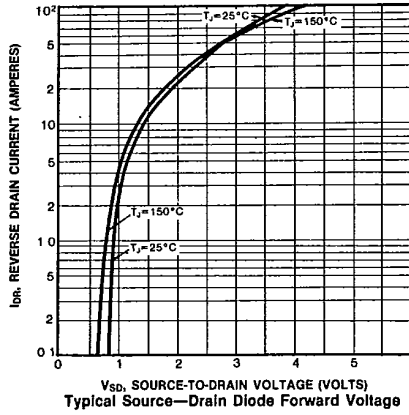
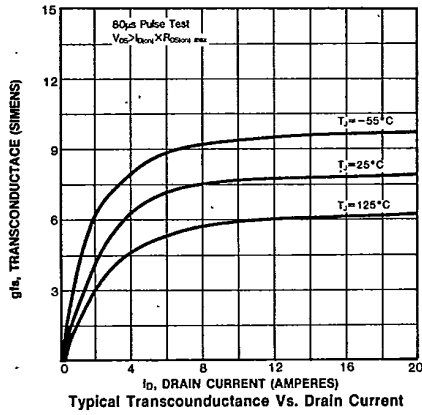
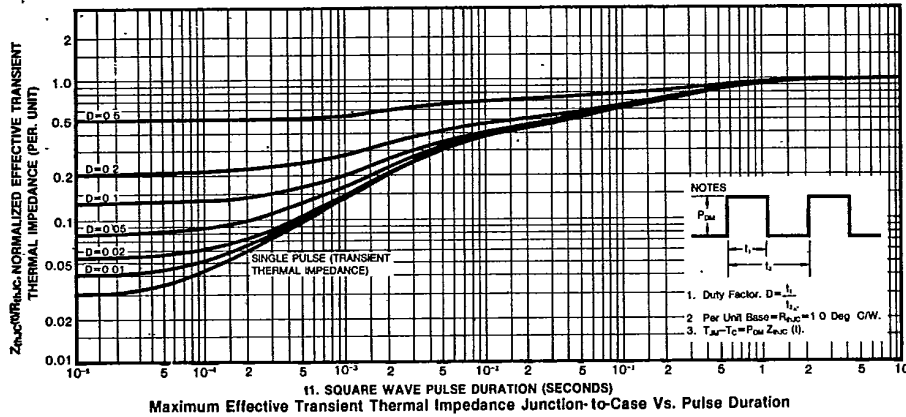

IRF440/441/442/443

N-CHANNEL POWER MOSFETS

