

FAIRCHILD

A Schlumberger Company

IRF120-123/IRF520-523 T-39-11

MTP10N08/10N10

**N-Channel Power MOSFETs,
11 A, 60-100 V**

Power And Discrete Division

Description

These devices are n-channel, enhancement mode, power MOSFETs designed especially for high speed applications, such as switching power supplies, converters, AC and DC motor controls, relay and solenoid drivers and other pulse circuits.

- Low $R_{DS(on)}$
- V_{GS} Rated at ± 20 V
- Silicon Gate for Fast Switching Speeds
- I_{DSS} , $V_{DS(on)}$, Specified at Elevated Temperature
- Rugged
- Low Drive Requirements
- Ease of Paralleling

TO-204AA

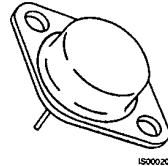

IRF120
IRF121
IRF122
IRF123

TO-220AB

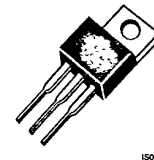

IRF520
IRF521
IRF522
IRF523
MTP10N08
MTP10N10

2

Product Summary

Part Number	V_{DSS}	$R_{DS(on)}$	I_D at $T_C = 25^\circ C$	I_D at $T_C = 100^\circ C$	Case Style
IRF120	100 V	0.30 Ω	8.0 A	5.0 A	TO-204AA
IRF121	60 V	0.30 Ω	8.0 A	5.0 A	
IRF122	100 V	0.40 Ω	7.0 A	4.0 A	
IRF123	60 V	0.40 Ω	7.0 A	4.0 A	
IRF520	100 V	0.30 Ω	8.0 A	5.0 A	TO-220AB
IRF521	60 V	0.30 Ω	8.0 A	5.0 A	
IRF522	100 V	0.40 Ω	7.0 A	4.0 A	
IRF523	60 V	0.40 Ω	7.0 A	4.0 A	
MTP10N08	80 V	0.33 Ω	10 A	6.4 A	
MTP10N10	100 V	0.33 Ω	10 A	6.4 A	

Notes

For information concerning connection diagram and package outline, refer to Section 7.

IRF120-123/IRF520-523
MTP10N08/10N10

.T-39-11

Maximum Ratings

Symbol	Characteristic	Rating IRF120/122 IRF520/522 MTP10N10	Rating MTP10N08	Rating IRF122/123 IRF522/523	Unit
V _{DSS}	Drain to Source Voltage ¹	100	80	60	V
V _{DGR}	Drain to Gate Voltage ¹ R _{GS} = 20 kΩ	100	80	60	V
V _{GS}	Gate to Source Voltage	± 20	± 20	± 20	V
T _J , T _{stg}	Operating Junction and Storage Temperatures	-55 to +150	-55 to +150	-55 to +150	°C
T _L	Maximum Lead Temperature for Soldering Purposes, 1/8" From Case for 5 s	275	275	275	°C

Maximum Thermal Characteristics

		IRF120-123/IRF520-523	MTP10N08/10	
R _{θJC}	Thermal Resistance, Junction to Case	3.12	1.67	°C/W
R _{θJA}	Thermal Resistance, Junction to Ambient	30/80	80	°C/W
P _D	Total Power Dissipation at T _C = 25°C	40	75	W
I _{DM}	Pulsed Drain Current ²	20	32	A

Electrical Characteristics (T_C = 25°C unless otherwise noted)

Symbol	Characteristic	Min	Max	Unit	Test Conditions
Off Characteristics					
V _{(BR)DSS}	Drain Source Breakdown Voltage ¹ IRF120/122/520/522/ MTP10N10 MTP10N08 IRF121/123/521/523	100 80 60		V	V _{GS} = 0 V, I _D = 250 μA
I _{DSS}	Zero Gate Voltage Drain Current		250 1000	μA μA	V _{DS} = Rated V _{DSS} , V _{GS} = 0 V V _{DS} = 0.8 x Rated V _{DSS} , V _{GS} = 0 V, T _C = 125°C
I _{GSS}	Gate-Body Leakage Current IRF120-123 IRF520-523/MTP10N08/10		± 100 ± 500	nA	V _{GS} = ± 20 V, V _{DS} = 0 V

IRF120-123/IRF520-523
MTP10N08/10N10

T-39-11

Electrical Characteristics (Cont.) ($T_C = 25^\circ\text{C}$ unless otherwise noted)

Symbol	Characteristic	Min	Max	Unit	Test Conditions
On Characteristics					
$V_{GS(th)}$	Gate Threshold Voltage			V	$I_D = 250 \mu\text{A}$, $V_{DS} = V_{GS}$ $I_D = 1 \text{ mA}$, $V_{DS} = V_{GS}$
	IRF120-123/IRF520-523	2.0	4.0		
	MTP10N08/10N10	2.0	4.5		
$R_{DS(on)}$	Static Drain-Source On-Resistance ²			Ω	$V_{GS} = 10 \text{ V}$
	IRF120/121/520/521		0.30		$I_D = 4.0 \text{ A}$
	MTP10N08/10N10		0.33		$I_D = 5.0 \text{ A}$
	IRF122/123/522/523		0.40		$I_D = 4.0 \text{ A}$
$V_{DS(on)}$	Drain-Source On-Voltage ²		4.0	V	$V_{GS} = 10 \text{ V}$; $I_D = 10.0 \text{ A}$
	MTP 10N08/10N10		3.3	V	$V_{GS} = 10 \text{ V}$, $I_D = 5.0 \text{ A}$ $T_C = 100^\circ\text{C}$
g_{fs}	Forward Transconductance	1.5		S (Ω)	$V_{DS} = 10 \text{ V}$, $I_D = 4.0 \text{ A}$

Dynamic Characteristics

C_{iss}	Input Capacitance		600	pF	$V_{DS} = 25 \text{ V}$, $V_{GS} = 0 \text{ V}$ $f = 1.0 \text{ MHz}$
C_{oss}	Output Capacitance		400	pF	
C_{rss}	Reverse Transfer Capacitance		100	pF	

Switching Characteristics ($T_C = 25^\circ\text{C}$, Figures 1, 2)³

$t_{d(on)}$	Turn-On Delay Time		40	ns	$V_{DD} = 50 \text{ V}$, $I_D = 4.0 \text{ A}$ $V_{GS} = 10 \text{ V}$, $R_{GEN} = 50 \Omega$ $R_{GS} = 50 \Omega$
t_r	Rise Time		70	ns	
$t_{d(off)}$	Turn-Off Delay Time		100	ns	
t_f	Fall Time		70	ns	
Q_g	Total Gate Charge		15	nC	$V_{GS} = 10 \text{ V}$, $I_D = 10 \text{ A}$ $V_{DD} = 50 \text{ V}$

Symbol	Characteristic	Typ	Max	Unit	Test Conditions
Source-Drain Diode Characteristics					
V_{SD}	Diode Forward Voltage		2.5	V	$I_S = 8.0 \text{ A}$; $V_{GS} = 0 \text{ V}$
	IRF120/121/520/521		2.3	V	$I_S = 7.0 \text{ A}$; $V_{GS} = 0 \text{ V}$
t_{rr}	Reverse Recovery Time	280		ns	$I_S = 4.0 \text{ A}$; $di_S/dt = 25 \text{ A}/\mu\text{S}$

Notes

- $T_J = +25^\circ\text{C}$ to $+150^\circ\text{C}$
- Pulse width limited by T_J
- Switching time measurements performed on LEM TR-58 test equipment.

IRF120-123/IRF520-523
MTP10N08/10N10

T-39-11

Typical Electrical Characteristics

Figure 1 Switching Test Circuit

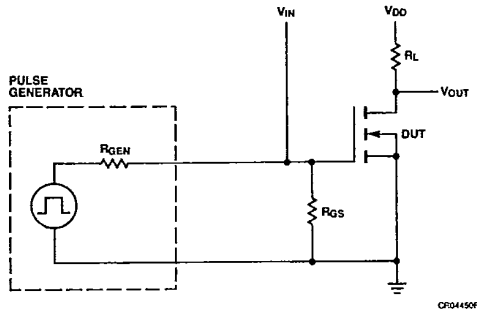
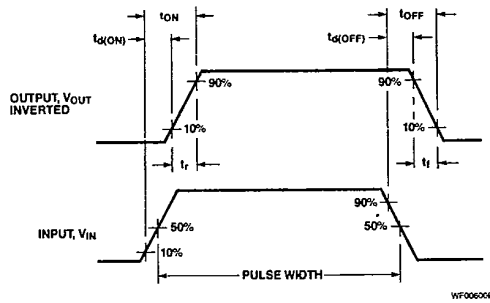

Figure 2 Switching Waveforms



Typical Performance Curves

Figure 3 Output Characteristics

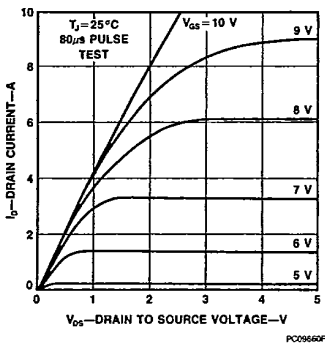

Figure 4 Static Drain to Source Resistance vs Drain Current

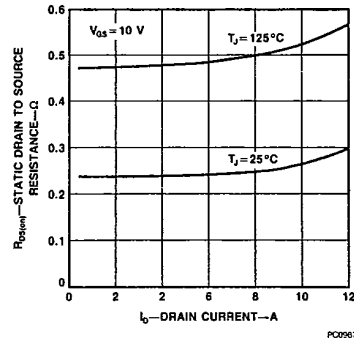

Figure 5 Transfer Characteristics

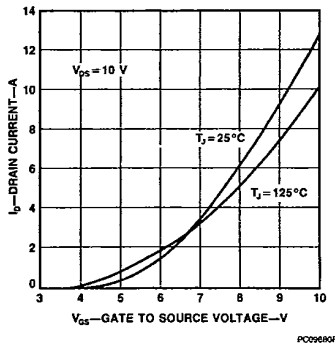
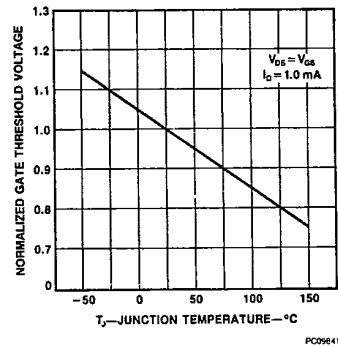

Figure 6 Temperature Variation of Gate to Source Threshold Voltage



IRF120-123/IRF520-523
MTP10N08/10N10

T-39-11

Typical Performance Curves (Cont.)

Figure 7 Capacitance vs Drain to Source Voltage

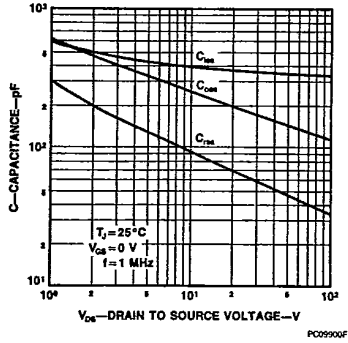

Figure 8 Gate to Source Voltage vs Total Gate Charge

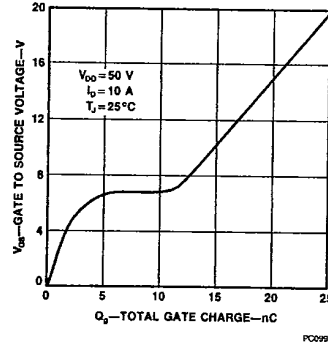

Figure 9 Forward Biased Safe Operating Area for IRF120-123 And IRF520-523

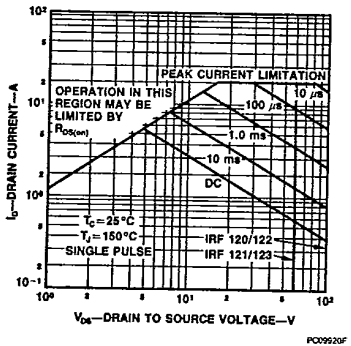

Figure 10 Transient Thermal Resistance vs Time for IRF120-123 And IRF520-523

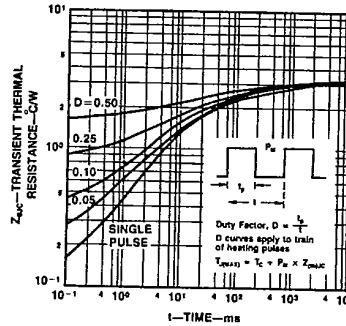

Figure 11 Forward Biased Safe Operating Area for MTP10N08/10N10

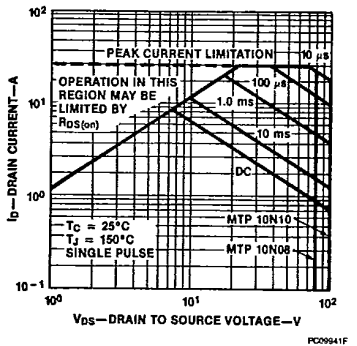

Figure 12 Transient Thermal Resistance vs Time for MTP10N08/10N10

