

## Power MOSFET



N-Channel MOSFET

### FEATURES

- Dynamic dV/dt rating
- Repetitive avalanche rated
- 175 °C operating temperature
- Fast switching
- Ease of paralleling
- Simple drive requirements
- Material categorization: for definitions of compliance please see [www.vishay.com/doc?99912](http://www.vishay.com/doc?99912)



### Note

\* This datasheet provides information about parts that are RoHS-compliant and / or parts that are non RoHS-compliant. For example, parts with lead (Pb) terminations are not RoHS-compliant. Please see the information / tables in this datasheet for details

PRODUCT SUMMARY	
$V_{DS}$ (V)	100
$R_{DS(on)}$ ( $\Omega$ )	$V_{GS} = 10\text{ V}$ 0.077
$Q_g$ max. (nC)	72
$Q_{gs}$ (nC)	11
$Q_{gd}$ (nC)	32
Configuration	Single

### DESCRIPTION

Third generation power MOSFETs from Vishay provide the designer with the best combination of fast switching, ruggedized device design, low on-resistance and cost-effectiveness.

The TO-220AB package is universally preferred for all commercial-industrial applications at power dissipation levels to approximately 50 W. The low thermal resistance and low package cost of the TO-220AB contribute to its wide acceptance throughout the industry.



ORDERING INFORMATION	
Package	TO-220AB
Lead (Pb)-free	IRF540PbF
Lead (Pb)-free and halogen-free	IRF540PbF-BE3

ABSOLUTE MAXIMUM RATINGS ( $T_C = 25\text{ }^\circ\text{C}$ , unless otherwise noted)				
PARAMETER		SYMBOL	LIMIT	UNIT
Drain-source voltage		$V_{DS}$	100	V
Gate-source voltage		$V_{GS}$	$\pm 20$	
Continuous drain current	$V_{GS}$ at 10 V	$I_D$	$T_C = 25\text{ }^\circ\text{C}$	A
			$T_C = 100\text{ }^\circ\text{C}$	
Pulsed drain current <sup>a</sup>		$I_{DM}$	110	
Linear derating factor			1.0	W/ $^\circ\text{C}$
Single pulse avalanche energy <sup>b</sup>		$E_{AS}$	230	mJ
Repetitive avalanche current <sup>a</sup>		$I_{AR}$	28	A
Repetitive avalanche energy <sup>a</sup>		$E_{AR}$	15	mJ
Maximum power dissipation	$T_C = 25\text{ }^\circ\text{C}$	$P_D$	150	W
Peak diode recovery dV/dt <sup>c</sup>		dV/dt	5.5	V/ns
Operating junction and storage temperature range		$T_J, T_{stg}$	-55 to +175	$^\circ\text{C}$
Soldering recommendations (peak temperature) <sup>d</sup>	For 10 s		300	
Mounting torque	6-32 or M3 screw		10	
			1.1	N · m

### Notes

- Repetitive rating; pulse width limited by maximum junction temperature (see fig. 11)
- $V_{DD} = 25\text{ V}$ , starting  $T_J = 25\text{ }^\circ\text{C}$ ,  $L = 440\text{ }\mu\text{H}$ ,  $R_g = 25\text{ }\Omega$ ,  $I_{AS} = 28\text{ A}$  (see fig. 12)
- $I_{SD} \leq 28\text{ A}$ ,  $dI/dt \leq 170\text{ A}/\mu\text{s}$ ,  $V_{DD} \leq V_{DS}$ ,  $T_J \leq 175\text{ }^\circ\text{C}$
- 1.6 mm from case

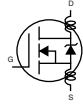
THERMAL RESISTANCE RATINGS				
PARAMETER	SYMBOL	TYP.	MAX.	UNIT
Maximum junction-to-ambient	$R_{thJA}$	-	62	°C/W
Case-to-sink, flat, greased surface	$R_{thCS}$	0.50	-	
Maximum junction-to-case (drain)	$R_{thJC}$	-	1.0	

SPECIFICATIONS ( $T_J = 25\text{ }^\circ\text{C}$ , unless otherwise noted)						
PARAMETER	SYMBOL	TEST CONDITIONS	MIN.	TYP.	MAX.	UNIT
<b>Static</b>						
Drain-source breakdown voltage	$V_{DS}$	$V_{GS} = 0\text{ V}$ , $I_D = 250\text{ }\mu\text{A}$	100	-	-	V
$V_{DS}$ temperature coefficient	$\Delta V_{DS}/T_J$	Reference to $25\text{ }^\circ\text{C}$ , $I_D = 1\text{ mA}$	-	0.13	-	V/°C
Gate-source threshold voltage	$V_{GS(th)}$	$V_{DS} = V_{GS}$ , $I_D = 250\text{ }\mu\text{A}$	2.0	-	4.0	V
Gate-source leakage	$I_{GSS}$	$V_{GS} = \pm 20\text{ V}$	-	-	$\pm 100$	nA
Zero gate voltage drain current	$I_{DSS}$	$V_{DS} = 100\text{ V}$ , $V_{GS} = 0\text{ V}$	-	-	25	$\mu\text{A}$
		$V_{DS} = 80\text{ V}$ , $V_{GS} = 0\text{ V}$ , $T_J = 150\text{ }^\circ\text{C}$	-	-	250	
Drain-source on-state resistance	$R_{DS(on)}$	$V_{GS} = 10\text{ V}$   $I_D = 17\text{ A}^b$	-	-	0.077	$\Omega$
Forward transconductance	$g_{fs}$	$V_{DS} = 50\text{ V}$ , $I_D = 17\text{ A}^b$	8.7	-	-	S
<b>Dynamic</b>						
Input capacitance	$C_{iss}$	$V_{GS} = 0\text{ V}$ , $V_{DS} = 25\text{ V}$ , $f = 1.0\text{ MHz}$ , see fig. 5	-	1700	-	$\mu\text{F}$
Output capacitance	$C_{oss}$		-	560	-	
Reverse transfer capacitance	$C_{rss}$		-	120	-	
Total gate charge	$Q_g$	$V_{GS} = 10\text{ V}$   $I_D = 17\text{ A}$ , $V_{DS} = 80\text{ V}$ , see fig. 6 and 13 <sup>b</sup>	-	-	72	nC
Gate-source charge	$Q_{gs}$		-	-	11	
Gate-drain charge	$Q_{gd}$		-	-	32	
Turn-on delay time	$t_{d(on)}$	$V_{DD} = 50\text{ V}$ , $I_D = 17\text{ A}$ $R_g = 9.1\text{ }\Omega$ , $R_D = 2.9\text{ }\Omega$ , see fig. 10 <sup>b</sup>	-	11	-	ns
Rise time	$t_r$		-	44	-	
Turn-off delay time	$t_{d(off)}$		-	53	-	
Fall time	$t_f$		-	43	-	
Gate input resistance	$R_g$	$f = 1\text{ MHz}$ , open drain	0.5	-	3.6	$\Omega$
Internal drain inductance	$L_D$	Between lead, 6 mm (0.25") from package and center of die contact 	-	4.5	-	nH
Internal source inductance	$L_S$		-	7.5	-	
<b>Drain-Source Body Diode Characteristics</b>						
Continuous source-drain diode current	$I_S$	MOSFET symbol showing the integral reverse p - n junction diode 	-	-	28	A
Pulsed diode forward current <sup>a</sup>	$I_{SM}$		-	-	110	
Body diode voltage	$V_{SD}$	$T_J = 25\text{ }^\circ\text{C}$ , $I_S = 28\text{ A}$ , $V_{GS} = 0\text{ V}^b$	-	-	2.5	V
Body diode reverse recovery time	$t_{rr}$	$T_J = 25\text{ }^\circ\text{C}$ , $I_F = 17\text{ A}$ , $dI/dt = 100\text{ A}/\mu\text{s}^b$	-	180	360	ns
Body diode reverse recovery charge	$Q_{rr}$		-	1.3	2.8	$\mu\text{C}$
Forward turn-on time	$t_{on}$	Intrinsic turn-on time is negligible (turn-on is dominated by $L_S$ and $L_D$ )				

**Notes**

- a. Repetitive rating; pulse width limited by maximum junction temperature (see fig. 11)  
 b. Pulse width  $\leq 300\text{ }\mu\text{s}$ ; duty cycle  $\leq 2\%$

**TYPICAL CHARACTERISTICS** (25 °C, unless otherwise noted)

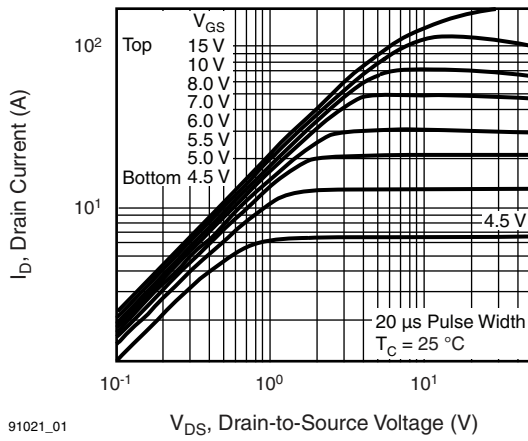

91021\_01

**Fig. 1 - Typical Output Characteristics,  $T_C = 25\text{ }^\circ\text{C}$**

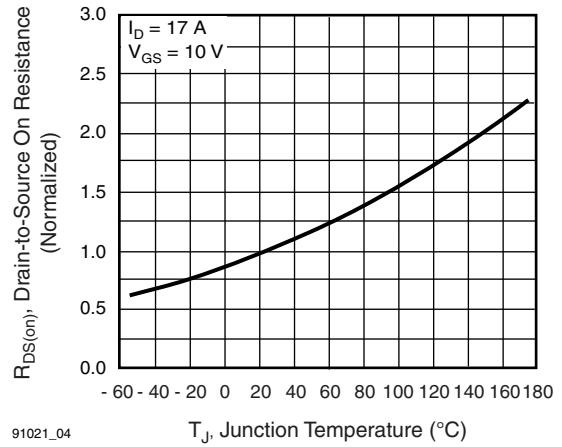

91021\_04

**Fig. 4 - Normalized On-Resistance vs. Temperature**

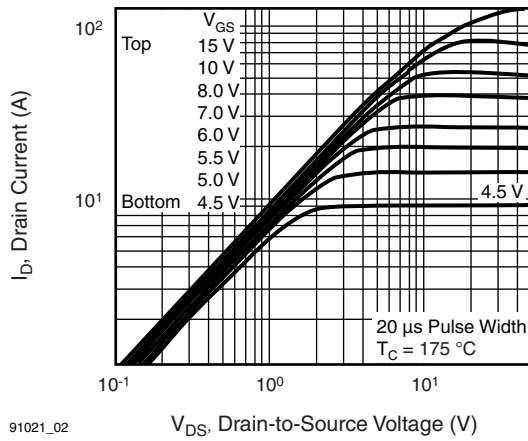

91021\_02

**Fig. 2 - Typical Output Characteristics,  $T_C = 175\text{ }^\circ\text{C}$**

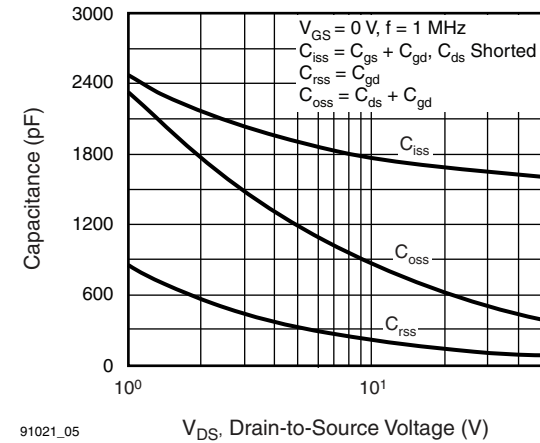

91021\_05

**Fig. 5 - Typical Capacitance vs. Drain-to-Source Voltage**

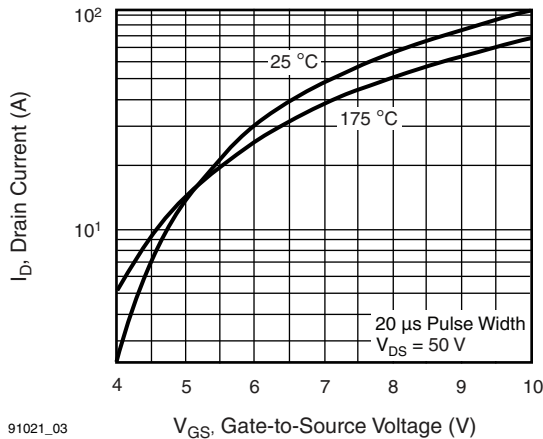

91021\_03

**Fig. 3 - Typical Transfer Characteristics**

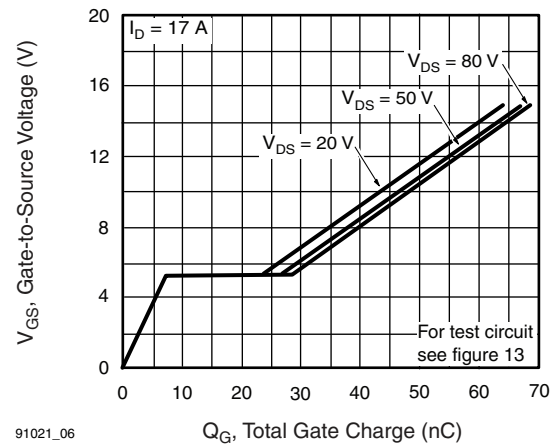

91021\_06

**Fig. 6 - Typical Gate Charge vs. Gate-to-Source Voltage**

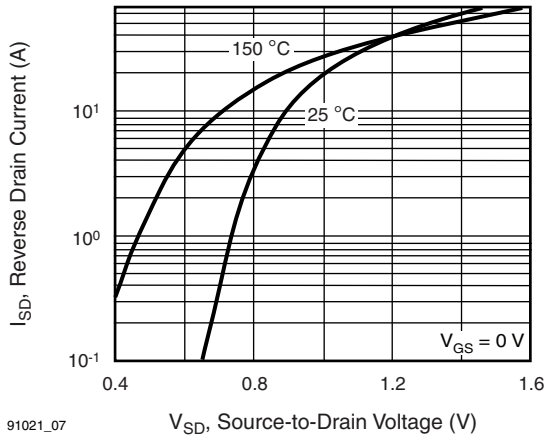

Fig. 7 - Typical Source-Drain Diode Forward Voltage

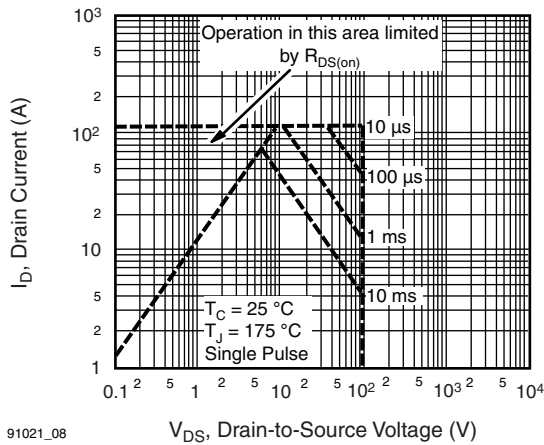

Fig. 8 - Maximum Safe Operating Area

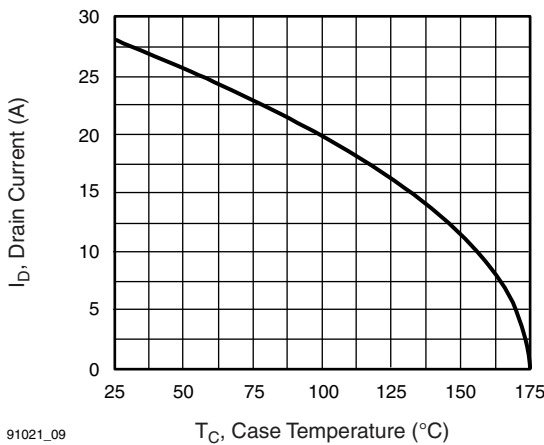

Fig. 9 - Maximum Drain Current vs. Case Temperature

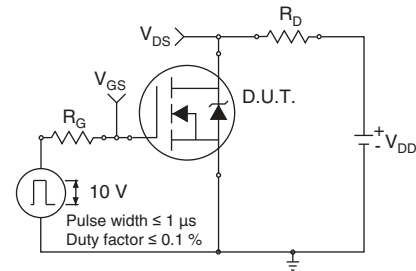

Fig. 10a - Switching Time Test Circuit

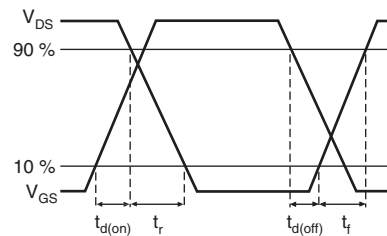

Fig. 10b - Switching Time Waveforms

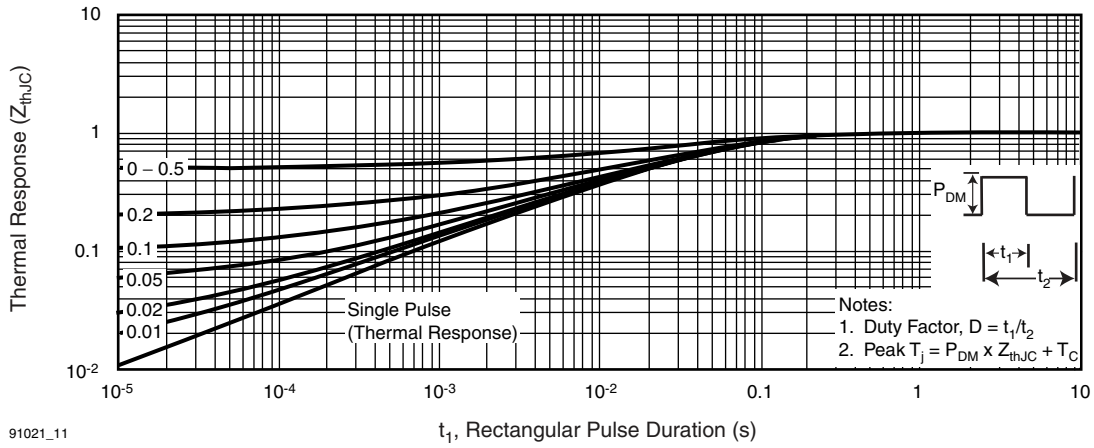

Fig. 11 - Maximum Effective Transient Thermal Impedance, Junction-to-Case

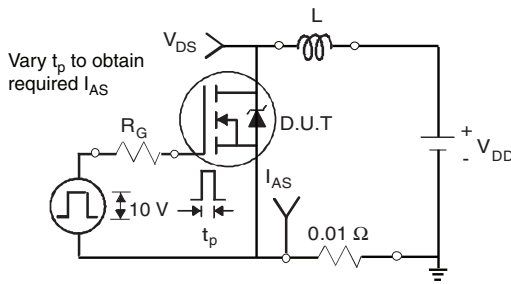

Fig. 12a - Unclamped Inductive Test Circuit

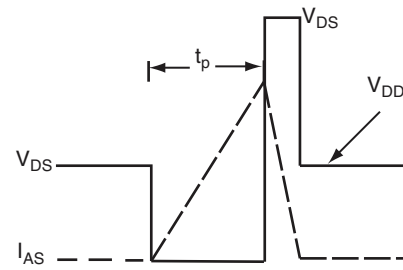

Fig. 12b - Unclamped Inductive Waveforms

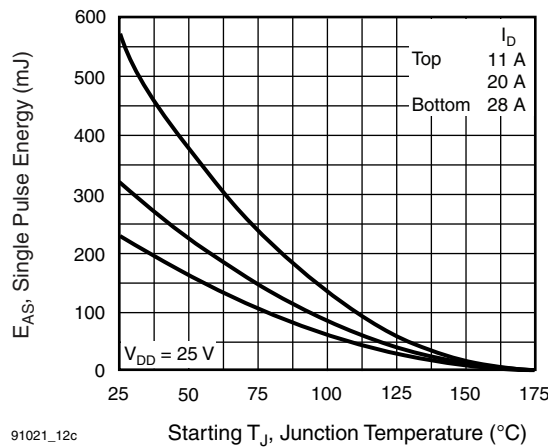

Fig. 12c - Maximum Avalanche Energy vs. Drain Current



Fig. 13a - Basic Gate Charge Waveform



Fig. 13b - Gate Charge Test Circuit

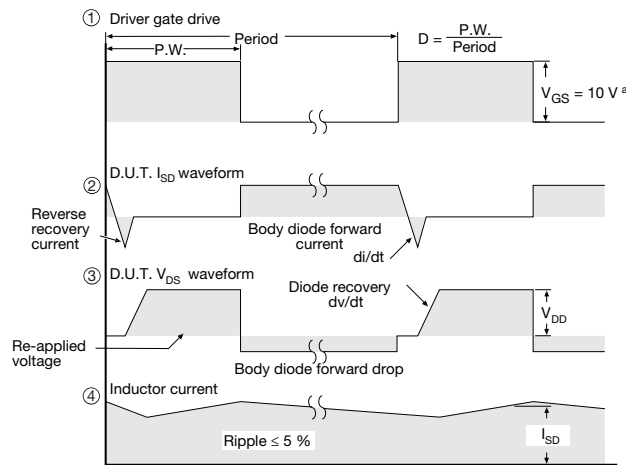
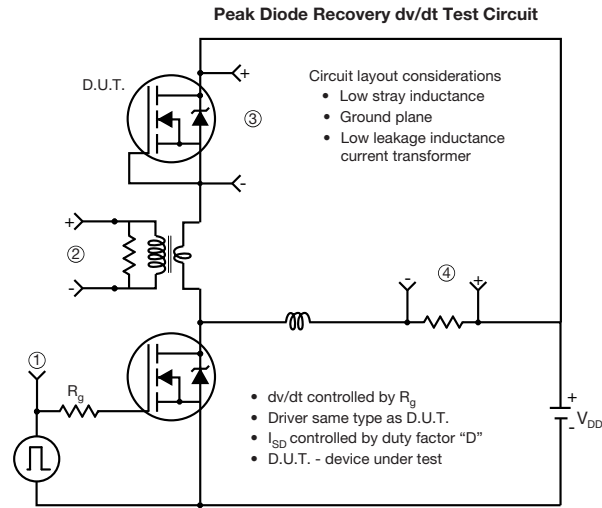

Note  
a.  $V_{GS} = 5V$  for logic level devices

Fig. 14 - For N-Channel

Vishay Siliconix maintains worldwide manufacturing capability. Products may be manufactured at one of several qualified locations. Reliability data for Silicon Technology and Package Reliability represent a composite of all qualified locations. For related documents such as package/tape drawings, part marking, and reliability data, see <http://www.vishay.com/ppg?91021>.

## TO-220-1



DIM.	MILLIMETERS		INCHES	
	MIN.	MAX.	MIN.	MAX.
A	4.24	4.65	0.167	0.183
b	0.69	1.02	0.027	0.040
b(1)	1.14	1.78	0.045	0.070
c	0.36	0.61	0.014	0.024
D	14.33	15.85	0.564	0.624
E	9.96	10.52	0.392	0.414
e	2.41	2.67	0.095	0.105
e(1)	4.88	5.28	0.192	0.208
F	1.14	1.40	0.045	0.055
H(1)	6.10	6.71	0.240	0.264
J(1)	2.41	2.92	0.095	0.115
L	13.36	14.40	0.526	0.567
L(1)	3.33	4.04	0.131	0.159
Ø P	3.53	3.94	0.139	0.155
Q	2.54	3.00	0.100	0.118

ECN: X15-0364-Rev. C, 14-Dec-15  
DWG: 6031

**Note**

- M\* = 0.052 inches to 0.064 inches (dimension including protrusion), heatsink hole for HVM





## Disclaimer

ALL PRODUCT, PRODUCT SPECIFICATIONS AND DATA ARE SUBJECT TO CHANGE WITHOUT NOTICE TO IMPROVE RELIABILITY, FUNCTION OR DESIGN OR OTHERWISE.

Vishay Intertechnology, Inc., its affiliates, agents, and employees, and all persons acting on its or their behalf (collectively, "Vishay"), disclaim any and all liability for any errors, inaccuracies or incompleteness contained in any datasheet or in any other disclosure relating to any product.

Vishay makes no warranty, representation or guarantee regarding the suitability of the products for any particular purpose or the continuing production of any product. To the maximum extent permitted by applicable law, Vishay disclaims (i) any and all liability arising out of the application or use of any product, (ii) any and all liability, including without limitation special, consequential or incidental damages, and (iii) any and all implied warranties, including warranties of fitness for particular purpose, non-infringement and merchantability.

Statements regarding the suitability of products for certain types of applications are based on Vishay's knowledge of typical requirements that are often placed on Vishay products in generic applications. Such statements are not binding statements about the suitability of products for a particular application. It is the customer's responsibility to validate that a particular product with the properties described in the product specification is suitable for use in a particular application. Parameters provided in datasheets and / or specifications may vary in different applications and performance may vary over time. All operating parameters, including typical parameters, must be validated for each customer application by the customer's technical experts. Product specifications do not expand or otherwise modify Vishay's terms and conditions of purchase, including but not limited to the warranty expressed therein.

Hyperlinks included in this datasheet may direct users to third-party websites. These links are provided as a convenience and for informational purposes only. Inclusion of these hyperlinks does not constitute an endorsement or an approval by Vishay of any of the products, services or opinions of the corporation, organization or individual associated with the third-party website. Vishay disclaims any and all liability and bears no responsibility for the accuracy, legality or content of the third-party website or for that of subsequent links.

Except as expressly indicated in writing, Vishay products are not designed for use in medical, life-saving, or life-sustaining applications or for any other application in which the failure of the Vishay product could result in personal injury or death. Customers using or selling Vishay products not expressly indicated for use in such applications do so at their own risk. Please contact authorized Vishay personnel to obtain written terms and conditions regarding products designed for such applications.

No license, express or implied, by estoppel or otherwise, to any intellectual property rights is granted by this document or by any conduct of Vishay. Product names and markings noted herein may be trademarks of their respective owners.