

# IRF6100PbF

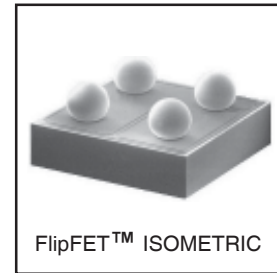
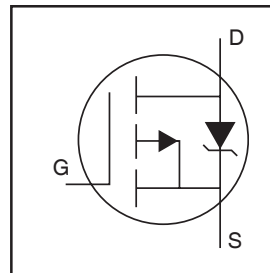
HEXFET<sup>®</sup> Power MOSFET

- Ultra Low  $R_{DS(on)}$  per Footprint Area
- Low Thermal Resistance
- P-Channel MOSFET
- One-third Footprint of SOT-23
- Super Low Profile (<.8mm)
- Available Tested on Tape & Reel
- Lead-Free

$V_{DSS}$	$R_{DS(on)}$ max	$I_D$
-20V	0.065 $\Omega$ @ $V_{GS} = -4.5V$	-5.1A
	0.095 $\Omega$ @ $V_{GS} = -2.5V$	-4.1A

## Description

True chip-scale packaging is available from International Rectifier. Through the use of advanced processing techniques, and a unique packaging concept, extremely low on-resistance and the highest power densities in the industry have been made available for battery and load management applications. These benefits, combined with the ruggedized device design, that International Rectifier is well known for, provides the designer with an extremely efficient and reliable device.



The FlipFET<sup>™</sup> package, is one-third the footprint of a comparable SOT-23 package and has a profile of less than .8mm. Combined with the low thermal resistance of the die level device, this makes the FlipFET<sup>™</sup> the best device for application where printed circuit board space is at a premium and in extremely thin application environments such as battery packs, cell phones and PCMCIA cards.

## Absolute Maximum Ratings

	Parameter	Max.	Units
$V_{DS}$	Drain- Source Voltage	-20	V
$I_D @ T_A = 25^\circ C$	Continuous Drain Current, $V_{GS} @ 4.5V$	$\pm 5.1$	A
$I_D @ T_A = 70^\circ C$	Continuous Drain Current, $V_{GS} @ 4.5V$	$\pm 3.5$	
$I_{DM}$	Pulsed Drain Current ①	$\pm 35$	
$P_D @ T_A = 25^\circ C$	Power Dissipation ③	2.2	W
$P_D @ T_A = 70^\circ C$	Power Dissipation ③	1.4	
	Linear Derating Factor	17	mW/ $^\circ C$
$V_{GS}$	Gate-to-Source Voltage	$\pm 12$	V
$T_J, T_{STG}$	Junction and Storage Temperature Range	-55 to + 150	$^\circ C$

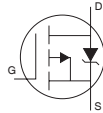
## Thermal Resistance

Symbol	Parameter	Typ.	Max.	Units
$R_{\theta JA}$	Junction-to-Ambient ③		56.5	$^\circ C/W$
$R_{\theta J-PCB}$	Junction-to-PCB mounted	35	—	

## Electrical Characteristics @ $T_J = 25^\circ\text{C}$ (unless otherwise specified)

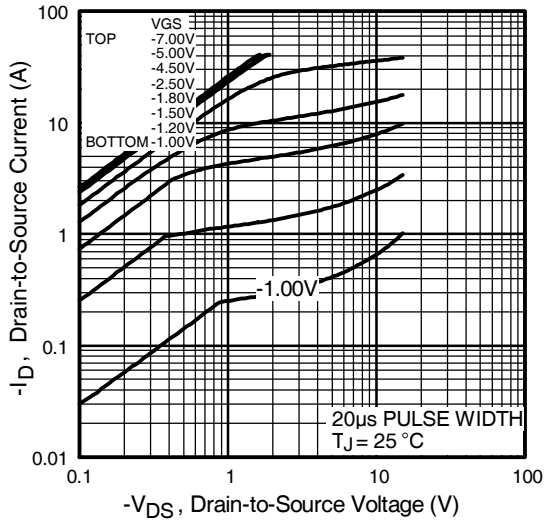
	Parameter	Min.	Typ.	Max.	Units	Conditions
$V_{(BR)DSS}$	Drain-to-Source Breakdown Voltage	-20	—	—	V	$V_{GS} = 0V, I_D = -250\mu A$
$\Delta V_{(BR)DSS}/\Delta T_J$	Breakdown Voltage Temp. Coefficient	—	-0.010	—	V/°C	Reference to $25^\circ\text{C}$ , $I_D = -1\text{mA}$
$R_{DS(on)}$	Static Drain-to-Source On-Resistance	—	—	0.065	$\Omega$	$V_{GS} = -4.5V, I_D = -5.1A$ ②
		—	—	0.095		$V_{GS} = -2.5V, I_D = -4.1A$ ②
$V_{GS(th)}$	Gate Threshold Voltage	-0.45	—	-1.2	V	$V_{DS} = V_{GS}, I_D = -250\mu A$
$g_{fs}$	Forward Transconductance	9.8	—	—	S	$V_{DS} = -10V, I_D = -5.1A$
$I_{DSS}$	Drain-to-Source Leakage Current	—	—	-1.0	$\mu A$	$V_{DS} = -20V, V_{GS} = 0V$
		—	—	-25		$V_{DS} = -16V, V_{GS} = 0V, T_J = 125^\circ\text{C}$
$I_{GSS}$	Gate-to-Source Forward Leakage	—	—	100	nA	$V_{GS} = 12V$
	Gate-to-Source Reverse Leakage	—	—	-100		$V_{GS} = -12V$
$Q_g$	Total Gate Charge	—	14	21	nC	$I_D = -5.1A$
$Q_{gs}$	Gate-to-Source Charge	—	1.9	2.9		$V_{DS} = -16V$
$Q_{gd}$	Gate-to-Drain ("Miller") Charge	—	5.0	7.5		$V_{GS} = -5.0V$
$t_{d(on)}$	Turn-On Delay Time	—	12	—	ns	$V_{DD} = -10V$
$t_r$	Rise Time	—	12	—		$I_D = -1.0A$
$t_{d(off)}$	Turn-Off Delay Time	—	50	—		$R_G = 5.8\Omega$
$t_f$	Fall Time	—	50	—		$V_{GS} = -4.5V$ ②
$C_{iss}$	Input Capacitance	—	1230	—	pF	$V_{GS} = 0V$
$C_{oss}$	Output Capacitance	—	250	—		$V_{DS} = -15V$
$C_{rss}$	Reverse Transfer Capacitance	—	180	—		$f = 1.0\text{MHz}$ , See Fig. 5

## Source-Drain Ratings and Characteristics

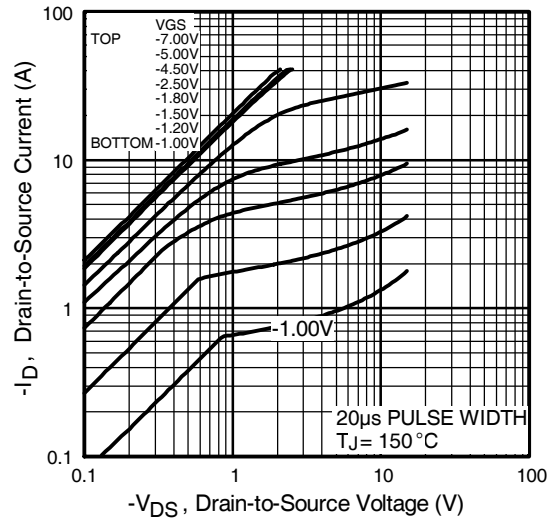
	Parameter	Min.	Typ.	Max.	Units	Conditions
$I_S$	Continuous Source Current (Body Diode)	—	—	-2.2	A	MOSFET symbol showing the integral reverse p-n junction diode. 
$I_{SM}$	Pulsed Source Current (Body Diode) ①	—	—	-33		
$V_{SD}$	Diode Forward Voltage	—	—	-1.2	V	$T_J = 25^\circ\text{C}, I_S = -2.2A, V_{GS} = 0V$ ②
$t_{rr}$	Reverse Recovery Time	—	48	72	ns	$T_J = 25^\circ\text{C}, I_F = -2.2A$
$Q_{rr}$	Reverse Recovery Charge	—	34	51	nC	$di/dt = 100A/\mu s$ ②

### Notes:

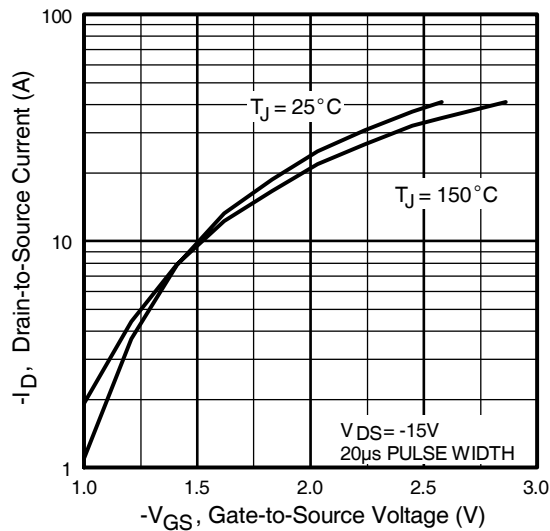
- ① Repetitive rating; pulse width limited by max. junction temperature.      ③ When mounted on 1 inch square 2oz copper on FR-4.
- ② Pulse width  $\leq 400\mu s$ ; duty cycle  $\leq 2\%$ .



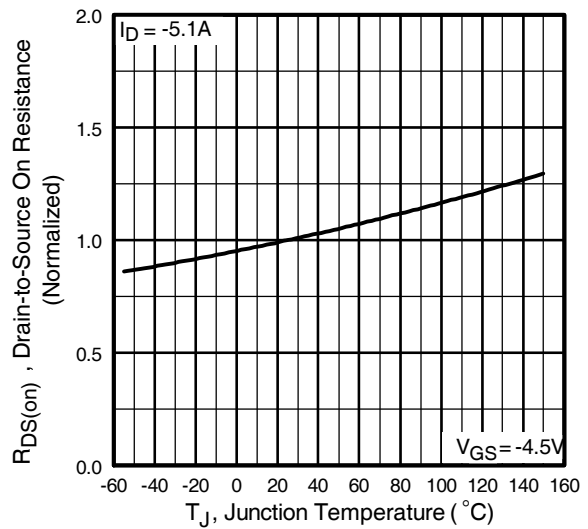
**Fig 1.** Typical Output Characteristics



**Fig 2.** Typical Output Characteristics

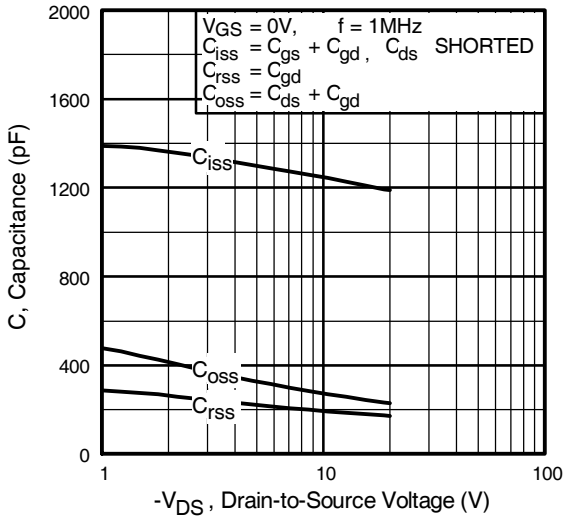


**Fig 3.** Typical Transfer Characteristics

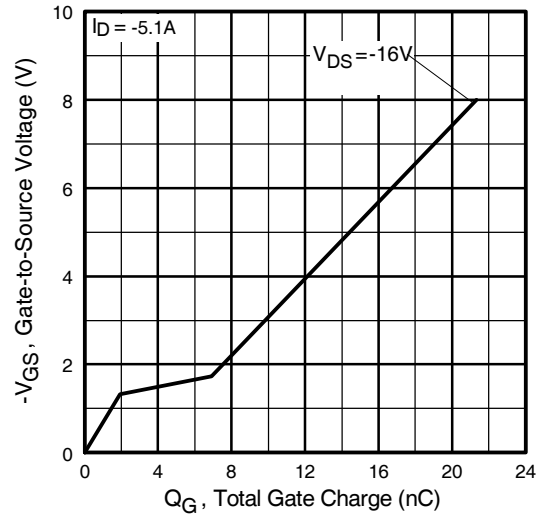


**Fig 4.** Normalized On-Resistance Vs. Temperature

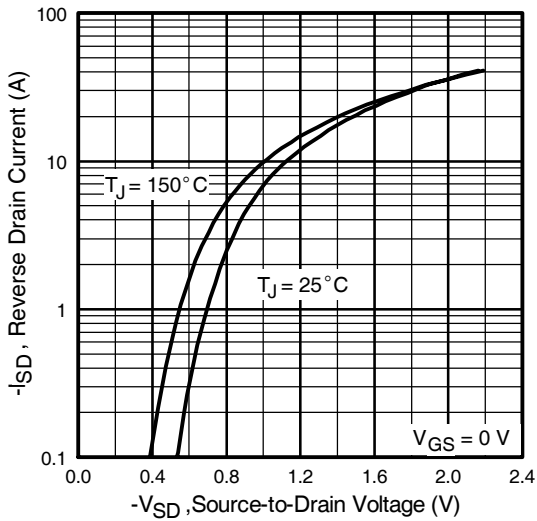
# IRF6100PbF



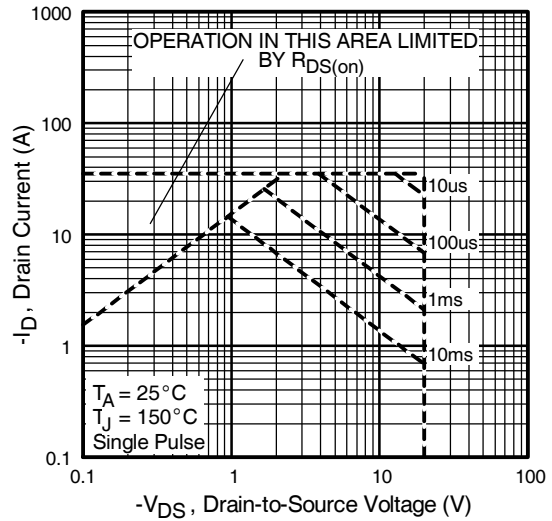
**Fig 5.** Typical Capacitance Vs. Drain-to-Source Voltage



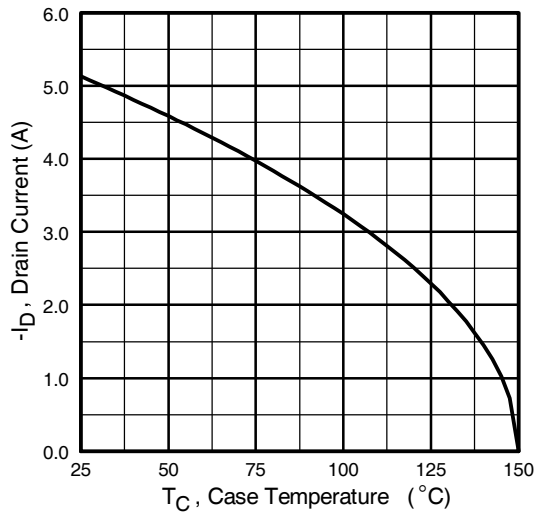
**Fig 6.** Typical Gate Charge Vs. Gate-to-Source Voltage



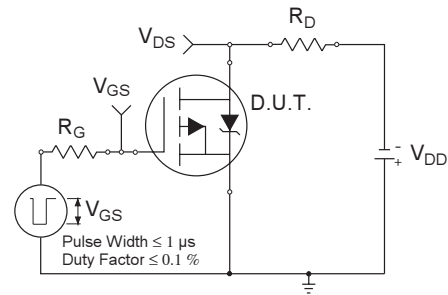
**Fig 7.** Typical Source-Drain Diode Forward Voltage



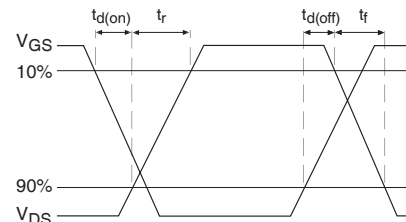
**Fig 8.** Maximum Safe Operating Area



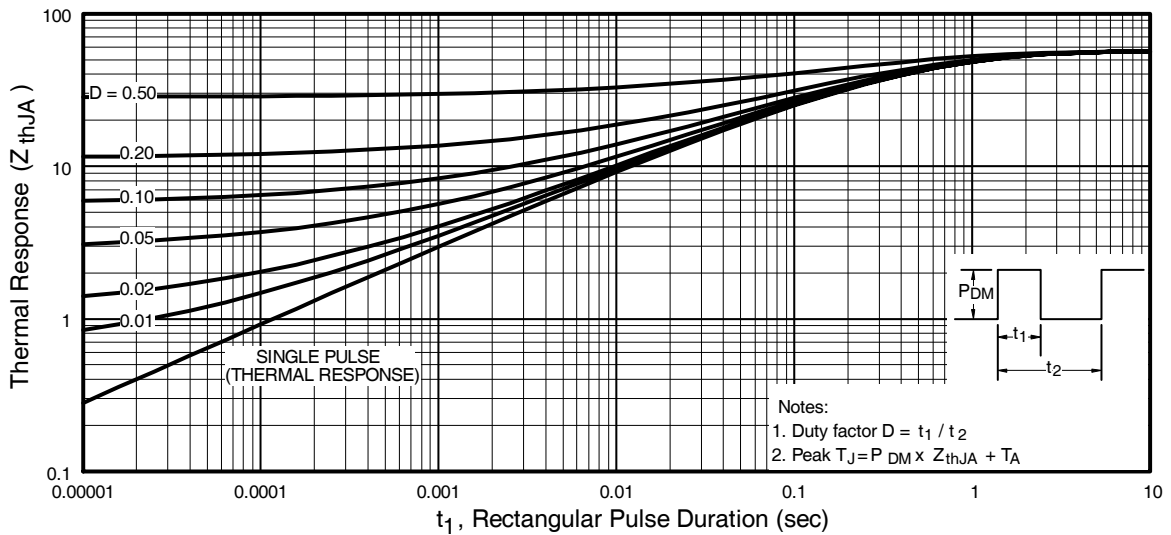
**Fig 9.** Maximum Drain Current Vs. Case Temperature



**Fig 10a.** Switching Time Test Circuit



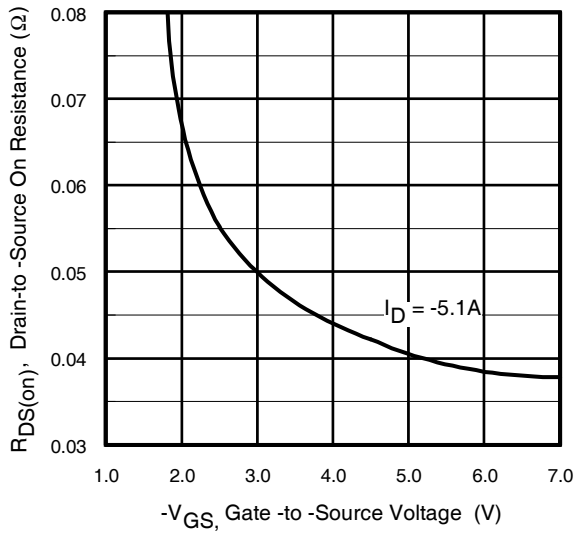
**Fig 10b.** Switching Time Waveforms



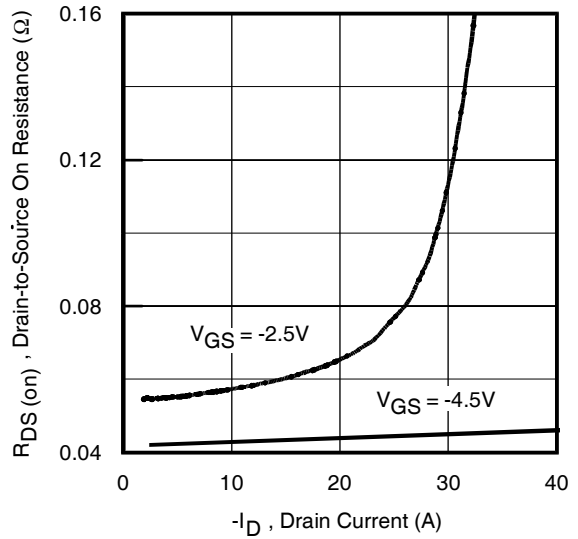
**Fig 11.** Maximum Effective Transient Thermal Impedance, Junction-to-Ambient

# IRF6100PbF

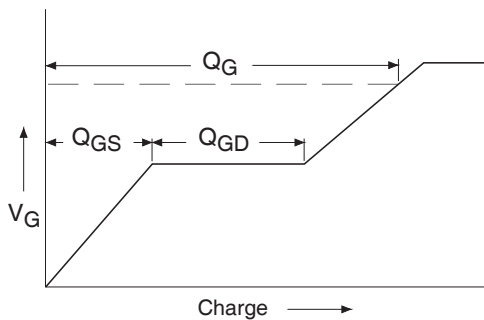
International  
**IR** Rectifier



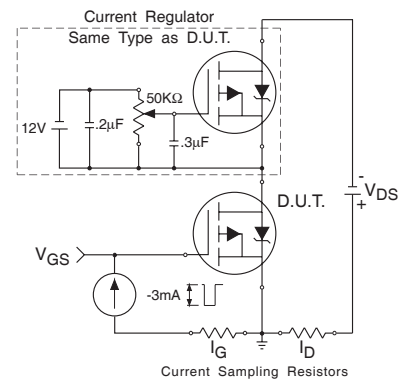
**Fig 12.** Typical On-Resistance Vs. Gate Voltage



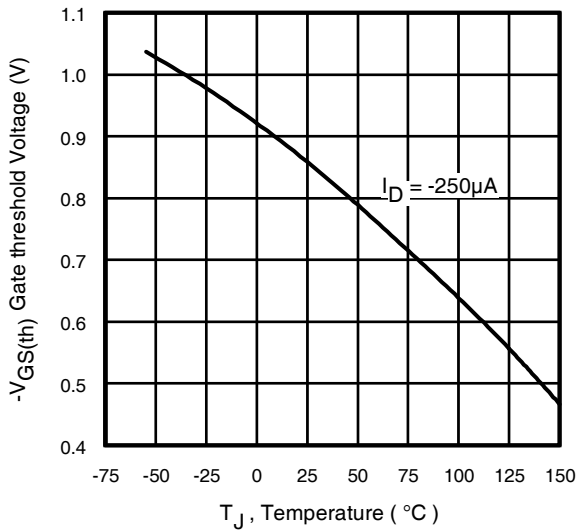
**Fig 13.** Typical On-Resistance Vs. Drain Current



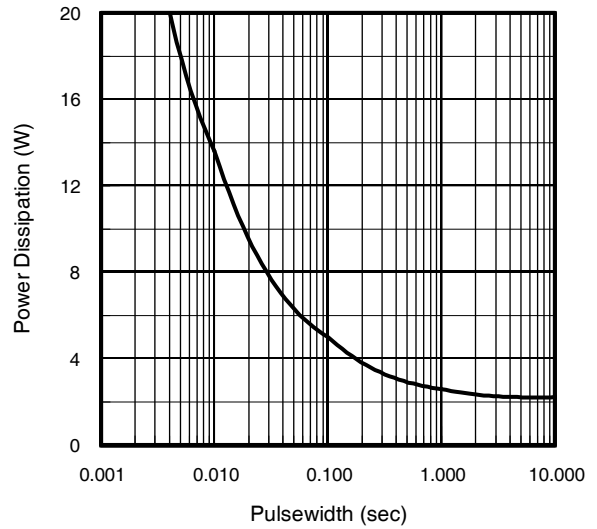
**Fig 14a.** Basic Gate Charge Waveform



**Fig 14b.** Gate Charge Test Circuit



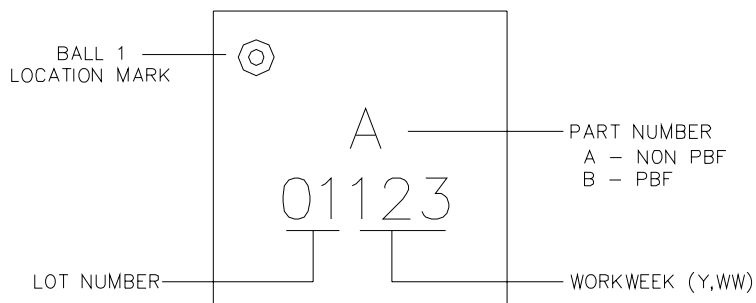
**Fig 15.** Threshold Voltage Vs. Temperature



**Fig 16.** Maximum Power Dissipation Vs. Time

## FlipFET™ Part Marking Information

### LAYOUT MARKING A



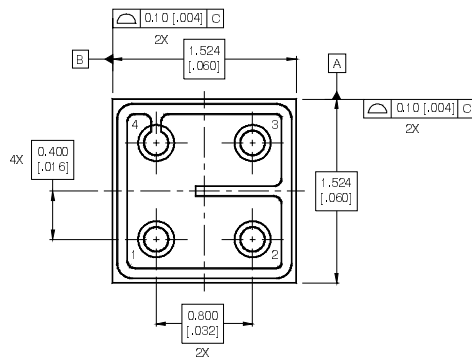
# IRF6100PbF

International  
**IR** Rectifier

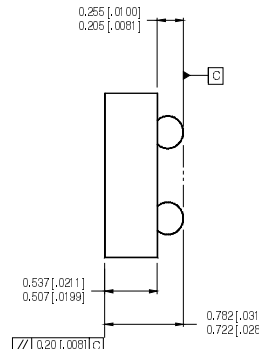
## FlipFET™ Outline Dimension and Tape and Reel

(Refer to application note AN-1011 for details about board mounting the 0.8mm ball pitch Flip FET)

NOTES:  
1. DIMENSIONS & TOLERANCES PER ASME Y14.5M-1994.  
2. CONTROLLING DIMENSION: MILLIMETER.  
3. DIMENSIONS ARE SHOWN IN MILLIMETERS (INCHES).



BOTTOM VIEW



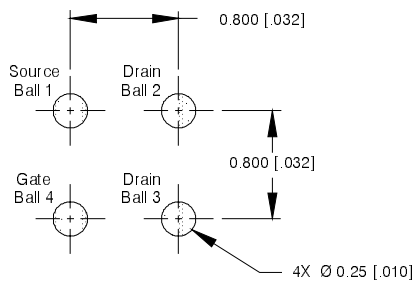
SIDE VIEW

**BALL ASSIGNMENTS**

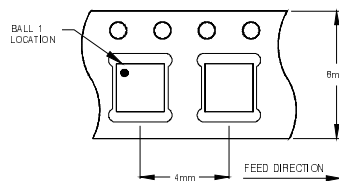
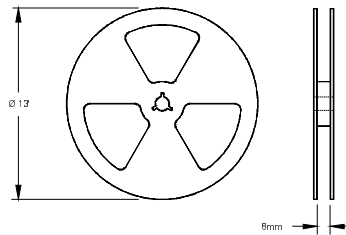
- 1 = SOURCE
- 2 = DRAIN
- 3 = DRAIN
- 4 = GATE

**LEAD-FREE SOLDER BALL COMPOSITION**

- 95.9% Sn
- 3.8% Ag
- 0.7% Cu



RECOMMENDED FOOTPRINT



NOTES:  
1. TAPE AND REEL OUTLINE CONFORMS TO EA-481 & EA-541.

### Tape and Reel

Data and specifications subject to change without notice.  
This product has been designed and qualified for the Consumer market.  
Qualification Standards can be found on IR's Web site.

International  
**IR** Rectifier

IR WORLD HEADQUARTERS: 233 Kansas St., El Segundo, California 90245, USA Tel: (310) 252-7105

TAC Fax: (310) 252-7903

Visit us at [www.irf.com](http://www.irf.com) for sales contact information.05/06

[www.irf.com](http://www.irf.com)