

N-Channel Enhancement Mode POWER MOSFET

(Pb) Lead(Pb)-Free

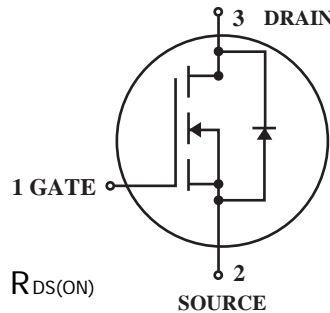

DRAIN CURRENT

18 AMPERES

DRAIN SOURCE VOLTAGE

200 VOLTAGE

Features:

- * Super High Dense Cell Design For Low $R_{DS(ON)}$
 $R_{DS(ON)} < 0.18\Omega @ V_{GS} = 10V$
- * Single Pulse Avalanche Energy Rated
- * SOA is Power Dissipation Limited
- * Nanosecond Switching Speed
- * Linear Transfer Characteristics
- * High Input Impedance

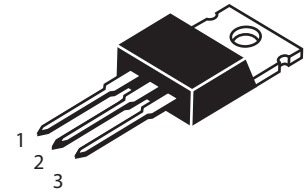

1. GATE
2. DRAIN
3. SOURCE

TO-220AB

Maximum Ratings ($T_a = 25^\circ C$ Unless Otherwise Specified)

Rating	Symbol	Value	Unit
Drain-Source Voltage	V_{DS}	200	V
Gate-Source Voltage	V_{GS}	± 20	
Continuous Drain Current, ($V_{GS}@10V, T_C=25^\circ C$) , ($V_{GS}@10V, T_C=100^\circ C$)	I_D	18 11	A
Pulsed Drain Current	I_{DM}	72	
Total Power Dissipation ($T_C=25^\circ C$)	P_D	125	W
Thermal Resistance Junction-case	$R_{\theta JC}$	1	$^\circ C/W$
Thermal Resistance Junction-ambient	$R_{\theta JA}$	62	$^\circ C/W$
Operating Junction Temperature Range	T_J	+150	$^\circ C$
Storage Temperature Range	T_{stg}	-55~+150	$^\circ C$

Electrical Characteristics (T_A = 25 °C Unless otherwise noted)

Characteristic	Symbol	Min	Typ	Max	Unit
Static					
Drain-Source Breakdown Voltage I _D =250μA, V _{GS} =0	BV _{DSS}	200	-	-	V
Gate-Source Threshold Voltage I _D =250μA, V _{DS} =V _{GS}	V _{GS(Th)}	2.0	-	4.0	
Gate-Source Leakage current V _{GS} =±20V	I _{GSS}	-	-	±100	nA
Drain-Source Leakage Current (T _j =25 °C) V _{DS} =200V, V _{GS} =0	I _{DSS}	-	-	25	μA
Drain-Source Leakage Current (T _j =125 °C) V _{DS} =160V, V _{GS} =0		-	-	250	
Static Drain-Source On-Resistance I _D =11A, V _{GS} =10V	R _{DS(on)}	-	-	0.18	Ω
Forward Transconductance I _D =11A, V _{DS} =50V	g _{fs}	6.7	-	-	S
Forward On Voltage I _S =18A, V _{GS} =0V, T _j =25 °C	V _{SD}	-	-	2.0	V

Dynamic

Input Capacitance V _{GS} =0V, V _{DS} =25V, f=1.0MHz	C _{iss}	-	1300	-	pF
Output Capacitance V _{GS} =0V, V _{DS} =25V, f=1.0MHz	C _{oss}	-	430	-	
Reverse Transfer Capacitance V _{GS} =0V, V _{DS} =25V, f=1.0MHz	C _{rss}	-	130	-	

Switching

Turn-on Delay Time I _D =18A, V _{DD} =100V, R _{GS} =9.1Ω, R _L =5.4Ω	T _{d(on)}	-	-	21	ns
Rise Time I _D =18A, V _{DD} =100V, R _{GS} =9.1Ω, R _L =5.4Ω	T _r	-	-	77	
Turn-off Delay Time I _D =18A, V _{DD} =100V, R _{GS} =9.1Ω, R _L =5.4Ω	T _{d(off)}	-	-	68	

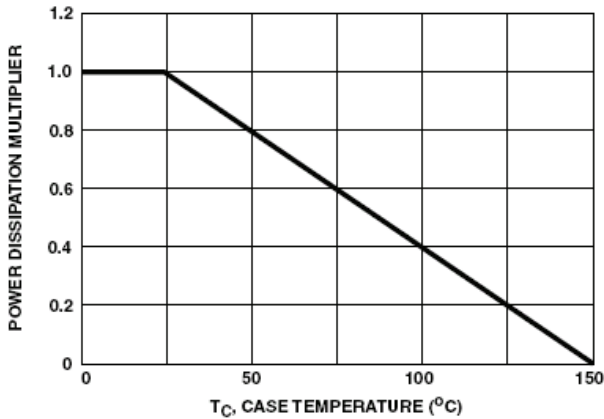

FIGURE 1. NORMALIZED POWER DISSIPATION vs CASE TEMPERATURE

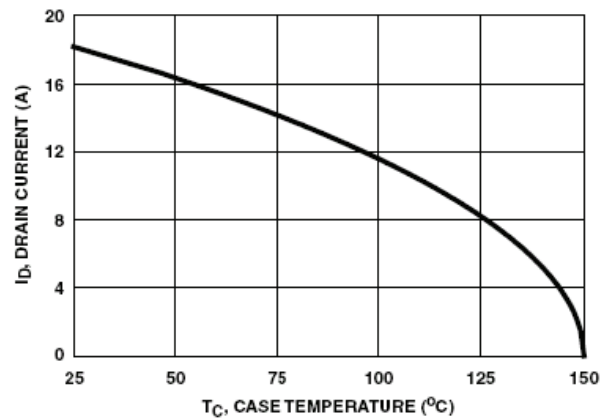

FIGURE 2. MAXIMUM CONTINUOUS DRAIN CURRENT vs CASE TEMPERATURE

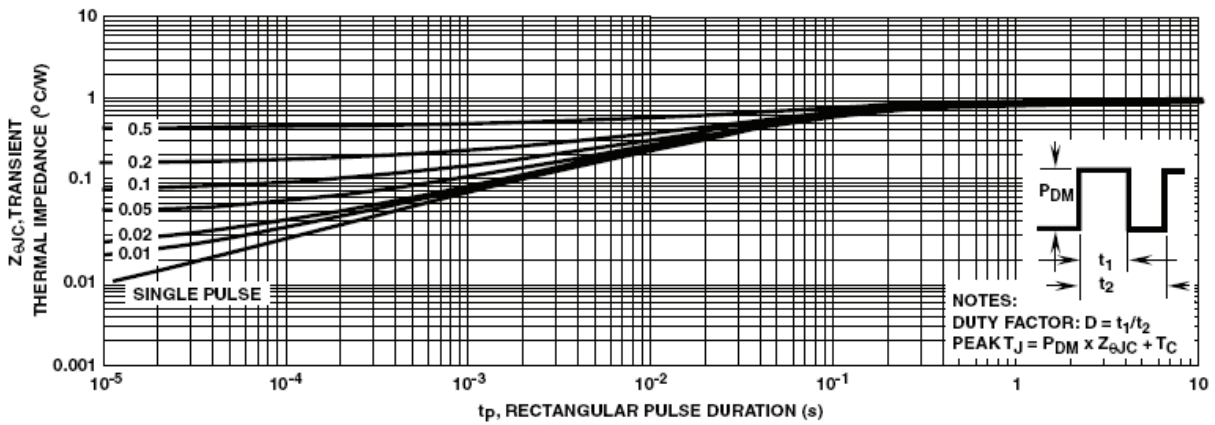

FIGURE 3. MAXIMUM TRANSIENT THERMAL IMPEDANCE

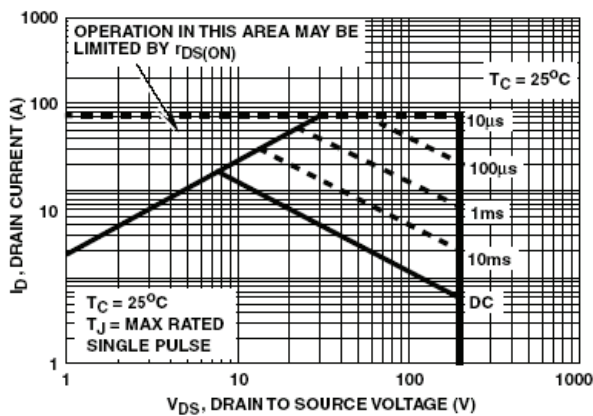

FIGURE 4. FORWARD BIAS SAFE OPERATING AREA

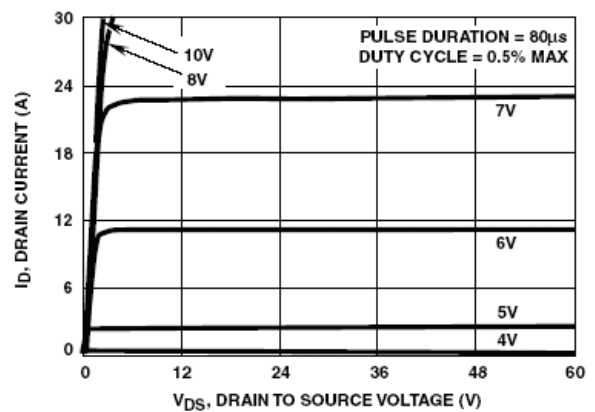

FIGURE 5. OUTPUT CHARACTERISTICS

Characteristics Curve

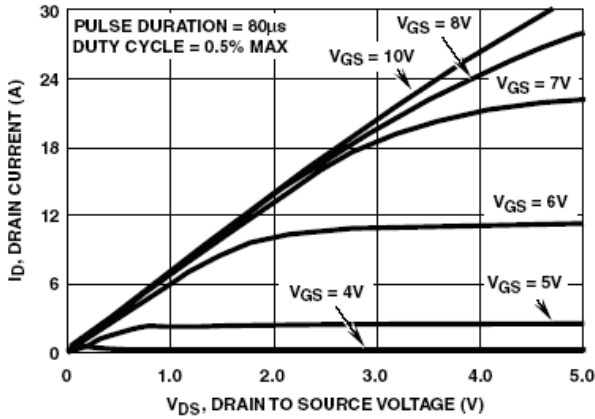

FIGURE 6. SATURATION CHARACTERISTICS

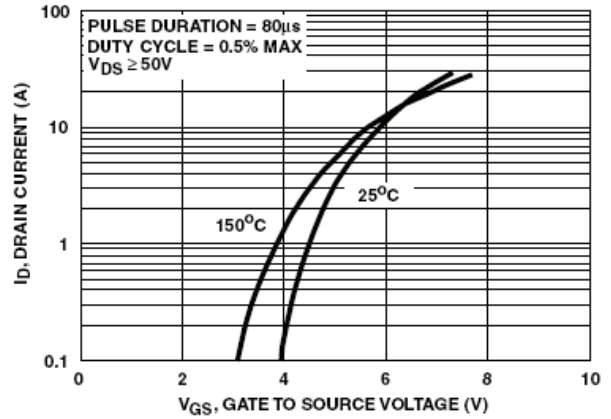

FIGURE 7. TRANSFER CHARACTERISTICS

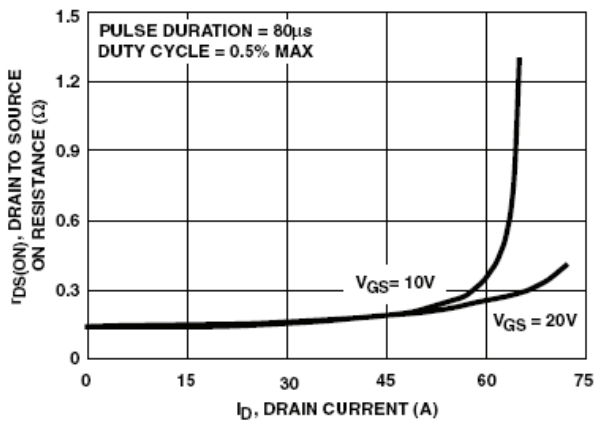

FIGURE 8. DRAIN TO SOURCE ON RESISTANCE vs GATE VOLTAGE AND DRAIN CURRENT

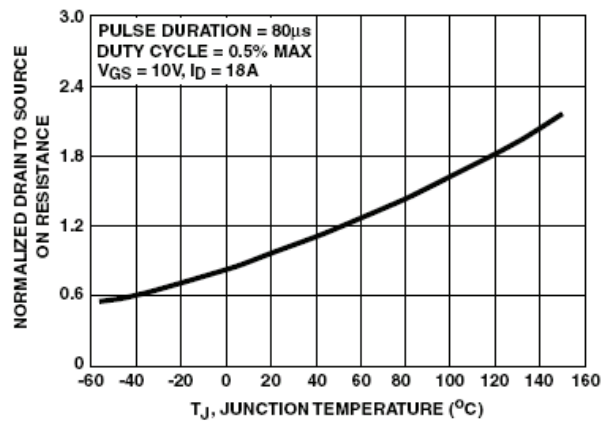

FIGURE 9. NORMALIZED DRAIN TO SOURCE ON RESISTANCE vs JUNCTION TEMPERATURE

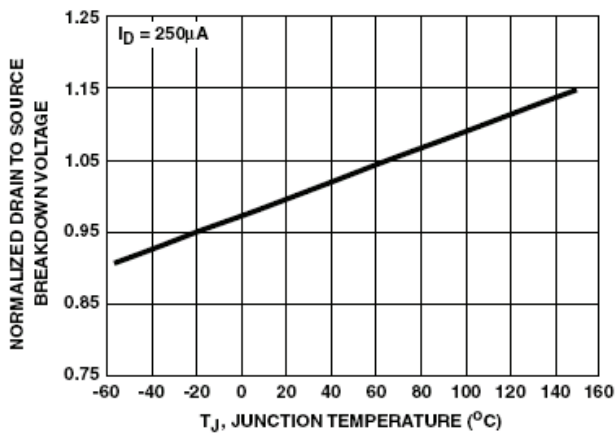

FIGURE 10. NORMALIZED DRAIN TO SOURCE BREAKDOWN VOLTAGE vs JUNCTION TEMPERATURE

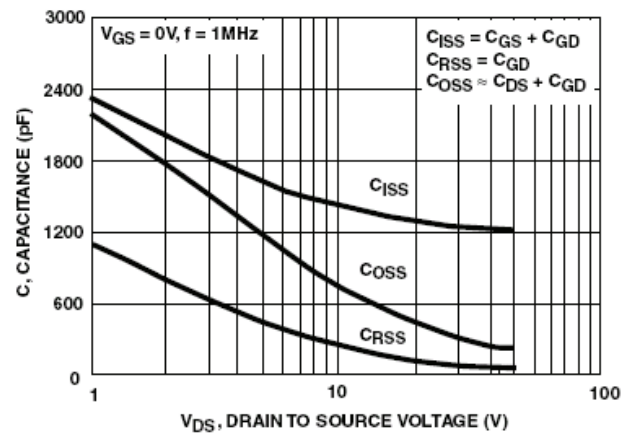

FIGURE 11. CAPACITANCE vs DRAIN TO SOURCE VOLTAGE

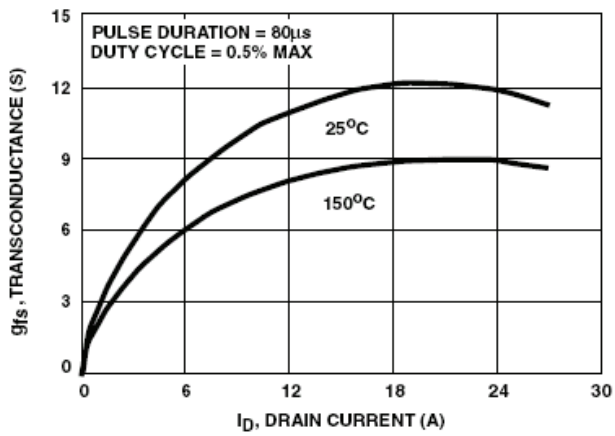

FIGURE 12. TRANSCONDUCTANCE vs DRAIN CURRENT

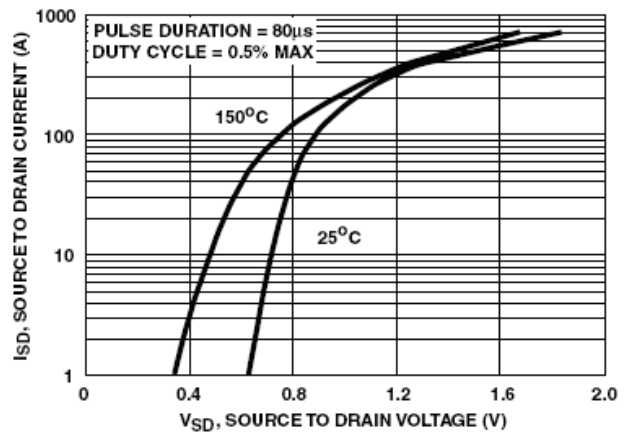

FIGURE 13. SOURCE TO DRAIN DIODE VOLTAGE

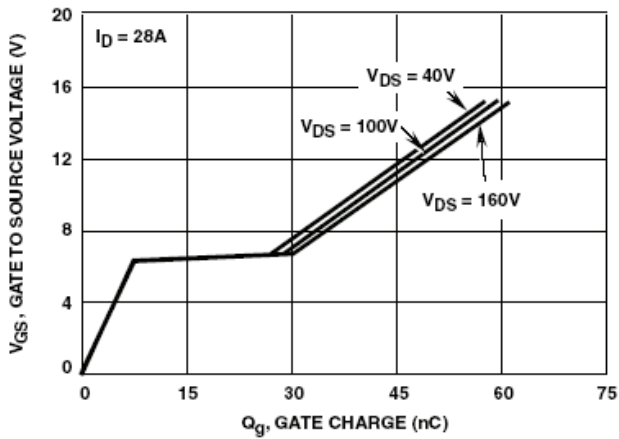
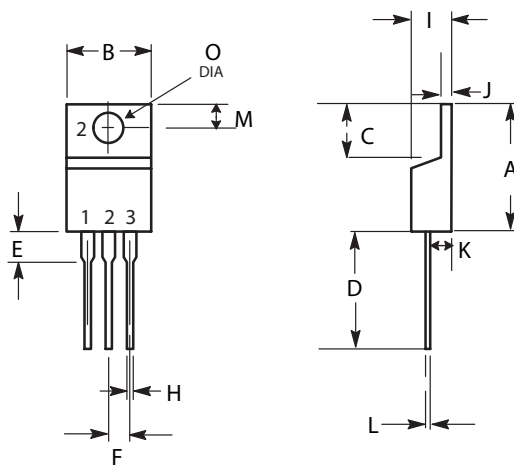

FIGURE 14. GATE TO SOURCE VOLTAGE vs GATE CHARGE

TO-220AB Outline Dimensions

Unit:mm



TO-220AB		
Dim	Min	Max
A	14.68	15.32
B	9.78	10.42
C	5.02	6.52
D	13.06	14.62
E	3.57	4.07
F	2.42	2.66
H	0.72	0.96
I	4.22	4.98
J	1.14	1.36
K	2.20	2.97
L	0.33	0.55
M	2.48	2.98
O	3.70	3.90