

HEXFET® Power MOSFET

	N-CH	P-CH	
V_{DS}	25	-25	V
$R_{DS(on) \text{ max}}$ (@ $V_{GS} = 10V$)	0.1	0.25	Ω
Q_g (typical)	9.4	10	nC
I_D (@ $T_A = 25^\circ C$)	3.5	-2.3	A

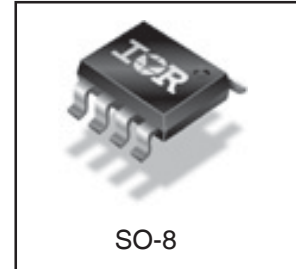
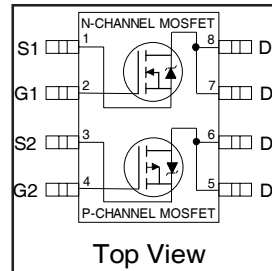

Features

Industry-standard pinout SO-8 Package
Compatible with Existing Surface Mount Techniques
RoHS Compliant, Halogen-Free
MSL1, Industrial qualification

⇒

Benefits

Multi-Vendor Compatibility
Easier Manufacturing
Environmentally Friendlier
Increased Reliability

Base Part Number	Package Type	Standard Pack		Orderable Part Number
		Form	Quantity	
IRF7105PbF-1	SO-8	Tape and Reel	4000	IRF7105TRPbF-1

Absolute Maximum Ratings

	Parameter	Max.		Units
		N-Channel	P-Channel	
$I_D @ T_A = 25^\circ C$	Continuous Drain Current, $V_{GS} @ 10V$	3.5	-2.3	A
$I_D @ T_A = 70^\circ C$	Continuous Drain Current, $V_{GS} @ 10V$	2.8	-1.8	
I_{DM}	Pulsed Drain Current ①	14	-10	
$P_D @ T_C = 25^\circ C$	Power Dissipation	2.0		W
	Linear Derating Factor	0.016		W/°C
V_{GS}	Gate-to-Source Voltage	± 20		V
dv/dt	Peak Diode Recovery dv/dt ②	3.0	-3.0	V/nS
T_J, T_{STG}	Junction and Storage Temperature Range	-55 to + 150		°C

Thermal Resistance Ratings

	Parameter	Min.	Typ.	Max.	Units
$R_{\theta JA}$	Maximum Junction-to-Ambient ④	—	—	62.5	°C/W



Electrical Characteristics @ T_J = 25°C (unless otherwise specified)

Parameter	Description	Type	Min.	Typ.	Max.	Units	Conditions
V _{(BR)DSS}	Drain-to-Source Breakdown Voltage	N-Ch	25	—	—	V	V _{GS} = 0V, I _D = 250μA
		P-Ch	-25	—	—		V _{GS} = 0V, I _D = -250μA
ΔV _{(BR)DSS} /ΔT _J	Breakdown Voltage Temp. Coefficient	N-Ch	—	0.030	—	V/°C	Reference to 25°C, I _D = 1mA
		P-Ch	—	-0.015	—		Reference to 25°C, I _D = -1mA
R _{DS(ON)}	Static Drain-to-Source On-Resistance	N-Ch	—	0.083	0.10	Ω	V _{GS} = 10V, I _D = 1.0A ③
			—	0.14	0.16		V _{GS} = 4.5V, I _D = 0.50A ③
		P-Ch	—	0.16	0.25		V _{GS} = -10V, I _D = -1.0A ③
			—	0.30	0.40		V _{GS} = -4.5V, I _D = -0.50A ③
V _{GS(th)}	Gate Threshold Voltage	N-Ch	1.0	—	3.0	V	V _{DS} = V _{GS} , I _D = 250μA
		P-Ch	-1.0	—	-3.0		V _{DS} = V _{GS} , I _D = -250μA
g _{fs}	Forward Transconductance	N-Ch	—	4.3	—	S	V _{DS} = 15V, I _D = 3.5A ③
		P-Ch	—	3.1	—		V _{DS} = -15V, I _D = -3.5A ③
I _{DSS}	Drain-to-Source Leakage Current	N-Ch	—	—	2.0	μA	V _{DS} = 20V, V _{GS} = 0V
		P-Ch	—	—	-2.0		V _{DS} = -20V, V _{GS} = 0V
		N-Ch	—	—	25		V _{DS} = 20V, V _{GS} = 0V, T _J = 55°C
		P-Ch	—	—	-25		V _{DS} = -20V, V _{GS} = 0V, T _J = 55°C
I _{GSS}	Gate-to-Source Forward Leakage	N-P	—	—	±100	V _{GS} = ±20V	
Q _g	Total Gate Charge	N-Ch	—	9.4	27	nC	N-Channel I _D = 2.3A, V _{DS} = 12.5V, V _{GS} = 10V ③
		P-Ch	—	10	25		
Q _{gs}	Gate-to-Source Charge	N-Ch	—	1.7	—	nC	P-Channel I _D = -2.3A, V _{DS} = -12.5V, V _{GS} = -10V ③
		P-Ch	—	1.9	—		
Q _{gd}	Gate-to-Drain ("Miller") Charge	N-Ch	—	3.1	—	nC	P-Channel I _D = -2.3A, V _{DS} = -12.5V, V _{GS} = -10V ③
		P-Ch	—	2.8	—		
t _{d(on)}	Turn-On Delay Time	N-Ch	—	7.0	20	ns	N-Channel V _{DD} = 25V, I _D = 1.0A, R _G = 6.0Ω, R _D = 25Ω ③
t _r	Rise Time	N-Ch	—	9.0	20		
		P-Ch	—	13	40		
t _{d(off)}	Turn-Off Delay Time	N-Ch	—	45	90	ns	P-Channel V _{DD} = -25V, I _D = -1.0A, R _G = 6.0Ω, R _D = 25Ω ③
		P-Ch	—	45	90		
t _f	Fall Time		N-Ch	—	25		
L _D	Internal Drain Inductance	N-P	—	4.0	—	nH	Between lead, 6mm (0.25in.) from package and center of die contact
L _S	Internal Source Inductance	N-P	—	6.0	—		
C _{iss}	Input Capacitance	N-Ch	—	330	—	pF	N-Channel V _{GS} = 0V, V _{DS} = 15V, f = 1.0MHz
		P-Ch	—	290	—		
C _{oss}	Output Capacitance	N-Ch	—	250	—		
		P-Ch	—	210	—		
C _{rss}	Reverse Transfer Capacitance	N-Ch	—	61	—	pF	P-Channel V _{GS} = 0V, V _{DS} = -15V, f = 1.0MHz
		P-Ch	—	67	—		

Source-Drain Ratings and Characteristics

Parameter	Description	Type	Min.	Typ.	Max.	Units	Conditions
I _S	Continuous Source Current (Body Diode)	N-Ch	—	—	2.0	A	
		P-Ch	—	—	-2.0		
I _{SM}	Pulsed Source Current (Body Diode) ①	N-Ch	—	—	14	A	
		P-Ch	—	—	-9.2		
V _{SD}	Diode Forward Voltage	N-Ch	—	—	1.2	V	T _J = 25°C, I _S = 1.3A, V _{GS} = 0V ③
		P-Ch	—	—	-1.2		T _J = 25°C, I _S = -1.3A, V _{GS} = 0V ③
t _{rr}	Reverse Recovery Time	N-Ch	—	36	54	ns	N-Channel T _J = 25°C, I _F = 1.3A, di/dt = 100A/μs ③
		P-Ch	—	69	100		
Q _{rr}	Reverse Recovery Charge	N-Ch	—	41	75	nC	P-Channel T _J = 25°C, I _F = -1.3A, di/dt = 100A/μs ③
		P-Ch	—	90	180		
t _{on}	Forward Turn-On Time	N-P	Intrinsic turn-on time is negligible (turn-on is dominated by L _S +L _D)				

Notes:

- ① Repetitive rating; pulse width limited by max. junction temperature.
- ② N-Channel I_{SD} ≤ 3.5A, di/dt ≤ 90A/μs, V_{DD} ≤ V_{(BR)DSS}, T_J ≤ 150°C
P-Channel I_{SD} ≤ -2.3A, di/dt ≤ 90A/μs, V_{DD} ≤ V_{(BR)DSS}, T_J ≤ 150°C
- ③ Pulse width ≤ 300μs; duty cycle ≤ 2%.
- ④ Surface mounted on FR-4 board, t ≤ 10sec.

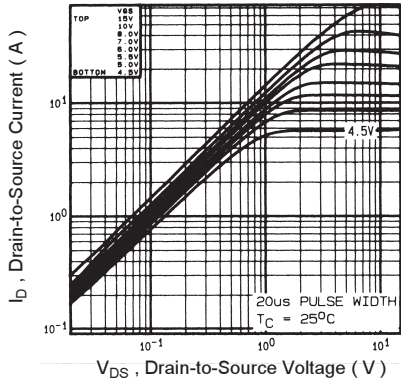
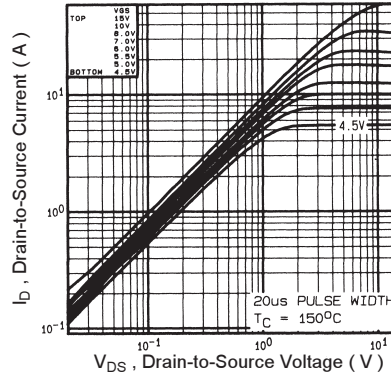
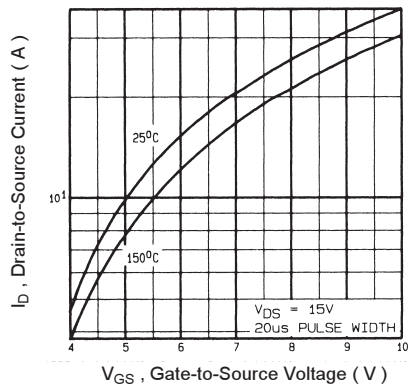
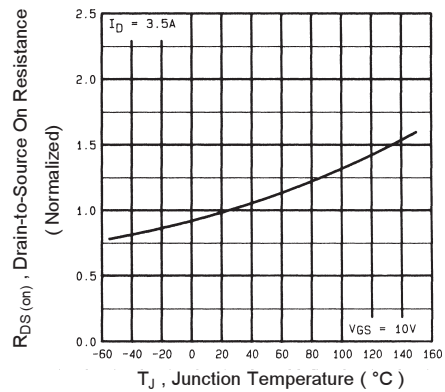
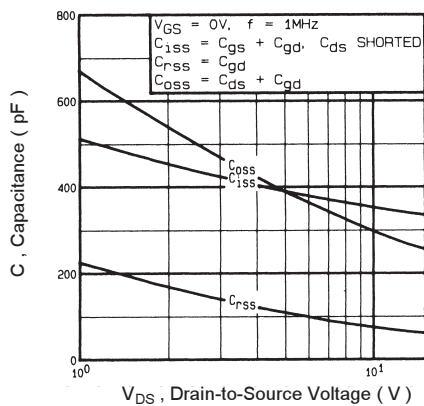
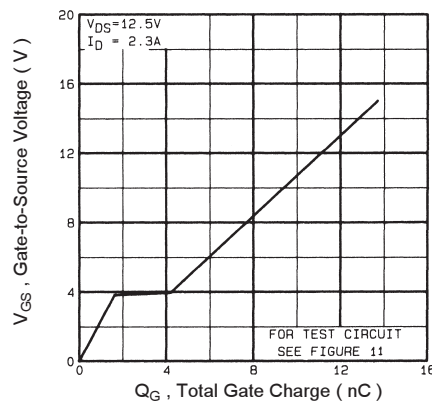
N-Channel

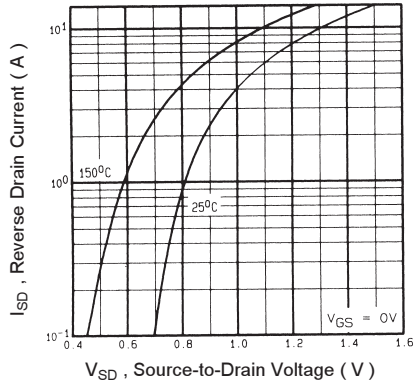
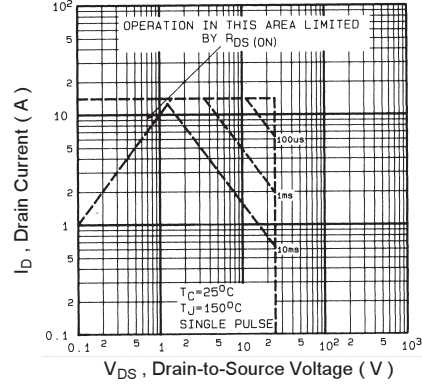
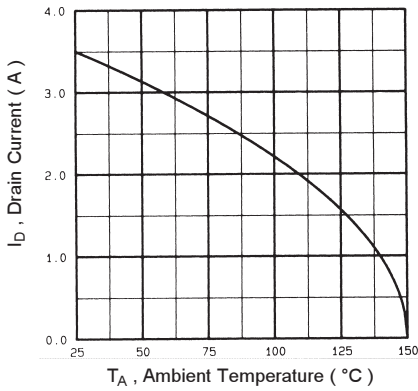
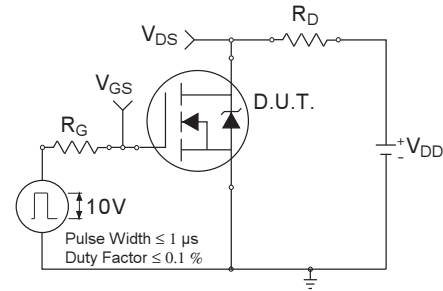
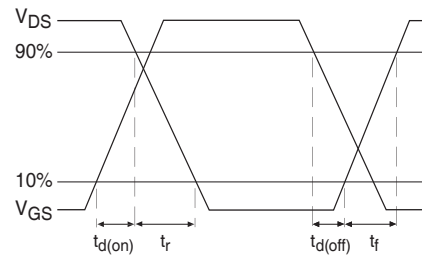
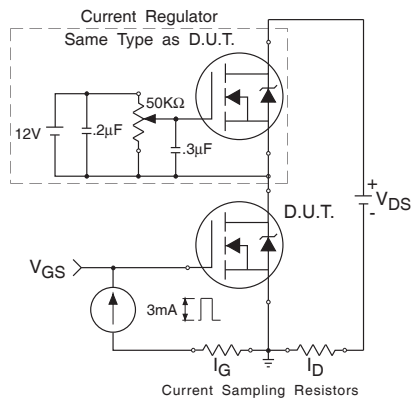
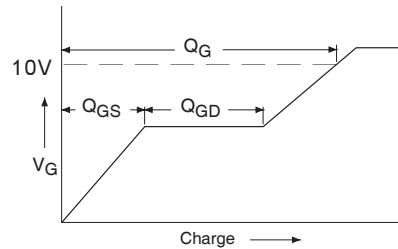
Fig 1. Typical Output Characteristics

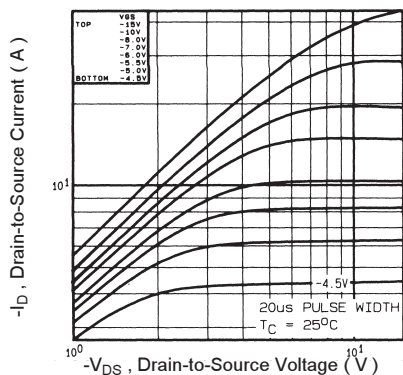
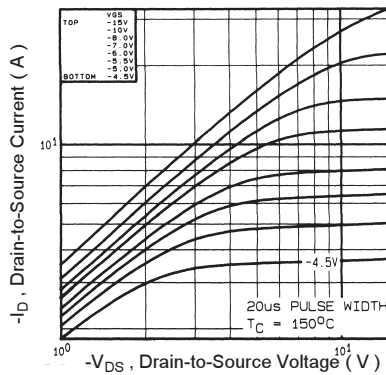
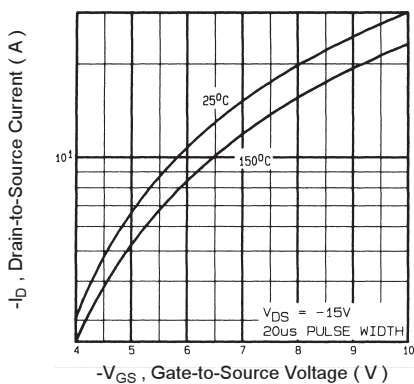
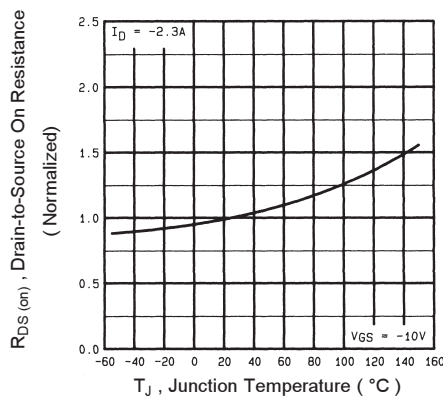
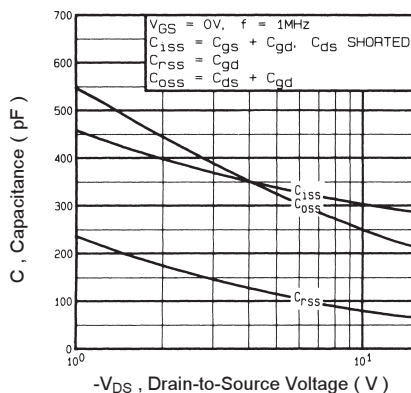
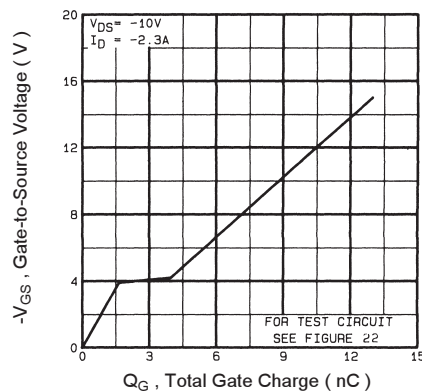
Fig 2. Typical Output Characteristics

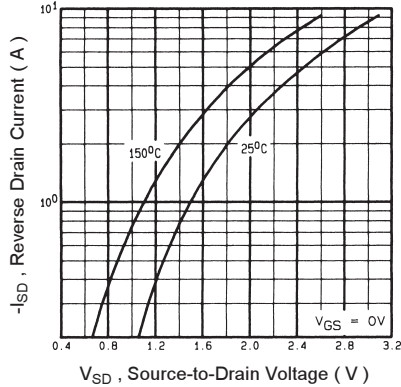
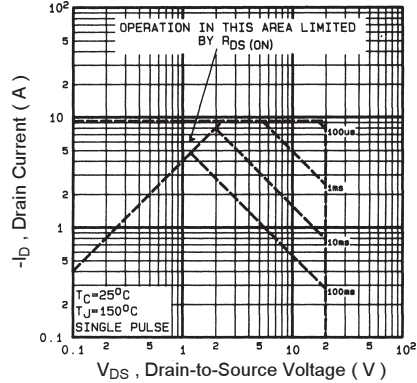
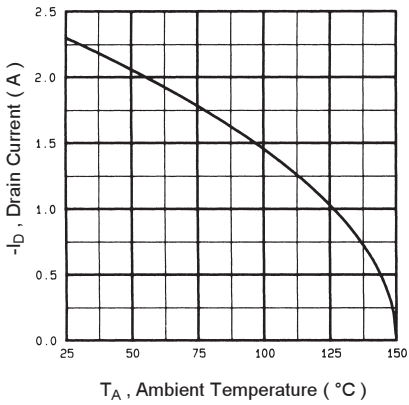
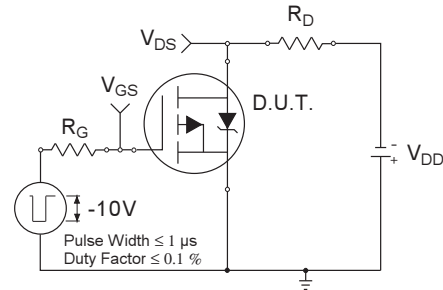
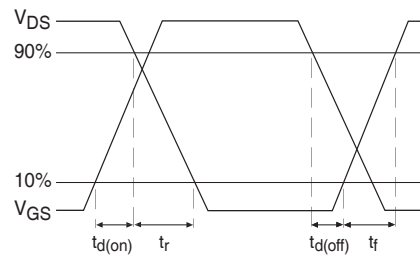
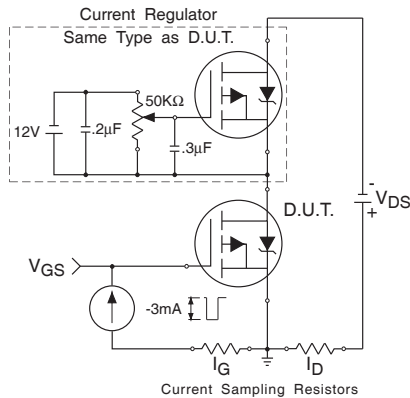
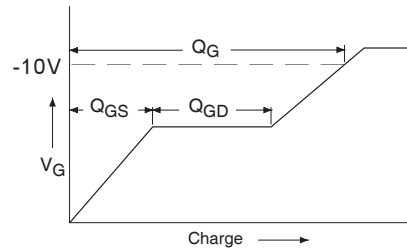
Fig 3. Typical Transfer Characteristics

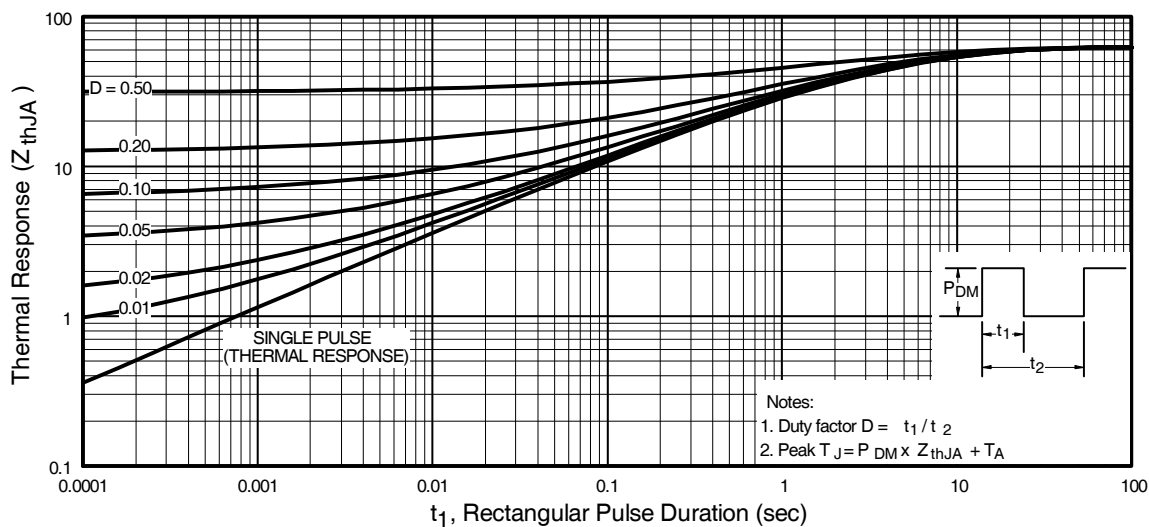
Fig 4. Normalized On-Resistance Vs. Temperature

Fig 5. Typical Capacitance Vs. Drain-to-Source Voltage

Fig 6. Typical Gate Charge Vs. Gate-to-Source Voltage

N-Channel

Fig 7. Typical Source-Drain Diode Forward Voltage

Fig 8. Maximum Safe Operating Area

Fig 9. Maximum Drain Current Vs. Ambient Temperature

Fig 10a. Switching Time Test Circuit

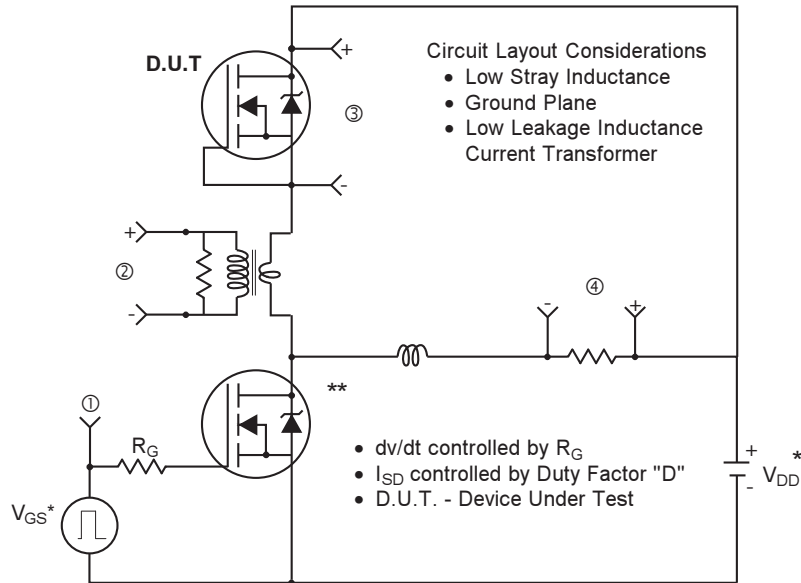
Fig 10b. Switching Time Waveforms

Fig 11a. Gate Charge Test Circuit

Fig 11b. Basic Gate Charge Waveform

P-Channel

Fig 12. Typical Output Characteristics

Fig 13. Typical Output Characteristics

Fig 14. Typical Transfer Characteristics

Fig 15. Normalized On-Resistance Vs. Temperature

Fig 16. Typical Capacitance Vs. Drain-to-Source Voltage

Fig 17. Typical Gate Charge Vs. Gate-to-Source Voltage

P-Channel

Fig 18. Typical Source-Drain Diode Forward Voltage

Fig 19. Maximum Safe Operating Area

Fig 20. Maximum Drain Current Vs. Ambient Temperature

Fig 21a. Switching Time Test Circuit

Fig 21b. Switching Time Waveforms

Fig 22a. Gate Charge Test Circuit

Fig 22b. Basic Gate Charge Waveform

N & P-Channel

Fig 23. Maximum Effective Transient Thermal Impedance, Junction-to-Ambient

Peak Diode Recovery dv/dt Test Circuit

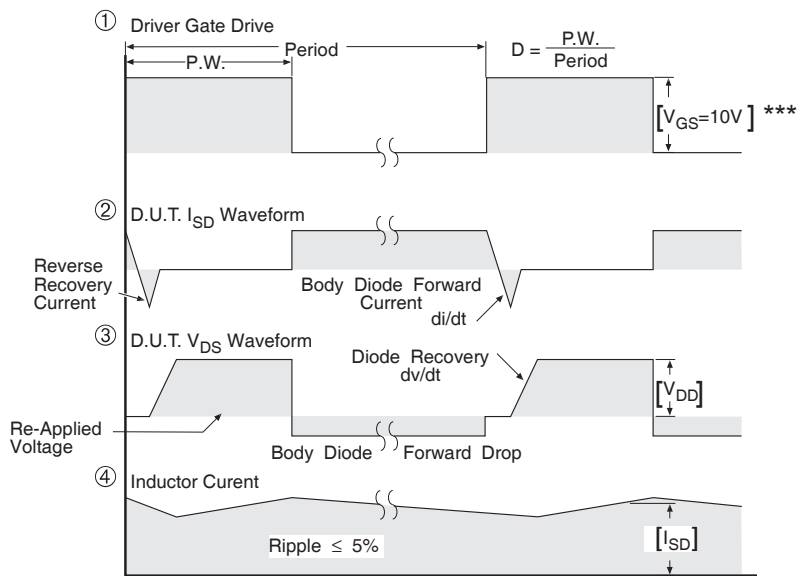

* Reverse Polarity for P-Channel

** Use P-Channel Driver for P-Channel Measurements



*** $V_{GS} = 5.0V$ for Logic Level and 3V Drive Devices

Fig 24. For N and P Channel HEXFETS



SO-8 Package Outline

Dimensions are shown in millimeters (inches)

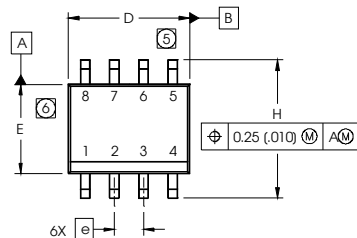

DIM	INCHES		MILLIMETERS	
	MIN	MAX	MIN	MAX
A	.0532	.0688	1.35	1.75
A1	.0040	.0098	0.10	0.25
b	.013	.020	0.33	0.51
c	.0075	.0098	0.19	0.25
D	.189	.1968	4.80	5.00
E	.1497	.1574	3.80	4.00
e	.050 BASIC		1.27 BASIC	
e1	.025 BASIC		0.635 BASIC	
H	.2284	.2440	5.80	6.20
K	.0099	.0196	0.25	0.50
L	.016	.050	0.40	1.27
y	0°	8°	0°	8°

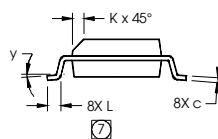
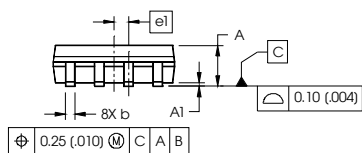

NOTES:

1. DIMENSIONING & TOLERANCING PER ASME Y14.5M-1994.
2. CONTROLLING DIMENSION: MILLIMETER
3. DIMENSIONS ARE SHOWN IN MILLIMETERS (INCHES).
4. OUTLINE CONFORMS TO JEDEC OUTLINE MS-012AA.
5. DIMENSION DOES NOT INCLUDE MOLD PROTRUSIONS. MOLD PROTRUSIONS NOT TO EXCEED 0.15 (.006).
6. DIMENSION DOES NOT INCLUDE MOLD PROTRUSIONS. MOLD PROTRUSIONS NOT TO EXCEED 0.25 (.010).
7. DIMENSION IS THE LENGTH OF LEAD FOR SOLDERING TO A SUBSTRATE.

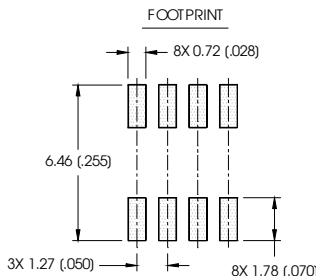

SO-8 Part Marking Information (Lead-Free)

EXAMPLE: THIS IS AN IRF7101 (MOSFET)

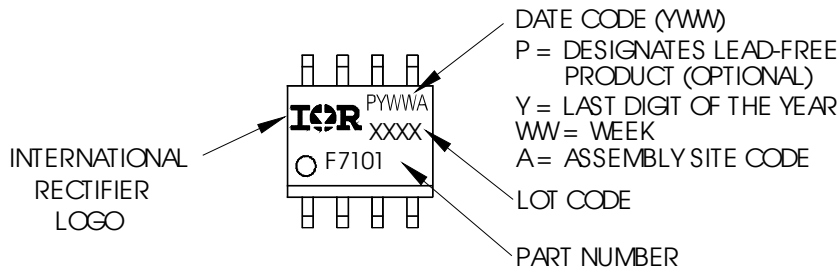

Note: For the most current drawing please refer to IR website at: <http://www.irf.com/package/>

SO-8 Tape and Reel (Dimensions are shown in millimeters (inches))

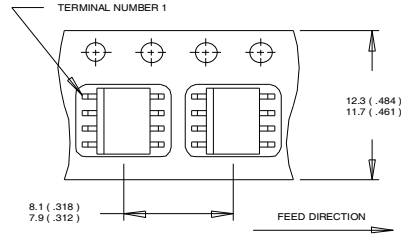

NOTES:
 1. CONTROLLING DIMENSION : MILLIMETER.
 2. ALL DIMENSIONS ARE SHOWN IN MILLIMETERS(INCHES).
 3. OUTLINE CONFORMS TO EIA-481 & EIA-541.

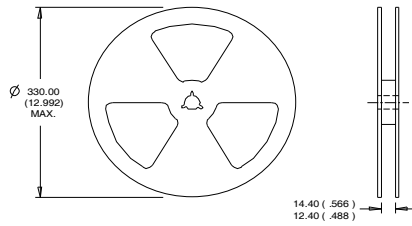

NOTES:
 1. CONTROLLING DIMENSION : MILLIMETER.
 2. OUTLINE CONFORMS TO EIA-481 & EIA-541.

Note: For the most current drawing please refer to IR website at: <http://www.irf.com/package/>

Qualification information[†]

Qualification level	Industrial (per JEDEC JESD47F ^{††} guidelines)	
Moisture Sensitivity Level	SO-8	MSL1 (per JEDEC J-STD-020D ^{††})
RoHS compliant	Yes	

[†] Qualification standards can be found at International Rectifier's web site: <http://www.irf.com/product-info/reliability>

^{††} Applicable version of JEDEC standard at the time of product release

Revision History

Date	Comments
10/16/2014	<ul style="list-style-type: none"> Corrected part number from "IRF7105PbF-1" to "IRF7105TRPbF-1" -all pages Removed the "IRF7105PbF-1" bulk part number from ordering information on page1