

IRF7317PbF

HEXFET® Power MOSFET

- Generation V Technology
- Ultra Low On-Resistance
- Dual N and P Channel MOSFET
- Surface Mount
- Fully Avalanche Rated
- Lead-Free

Description

Fifth Generation HEXFETs from International Rectifier utilize advanced processing techniques to achieve extremely low on-resistance per silicon area. This benefit, combined with the fast switching speed and ruggedized device design that HEXFET Power MOSFETs are well known for, provides the designer with an extremely efficient and reliable device for use in a wide variety of applications.

The SO-8 has been modified through a customized leadframe for enhanced thermal characteristics and multiple-die capability making it ideal in a variety of power applications. With these improvements, multiple devices can be used in an application with dramatically reduced board space. The package is designed for vapor phase, infra red, or wave soldering techniques.

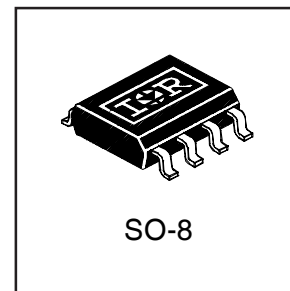
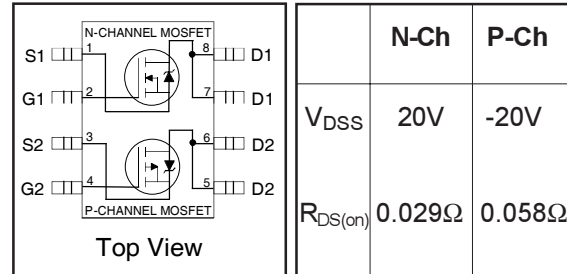

Absolute Maximum Ratings ($T_A = 25^\circ\text{C}$ Unless Otherwise Noted)

	Symbol	Maximum		Units
		N-Channel	P-Channel	
Drain-Source Voltage	V_{DS}	20	-20	
Gate-Source Voltage	V_{GS}	± 12		
Continuous Drain Current ^①	$T_A = 25^\circ\text{C}$ $T_A = 70^\circ\text{C}$	6.6	-5.3	A
		5.3	-4.3	
Pulsed Drain Current	I_{DM}	26	-21	
Continuous Source Current (Diode Conduction)	I_S	2.5	-2.5	
Maximum Power Dissipation ^②	$T_A = 25^\circ\text{C}$ $T_A = 70^\circ\text{C}$	2.0		W
		1.3		
Single Pulse Avalanche Energy	E_{AS}	100	150	mJ
Avalanche Current	I_{AR}	4.1	-2.9	A
Repetitive Avalanche Energy	E_{AR}	0.20		mJ
Peak Diode Recovery dv/dt ^③	dv/dt	5.0	-5.0	V/ ns
Junction and Storage Temperature Range	T_J, T_{STG}	-55 to + 150 °C		

Thermal Resistance Ratings

Parameter	Symbol	Limit	Units
Maximum Junction-to-Ambient ^④	$R_{\theta JA}$	62.5	$^\circ\text{C/W}$

IRF7317PbF

International
IR Rectifier

Electrical Characteristics @ T_J = 25°C (unless otherwise specified)

Parameter	Description		Min.	Typ.	Max.	Units	Conditions
V _{(BR)DSS}	Drain-to-Source Breakdown Voltage	N-Ch	20	—	—	V	V _{GS} = 0V, I _D = 250μA
		P-Ch	-20	—	—		V _{GS} = 0V, I _D = -250μA
ΔV _{(BR)DSS} /ΔT _J	Breakdown Voltage Temp. Coefficient	N-Ch	—	0.027	—	V/°C	Reference to 25°C, I _D = 1mA
		P-Ch	—	0.031	—		Reference to 25°C, I _D = -1mA
R _{DS(ON)}	Static Drain-to-Source On-Resistance	N-Ch	—	0.023	0.029	Ω	V _{GS} = 4.5V, I _D = 6.0A ④
			—	0.030	0.046		V _{GS} = 2.7V, I _D = 5.2A ④
		P-Ch	—	0.049	0.058		V _{GS} = -4.5V, I _D = -2.9A ④
			—	0.082	0.098		V _{GS} = -2.7V, I _D = -1.5A ④
V _{GS(th)}	Gate Threshold Voltage	N-Ch	0.7	—	—	V	V _{DS} = V _{GS} , I _D = 250μA
		P-Ch	-0.7	—	—		V _{DS} = V _{GS} , I _D = -250μA
g _{fs}	Forward Transconductance	N-Ch	—	20	—	S	V _{DS} = 10V, I _D = 6.0A ④
		P-Ch	—	5.9	—		V _{DS} = -10V, I _D = -1.5A ④
I _{DSS}	Drain-to-Source Leakage Current	N-Ch	—	—	1.0	μA	V _{DS} = 16V, V _{GS} = 0V
		P-Ch	—	—	-1.0		V _{DS} = -16V, V _{GS} = 0V
		N-Ch	—	—	5.0		V _{DS} = 16V, V _{GS} = 0V, T _J = 55°C
		P-Ch	—	—	-25		V _{DS} = -16V, V _{GS} = 0V, T _J = 55°C
I _{GSS}	Gate-to-Source Forward Leakage	N-P	—	—	±100	nA	V _{GS} = ±12V
Q _g	Total Gate Charge	N-Ch	—	18	27	nC	N-Channel I _D = 6.0A, V _{DS} = 10V, V _{GS} = 4.5V ④
		P-Ch	—	19	29		
Q _{gs}	Gate-to-Source Charge	N-Ch	—	2.2	3.3	nC	
		P-Ch	—	4.0	6.1		
Q _{gd}	Gate-to-Drain ("Miller") Charge	N-Ch	—	6.2	9.3	nC	P-Channel I _D = -2.9A, V _{DS} = -16V, V _{GS} = -4.5V
		P-Ch	—	7.7	12		
t _{d(on)}	Turn-On Delay Time	N-Ch	—	8.1	12	ns	N-Channel V _{DD} = 10V, I _D = 1.0A, R _G = 6.0Ω, R _D = 10Ω ④
		P-Ch	—	15	22		
t _r	Rise Time	N-Ch	—	17	25	ns	
		P-Ch	—	40	60		
t _{d(off)}	Turn-Off Delay Time	N-Ch	—	38	57	ns	P-Channel V _{DD} = -10V, I _D = -2.9A, R _G = 6.0Ω, R _D = 3.4Ω ④
		P-Ch	—	42	63		
t _f	Fall Time	N-Ch	—	31	47	ns	
		P-Ch	—	49	73		
C _{iss}	Input Capacitance	N-Ch	—	900	—	pF	N-Channel V _{GS} = 0V, V _{DS} = 15V, f = 1.0MHz
		P-Ch	—	780	—		
C _{oss}	Output Capacitance	N-Ch	—	430	—	pF	P-Channel V _{GS} = 0V, V _{DS} = -15V, f = 1.0MHz
		P-Ch	—	470	—		
C _{rss}	Reverse Transfer Capacitance	N-Ch	—	200	—	pF	
		P-Ch	—	240	—		

Source-Drain Ratings and Characteristics

Parameter	Description		Min.	Typ.	Max.	Units	Conditions
I _S	Continuous Source Current (Body Diode)	N-Ch	—	—	2.5	A	
		P-Ch	—	—	-2.5		
I _{SM}	Pulsed Source Current (Body Diode) ①	N-Ch	—	—	26	A	
		P-Ch	—	—	-21		
V _{SD}	Diode Forward Voltage	N-Ch	—	0.72	1.0	V	T _J = 25°C, I _S = 1.7A, V _{GS} = 0V ③
		P-Ch	—	-0.78	-1.0		T _J = 25°C, I _S = -2.9A, V _{GS} = 0V ③
t _{rr}	Reverse Recovery Time	N-Ch	—	52	77	ns	N-Channel T _J = 25°C, I _F = 1.7A, di/dt = 100A/μs ④
		P-Ch	—	47	71		
Q _{rr}	Reverse Recovery Charge	N-Ch	—	58	86	nC	P-Channel T _J = 25°C, I _F = -2.9A, di/dt = 100A/μs ④
		P-Ch	—	49	73		

Notes:

- ① Repetitive rating; pulse width limited by max. junction temperature. (See fig. 22)
- ② N-Channel I_{SD} ≤ 4.1A, di/dt ≤ 92A/μs, V_{DD} ≤ V_{(BR)DSS}, T_J ≤ 150°C
 P-Channel I_{SD} ≤ -2.9A, di/dt ≤ -77A/μs, V_{DD} ≤ V_{(BR)DSS}, T_J ≤ 150°C
- ③ N-Channel Starting T_J = 25°C, L = 12mH R_G = 25Ω, I_{AS} = 4.1A. (See Figure 12)
 P-Channel Starting T_J = 25°C, L = 35mH R_G = 25Ω, I_{AS} = -2.9A.
- ④ Pulse width ≤ 300μs; duty cycle ≤ 2%.
- ⑤ Surface mounted on FR-4 board, t ≤ 10sec.

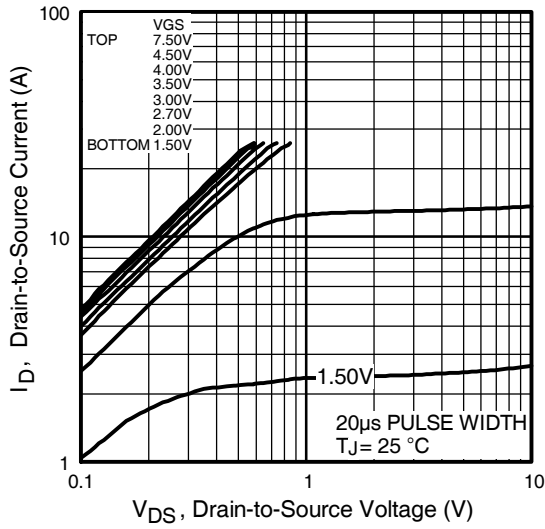

Fig 1. Typical Output Characteristics

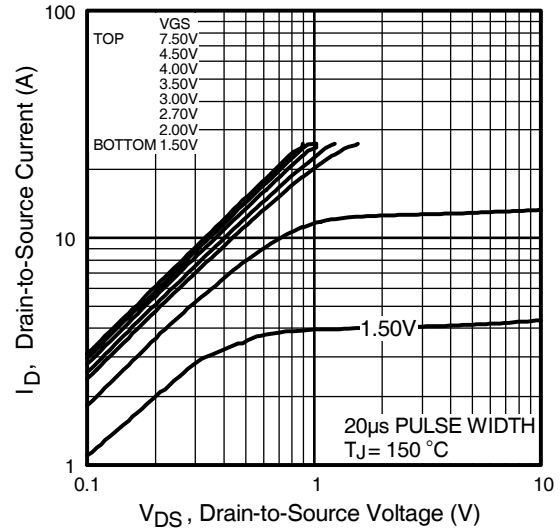

Fig 2. Typical Output Characteristics

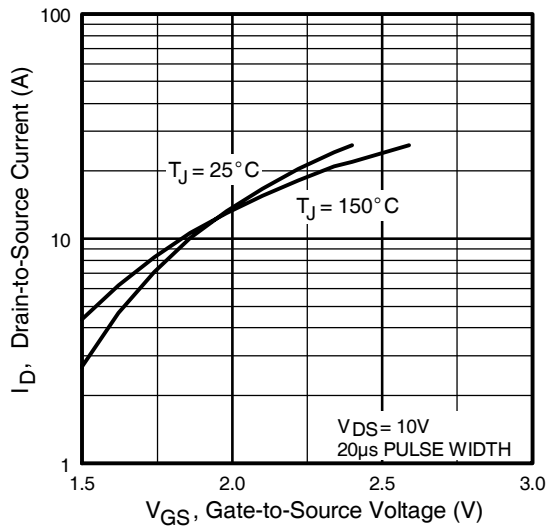

Fig 3. Typical Transfer Characteristics

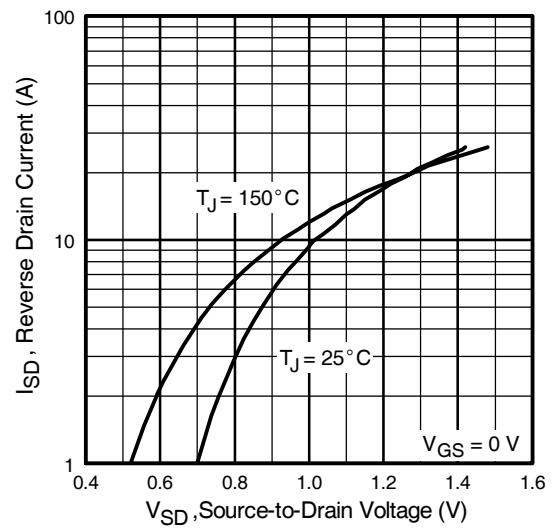

Fig 4. Typical Source-Drain Diode Forward Voltage

IRF7317PbF

N-Channel

International
IR Rectifier

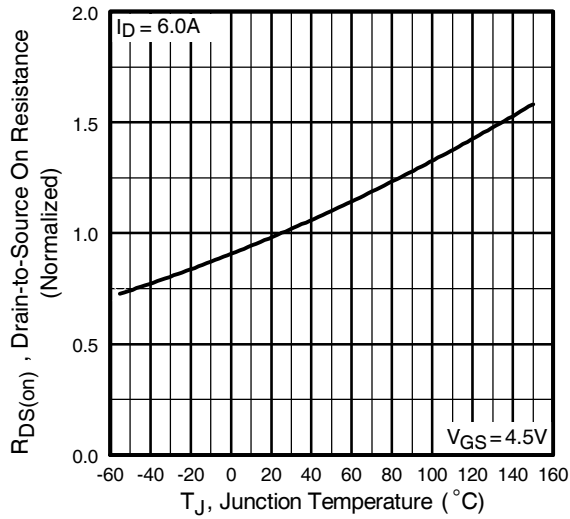

Fig 5. Normalized On-Resistance Vs. Temperature

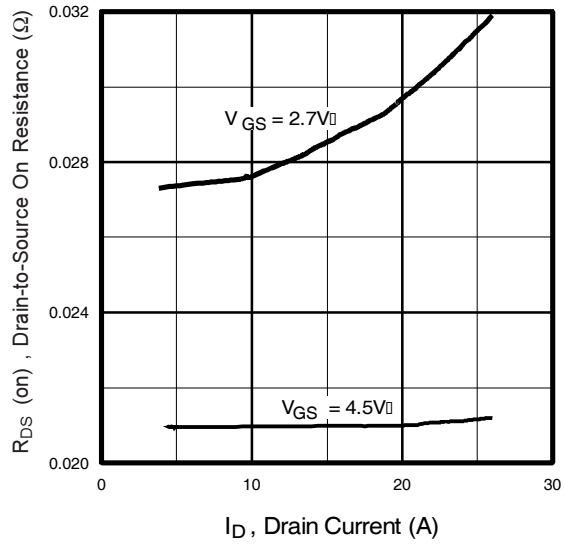

Fig 6. Typical On-Resistance Vs. Drain Current

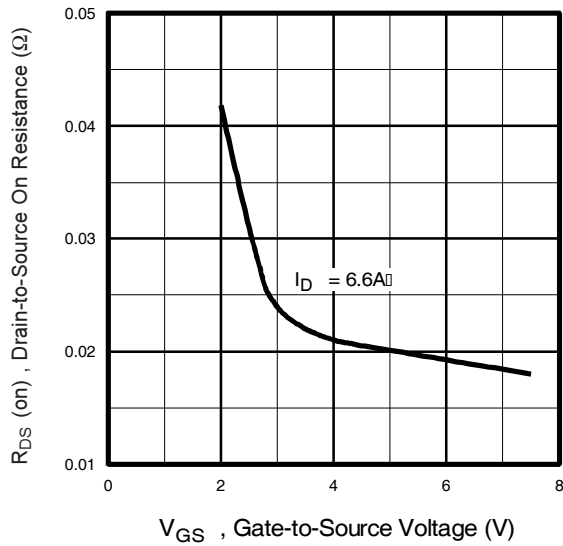

Fig 7. Typical On-Resistance Vs. Gate Voltage

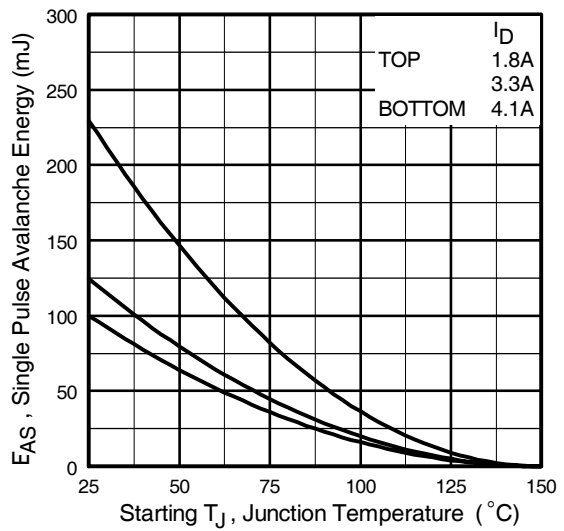

Fig 8. Maximum Avalanche Energy Vs. Drain Current

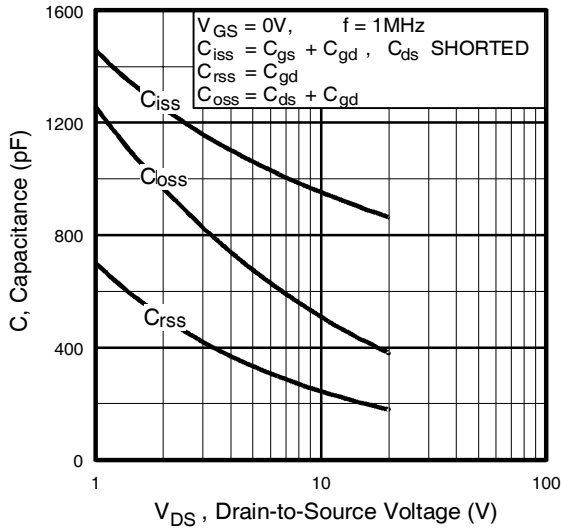

Fig 9. Typical Capacitance Vs. Drain-to-Source Voltage

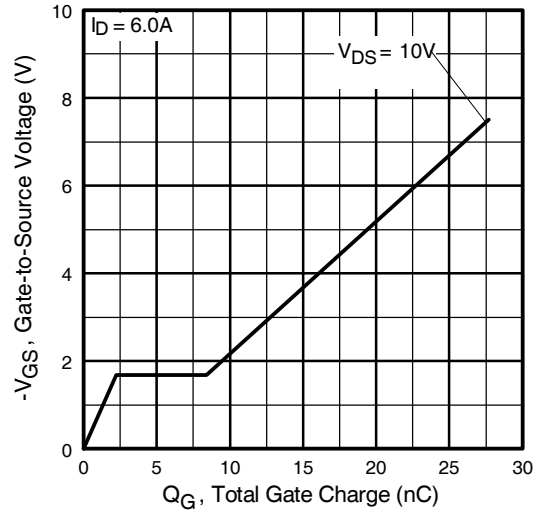

Fig 10. Typical Gate Charge Vs. Gate-to-Source Voltage

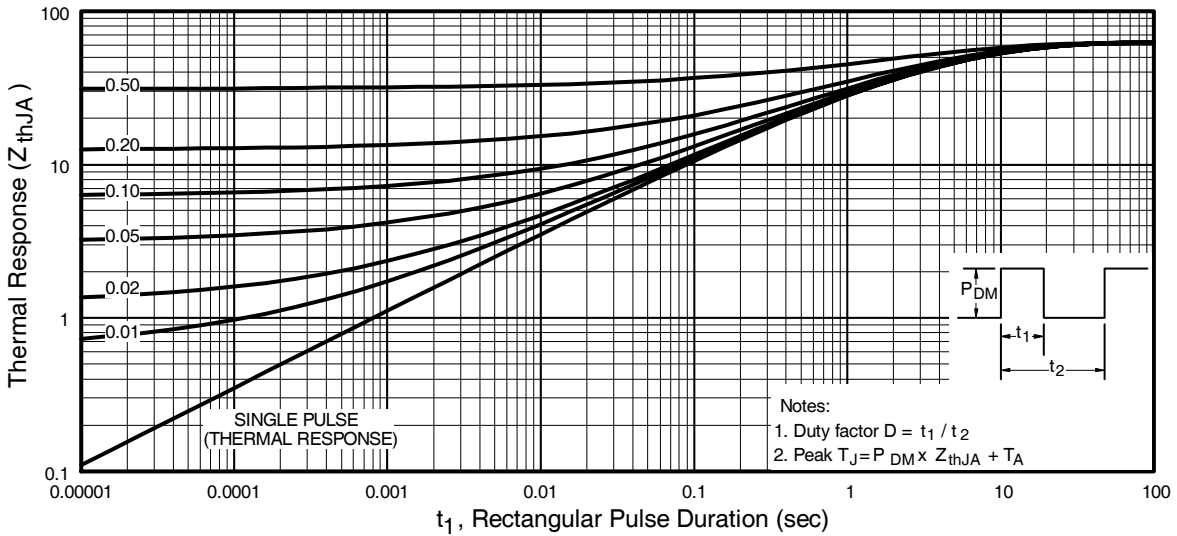

Fig 11. Maximum Effective Transient Thermal Impedance, Junction-to-Ambient

IRF7317PbF

P-Channel

International
IR Rectifier

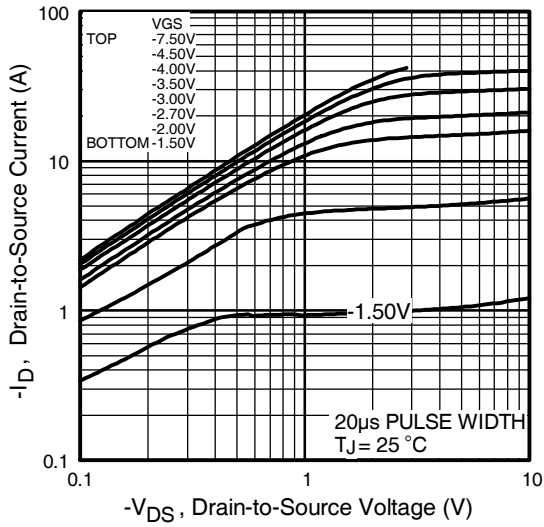

Fig 12. Typical Output Characteristics

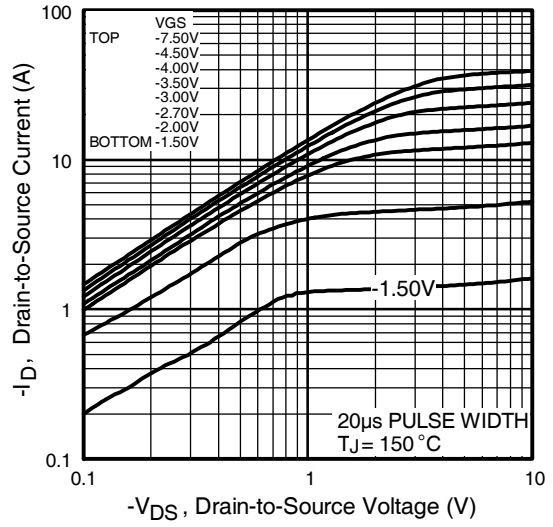

Fig 13. Typical Output Characteristics

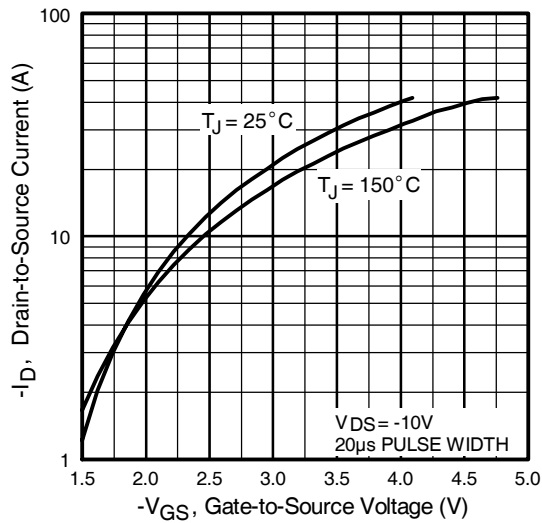

Fig 14. Typical Transfer Characteristics

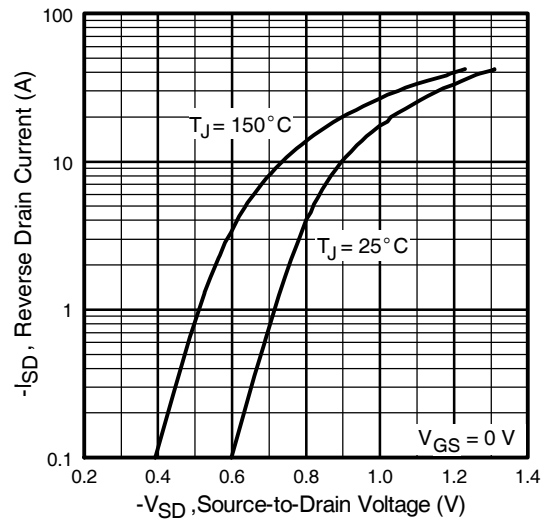

Fig 15. Typical Source-Drain Diode Forward Voltage

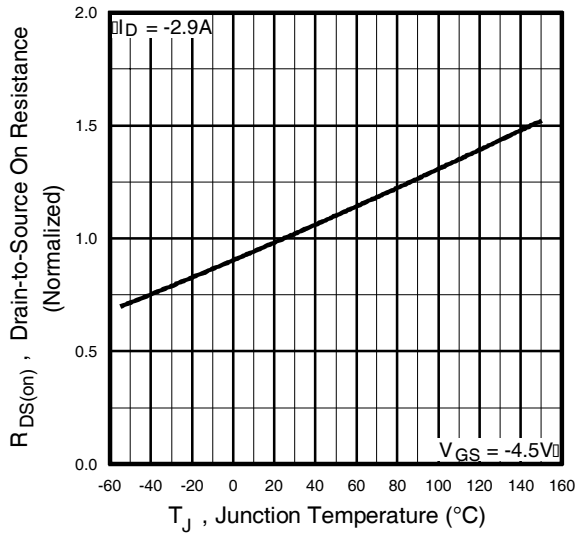

Fig 16. Normalized On-Resistance Vs. Temperature

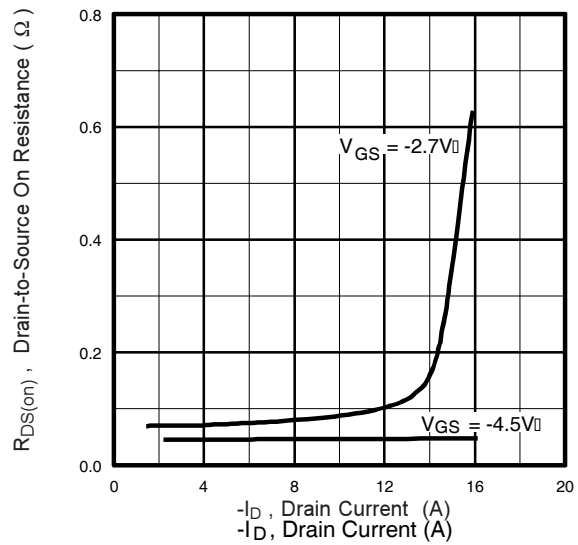

Fig 17. Typical On-Resistance Vs. Drain Current

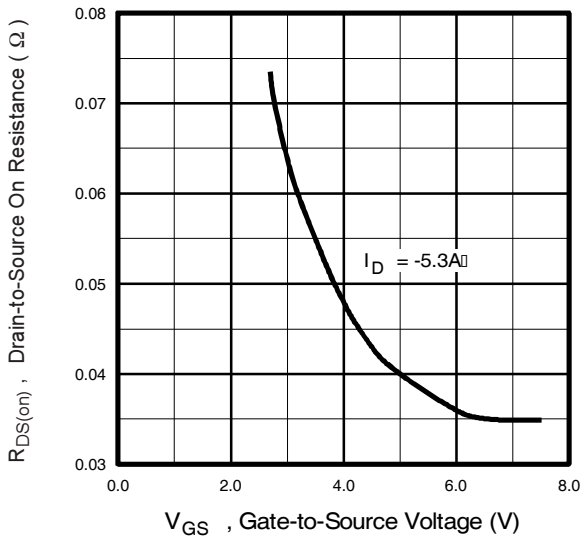

Fig 18. Typical On-Resistance Vs. Gate Voltage

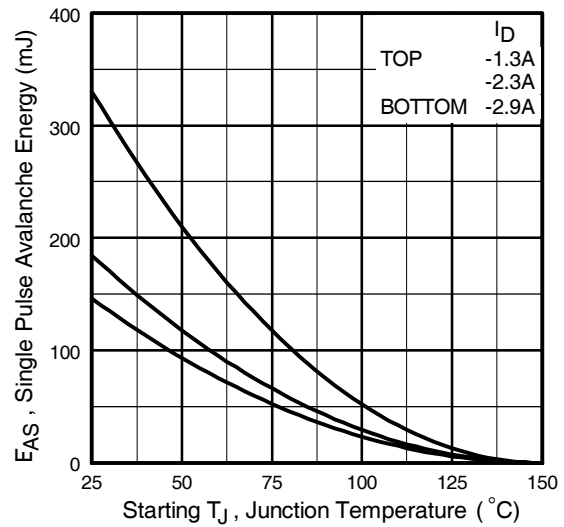

Fig 19. Maximum Avalanche Energy Vs. Drain Current

IRF7317PbF

P-Channel

International
IR Rectifier

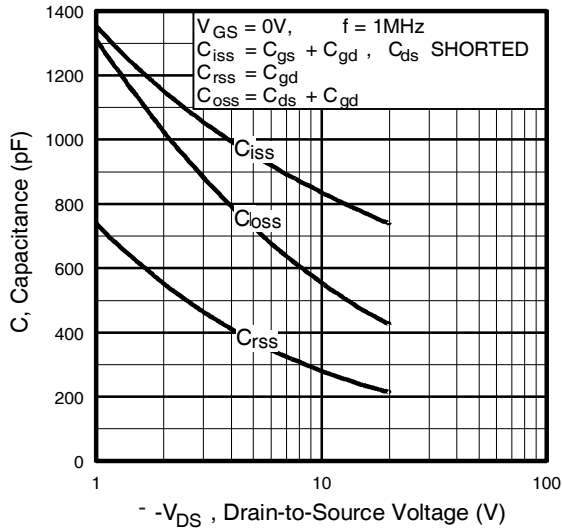

Fig 20. Typical Capacitance Vs. Drain-to-Source Voltage

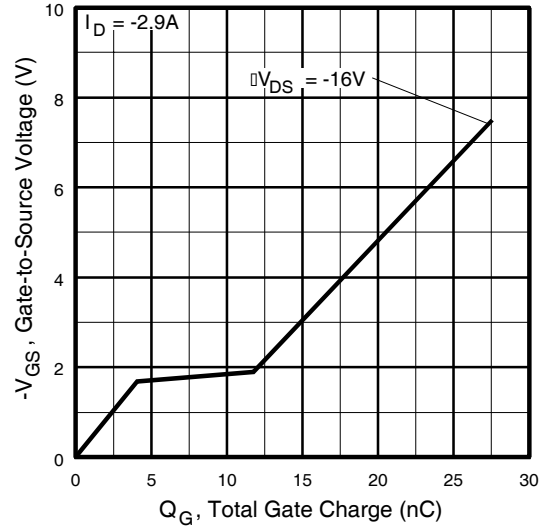

Fig 21. Typical Gate Charge Vs. Gate-to-Source Voltage

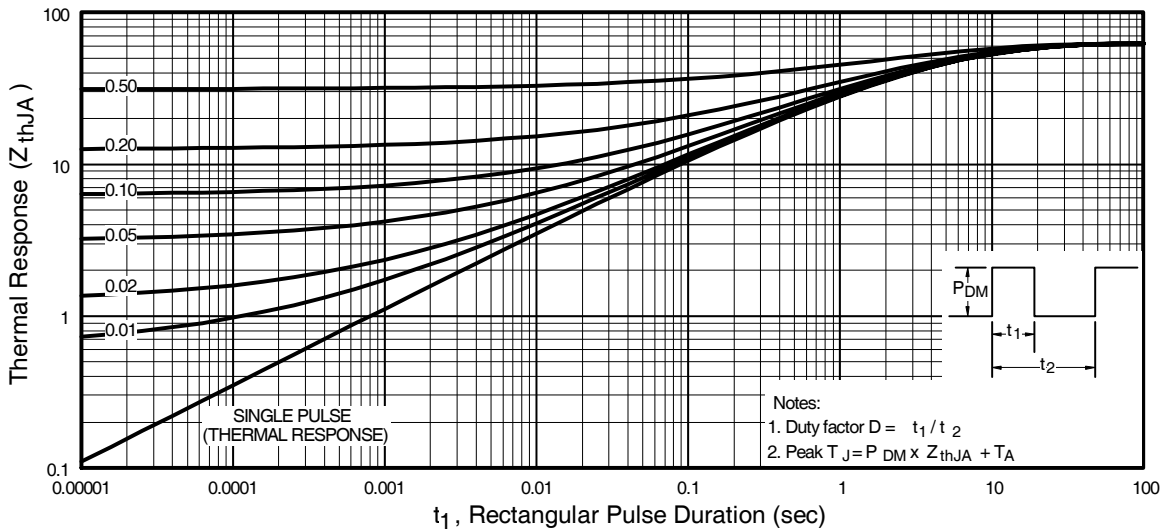
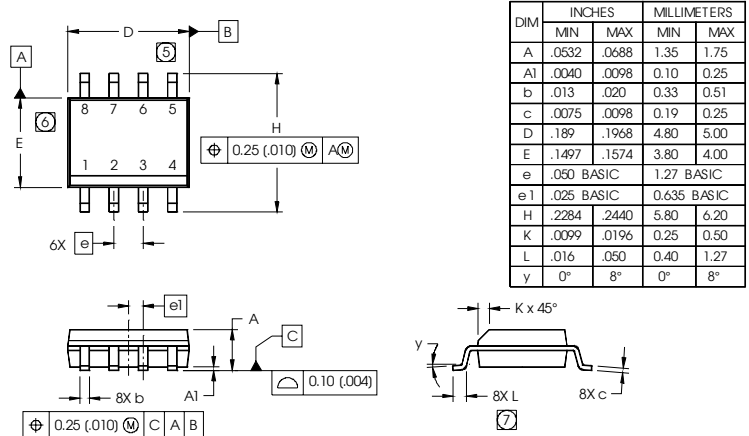

Fig 22. Maximum Effective Transient Thermal Impedance, Junction-to-Ambient

SO-8 Package Outline

Dimensions are shown in millimeters (inches)



NOTES:

1. DIMENSIONING & TOLERANCING PER ASME Y14.5M-1994.
2. CONTROLLING DIMENSION: MILLIMETER
3. DIMENSIONS ARE SHOWN IN MILLIMETERS (INCHES).
4. OUTLINE CONFORMS TO JEDEC OUTLINE MS-012AA.
- 5 DIMENSION DOES NOT INCLUDE MOLD PROTRUSIONS. MOLD PROTRUSIONS NOT TO EXCEED 0.15 (.006).
- 6 DIMENSION DOES NOT INCLUDE MOLD PROTRUSIONS. MOLD PROTRUSIONS NOT TO EXCEED 0.25 (.010).
- 7 DIMENSION IS THE LENGTH OF LEAD FOR SOLDERING TO A SUBSTRATE.

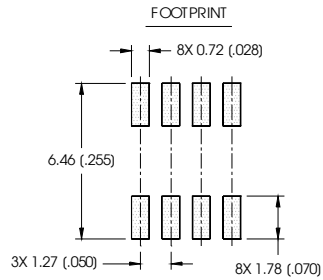

SO-8 Part Marking Information (Lead-Free)

EXAMPLE: THIS IS AN IRF7101 (MOSFET)

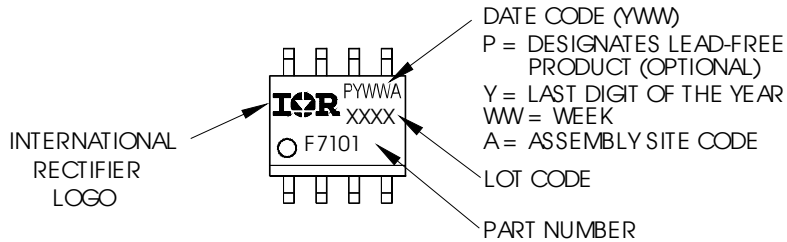

IRF7317PbF

International
IR Rectifier

SO-8 Tape and Reel

Dimensions are shown in millimeters (inches)

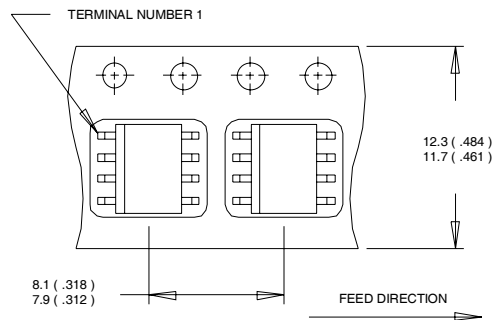

NOTES:

1. CONTROLLING DIMENSION : MILLIMETER.
2. ALL DIMENSIONS ARE SHOWN IN MILLIMETERS(INCHES).
3. OUTLINE CONFORMS TO EIA-481 & EIA-541.

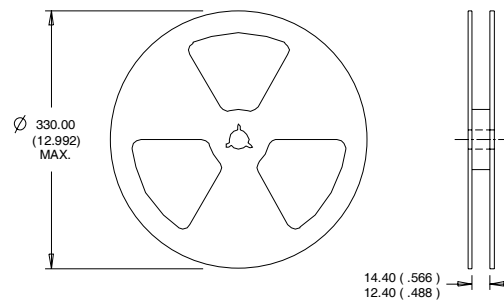

NOTES :

1. CONTROLLING DIMENSION : MILLIMETER.
2. OUTLINE CONFORMS TO EIA-481 & EIA-541.

Data and specifications subject to change without notice.
This product has been designed and qualified for the Consumer market.
Qualification Standards can be found on IR's Web site.

International
IR Rectifier

IR WORLD HEADQUARTERS: 233 Kansas St., El Segundo, California 90245, USA Tel: (310) 252-7105

TAC Fax: (310) 252-7903

Visit us at www.irf.com for sales contact information.05/04