

DirectFET® N-Channel Power MOSFET

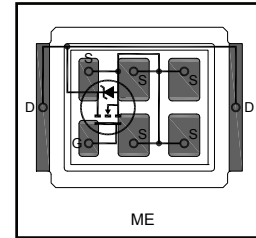
Application

- Brushed Motor drive applications
- BLDC Motor drive applications
- Battery powered circuits
- Half-bridge and full-bridge topologies
- Synchronous rectifier applications
- Resonant mode power supplies
- OR-ing and redundant power switches
- DC/DC and AC/DC converters
- DC/AC Inverters

Benefits

- Improved Gate, Avalanche and Dynamic dv/dt Ruggedness
- Fully Characterized Capacitance and Avalanche SOA
- Enhanced body diode dv/dt and di/dt Capability
- Lead-Free, RoHS Compliant

| | |
|---|---------------|
| V_{DSS} | 40V |
| R_{DS(on)} typ. | 0.95mΩ |
| | max |
| I_D (Silicon Limited) | 217A |
| I_D (double-sided cooling) | 330A |



| Base part number | Package Type | Standard Pack | | Orderable Part Number |
|------------------|---------------|---------------|----------|-----------------------|
| | | Form | Quantity | |
| IRF7480MPbF | DirectFET® ME | Tape and Reel | 4800 | IRF7480MTRPbF |

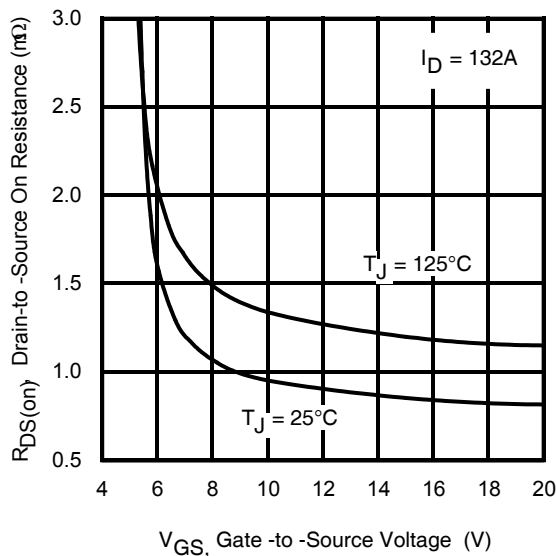


Fig 1. Typical On-Resistance vs. Gate Voltage

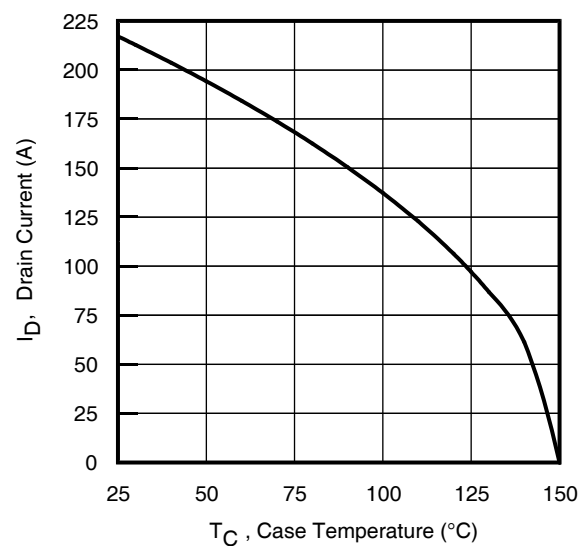


Fig 2. Maximum Drain Current vs. Case Temperature

Absolute Maximum Ratings

| Symbol | Parameter | Max. | Units |
|---|---|--------------|-------|
| I_D @ T_C (top) = 25°C T_C (bottom) = 25°C | Continuous Drain Current, V_{GS} @ 10V (double-sided cooling) | 330 | A |
| I_D @ T_C = 25°C | Continuous Drain Current, V_{GS} @ 10V (Silicon Limited) | 217 | |
| I_D @ T_C = 100°C | Continuous Drain Current, V_{GS} @ 10V (Silicon Limited) | 137 | |
| I_{DM} | Pulsed Drain Current ① | 868 | |
| P_D @ T_C = 25°C | Maximum Power Dissipation | 96 | W |
| | Linear Derating Factor | 0.77 | W/°C |
| V_{GS} | Gate-to-Source Voltage | ± 20 | V |
| T_J T_{STG} | Operating Junction and Storage Temperature Range | -55 to + 150 | °C |

Avalanche Characteristics

| | | | |
|------------------------------|---------------------------------|-------------------------|----|
| E_{AS} (Thermally limited) | Single Pulse Avalanche Energy ② | 81 | mJ |
| E_{AS} (Thermally limited) | Single Pulse Avalanche Energy ③ | 206 | |
| I_{AR} | Avalanche Current ① | See Fig.15,16, 23a, 23b | A |
| E_{AR} | Repetitive Avalanche Energy ① | | mJ |

Thermal Resistance

| Symbol | Parameter | Typ. | Max. | Units |
|--------------------|-------------------------|------|------|-------|
| $R_{\theta JA}$ | Junction-to-Ambient ① | — | 45 | °C/W |
| $R_{\theta JA}$ | Junction-to-Ambient ③ | 12.5 | — | |
| $R_{\theta JA}$ | Junction-to-Ambient ② | 20 | — | |
| $R_{\theta JC}$ | Junction-to-Case ④⑤ | — | 1.3 | |
| $R_{\theta J-PCB}$ | Junction-to-PCB Mounted | 0.75 | — | |

Static @ $T_J = 25^\circ\text{C}$ (unless otherwise specified)

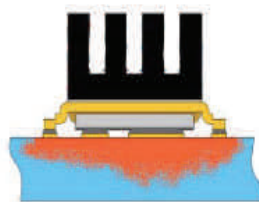
| Symbol | Parameter | Min. | Typ. | Max. | Units | Conditions |
|---------------------------------|--------------------------------------|------|------|------|-------|--|
| $V_{(BR)DSS}$ | Drain-to-Source Breakdown Voltage | 40 | — | — | V | $V_{GS} = 0V, I_D = 250\mu A$ |
| $\Delta V_{(BR)DSS}/\Delta T_J$ | Breakdown Voltage Temp. Coefficient | — | 30 | — | mV/°C | Reference to 25°C, $I_D = 1.0mA$ ① |
| $R_{DS(on)}$ | Static Drain-to-Source On-Resistance | — | 0.95 | 1.20 | mΩ | $V_{GS} = 10V, I_D = 132A$ ④ |
| | | — | 1.60 | — | | $V_{GS} = 6.0V, I_D = 66A$ ④ |
| $V_{GS(th)}$ | Gate Threshold Voltage | 2.1 | 3.0 | 3.9 | V | $V_{DS} = V_{GS}, I_D = 150\mu A$ |
| I_{DSS} | Drain-to-Source Leakage Current | — | — | 1.0 | μA | $V_{DS} = 40V, V_{GS} = 0V$ |
| | | — | — | 150 | | $V_{DS} = 40V, V_{GS} = 0V, T_J = 125^\circ\text{C}$ |
| I_{GSS} | Gate-to-Source Forward Leakage | — | — | 100 | nA | $V_{GS} = 20V$ |
| | Gate-to-Source Reverse Leakage | — | — | -100 | | $V_{GS} = -20V$ |
| R_G | Internal Gate Resistance | — | 0.81 | — | Ω | |

Notes:

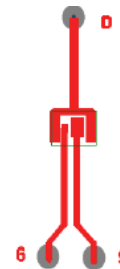
- ① Mounted on minimum footprint full size board with metalized back and with small clip heatsink.
- ② Used double sided cooling, mounting pad with large heatsink.
- ③ TC measured with thermocouple mounted to top (Drain) of part.



① Surface mounted on 1 in. square Cu board (still air).



② Mounted to a PCB with small clip heatsink (still air)

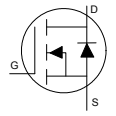


③ Mounted on minimum footprint full size board with metalized back and with small clip heatsink (still air)

Dynamic @ $T_J = 25^\circ\text{C}$ (unless otherwise specified)

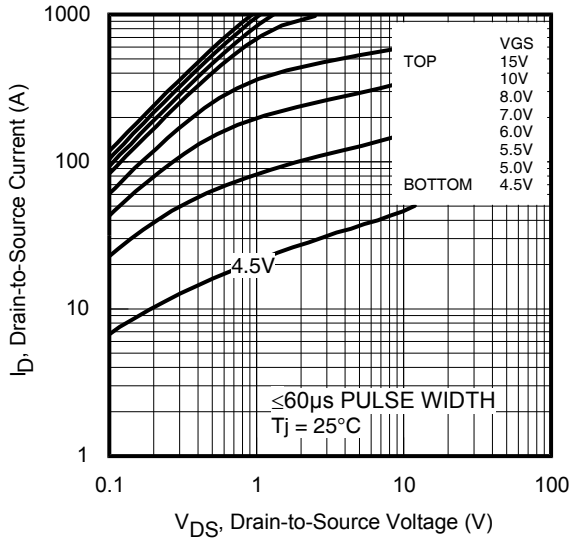
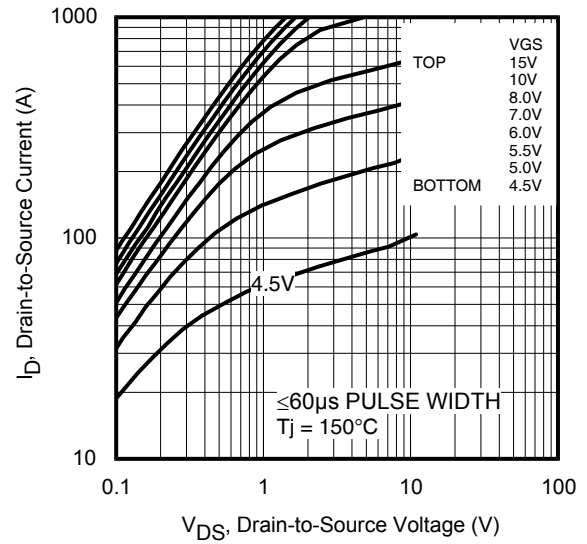
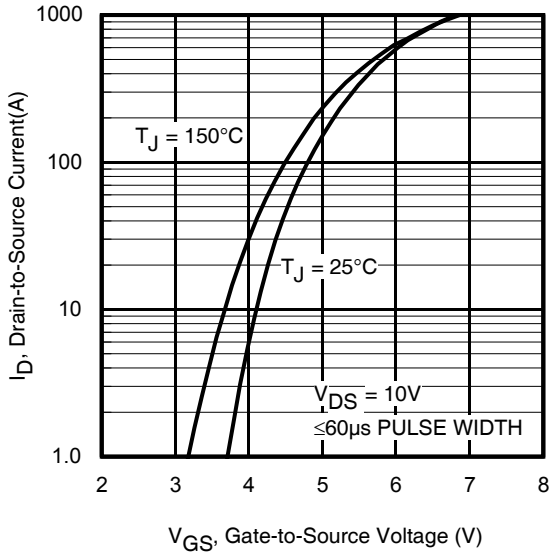
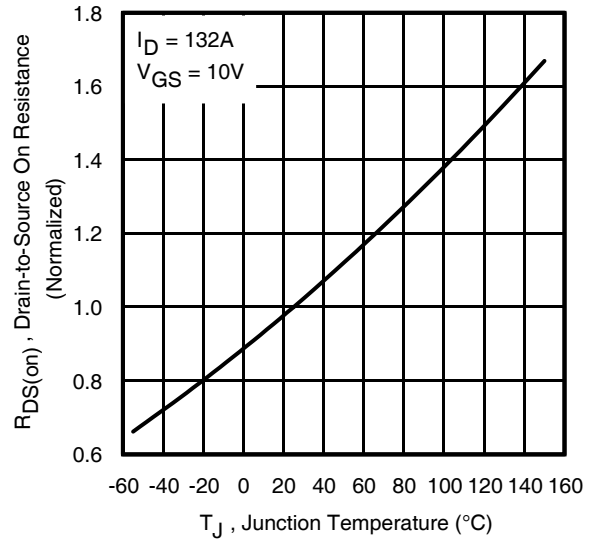
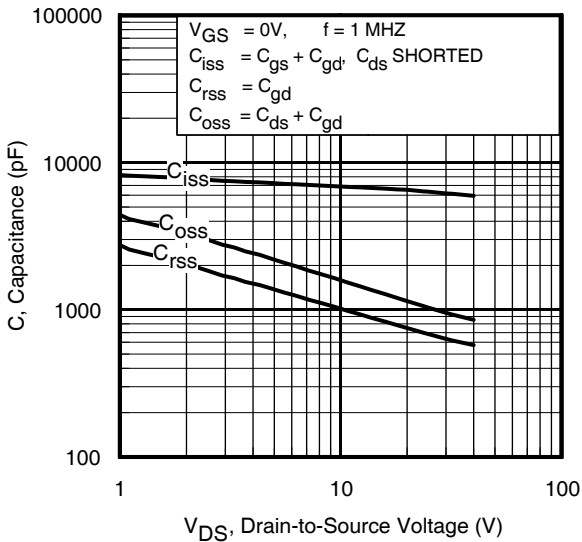
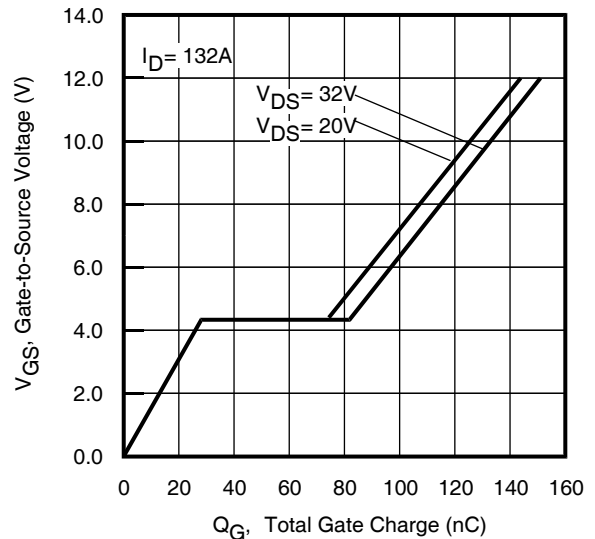
| Symbol | Parameter | Min. | Typ. | Max. | Units | Conditions |
|---------------------|---|------|------|------|-------|---|
| g_{fs} | Forward Transconductance | 370 | — | — | S | $V_{DS} = 10V, I_D = 132A$ |
| Q_g | Total Gate Charge | — | 123 | 185 | nC | $I_D = 132A$ $V_{DS} = 20V$ $V_{GS} = 10V$ ④ $I_D = 132A, V_{DS} = 0V, V_{GS} = 10V$ |
| Q_{gs} | Gate-to-Source Charge | — | 31 | — | | |
| Q_{gd} | Gate-to-Drain ("Miller") Charge | — | 44 | — | | |
| Q_{sync} | Total Gate Charge Sync. ($Q_g - Q_{gd}$) | — | 79 | — | | |
| $t_{d(on)}$ | Turn-On Delay Time | — | 21 | — | ns | $V_{DD} = 20V$ $I_D = 30A$ $R_G = 2.7\Omega$ $V_{GS} = 10V$ ④ |
| t_r | Rise Time | — | 70 | — | | |
| $t_{d(off)}$ | Turn-Off Delay Time | — | 68 | — | | |
| t_f | Fall Time | — | 58 | — | | |
| C_{iss} | Input Capacitance | — | 6680 | — | pF | $V_{GS} = 0V$ $V_{DS} = 25V$ $f = 1.0MHz$ $V_{GS} = 0V, V_{DS} = 0V$ to 32V ⑥ $V_{GS} = 0V, V_{DS} = 0V$ to 32V ⑤ |
| C_{oss} | Output Capacitance | — | 1035 | — | | |
| C_{rss} | Reverse Transfer Capacitance | — | 700 | — | | |
| C_{oss} eff. (ER) | Effective Output Capacitance (Energy Related) | — | 1240 | — | | |
| C_{oss} eff. (TR) | Effective Output Capacitance (Time Related) | — | 1515 | — | | |

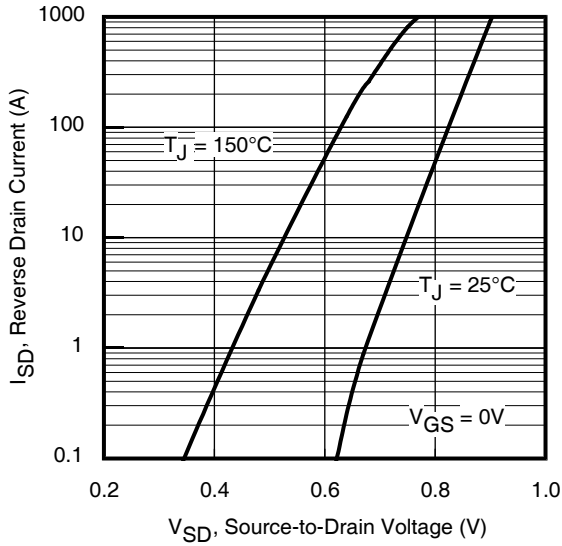
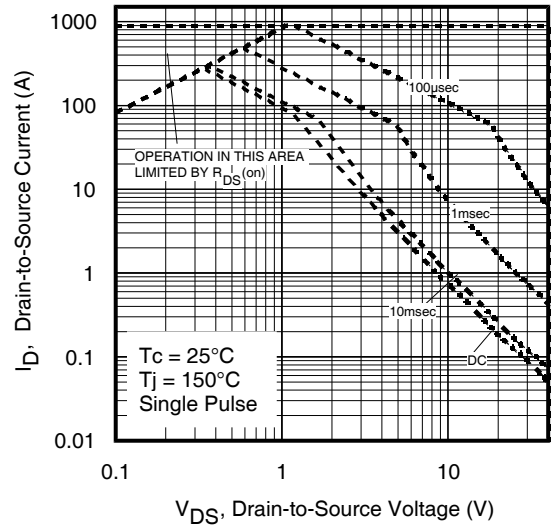
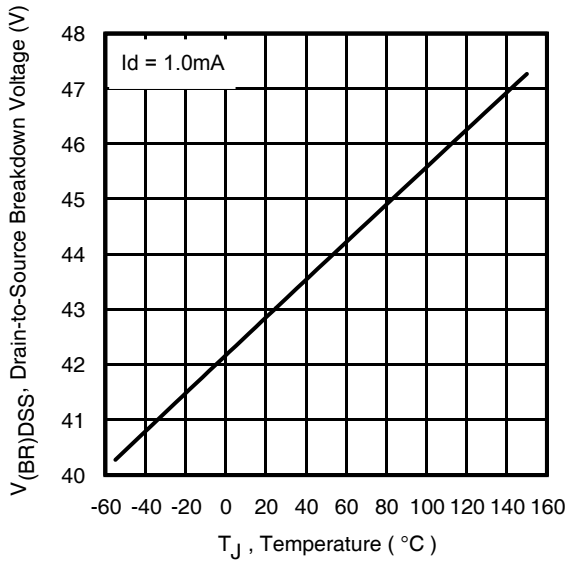
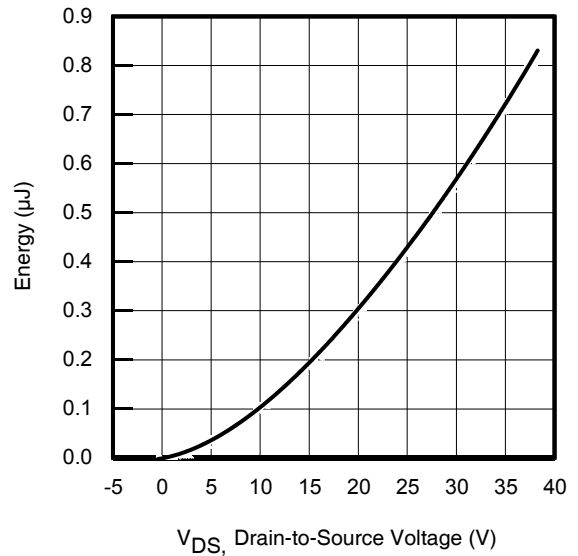
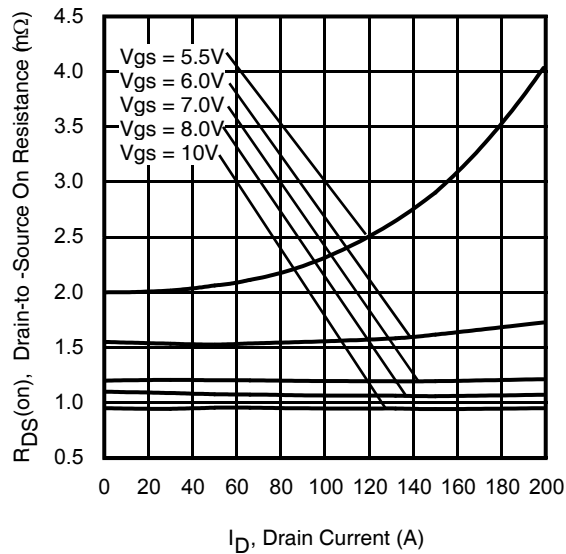
Diode Characteristics

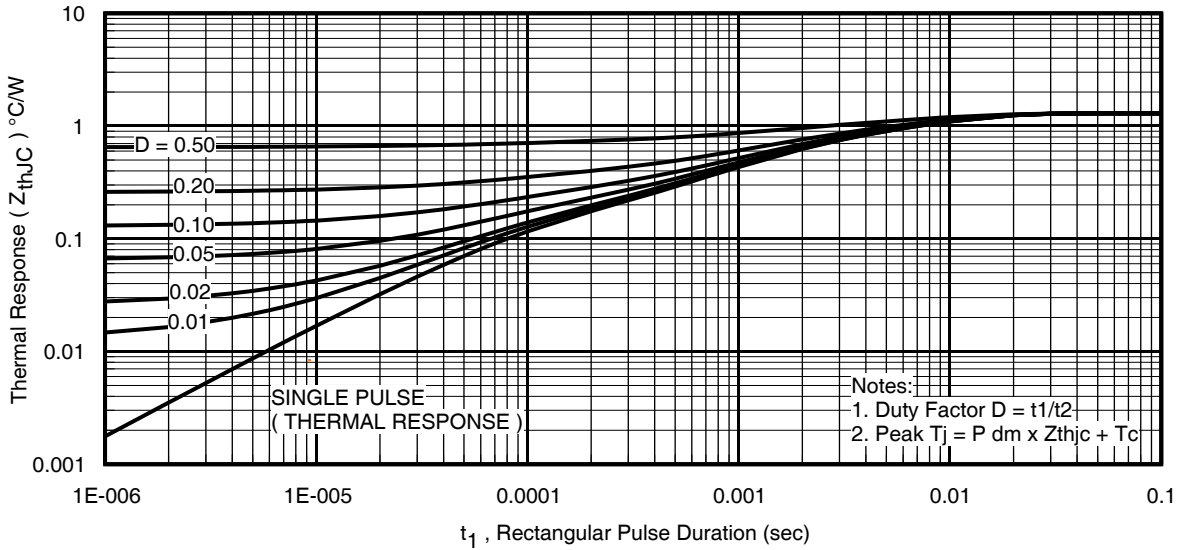
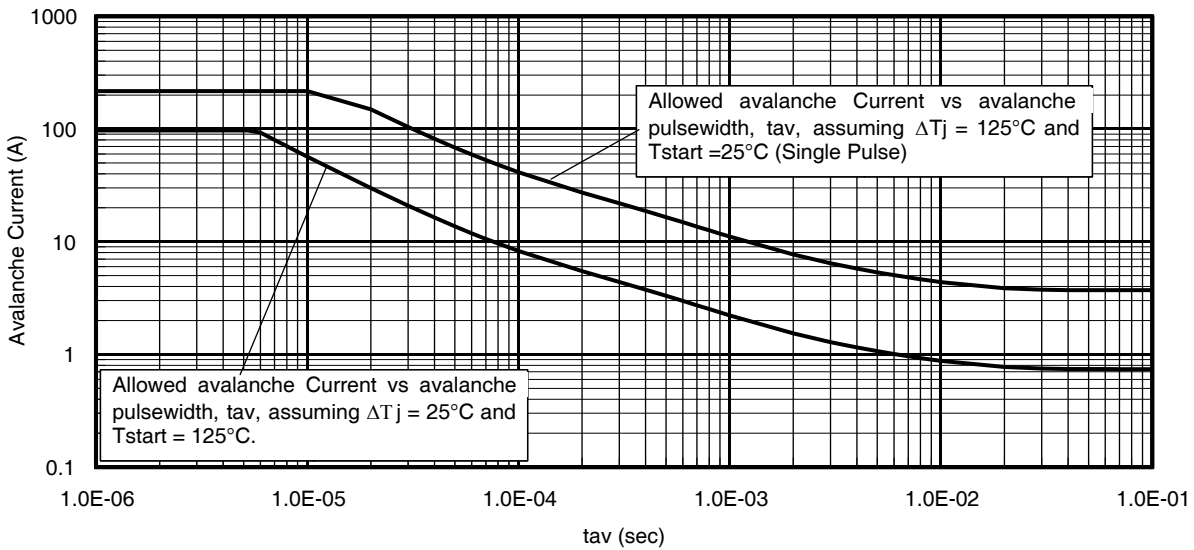
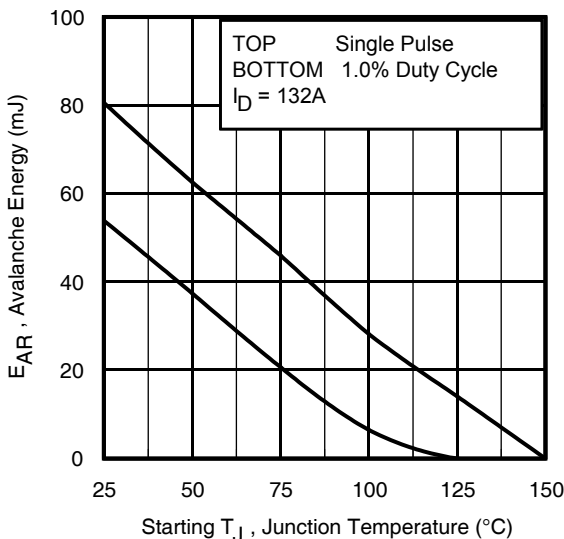
| Symbol | Parameter | Min. | Typ. | Max. | Units | Conditions |
|-----------|--|------|------|------|-------|--|
| I_S | Continuous Source Current (Body Diode) | — | — | 87 | A | MOSFET symbol showing the integral reverse p-n junction diode.  |
| I_{SM} | Pulsed Source Current (Body Diode) ① | — | — | 868 | | |
| V_{SD} | Diode Forward Voltage | — | — | 1.2 | V | $T_J = 25^\circ\text{C}, I_S = 132A, V_{GS} = 0V$ ④ |
| dv/dt | Peak Diode Recovery ③ | — | 2.4 | — | V/ns | $T_J = 150^\circ\text{C}, I_S = 132A, V_{DS} = 40V$ |
| t_{rr} | Reverse Recovery Time | — | 44 | — | ns | $T_J = 25^\circ\text{C}$ $V_R = 34V,$ $T_J = 125^\circ\text{C}$ $I_F = 132A$ |
| Q_{rr} | Reverse Recovery Charge | — | 56 | — | | |
| | | — | 63 | — | nC | $T_J = 25^\circ\text{C}$ $di/dt = 100A/\mu s$ ④ $T_J = 125^\circ\text{C}$ |
| I_{RRM} | Reverse Recovery Current | — | 2.1 | — | A | $T_J = 25^\circ\text{C}$ |

Notes:

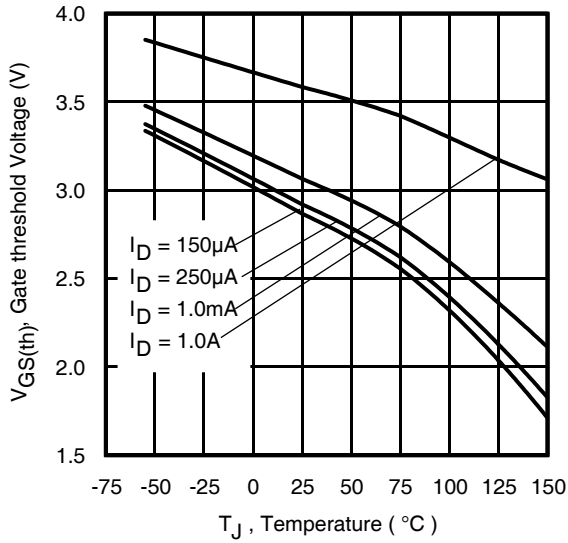
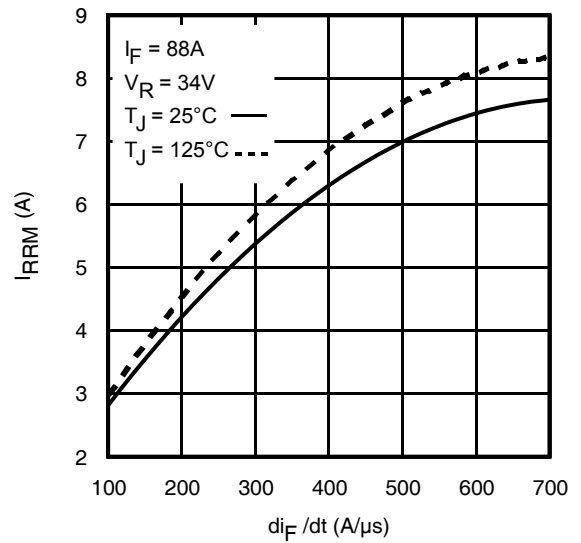
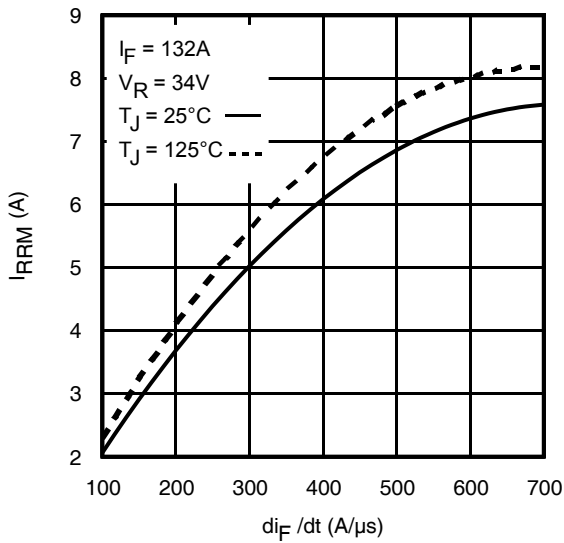
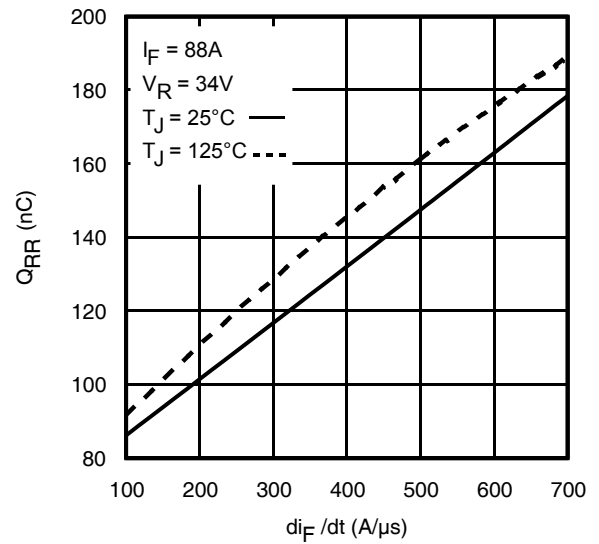
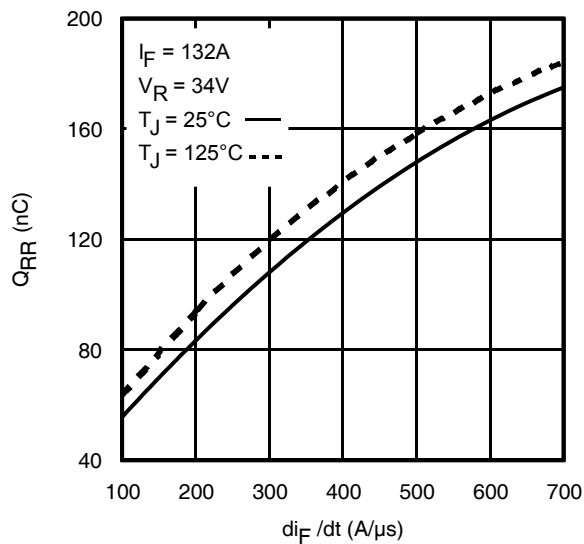
- ① Repetitive rating; pulse width limited by max. junction temperature.
- ② Limited by T_{Jmax} , starting $T_J = 25^\circ\text{C}$, $L = 0.009mH$, $R_G = 50\Omega$, $I_{AS} = 132A$, $V_{GS} = 10V$.
- ③ $I_{SD} \leq 132A$, $di/dt \leq 920A/\mu s$, $V_{DD} \leq V_{(BR)DSS}$, $T_J \leq 150^\circ\text{C}$.
- ④ Pulse width $\leq 400\mu s$; duty cycle $\leq 2\%$.
- ⑤ C_{oss} eff. (TR) is a fixed capacitance that gives the same charging time as C_{oss} while V_{DS} is rising from 0 to 80% V_{DSS} .
- ⑥ C_{oss} eff. (ER) is a fixed capacitance that gives the same energy as C_{oss} while V_{DS} is rising from 0 to 80% V_{DSS} .
- ⑦ When mounted on 1" square PCB (FR-4 or G-10 Material). For recommended footprint and soldering techniques refer to application note # AN-994. <http://www.irf.com/technical-info/appnotes/an-994.pdf>
- ⑧ R_θ is measured at T_J approximately 90°C .
- ⑨ Limited by T_{Jmax} , starting $T_J = 25^\circ\text{C}$, $L = 1mH$, $R_G = 50\Omega$, $I_{AS} = 20A$, $V_{GS} = 10V$.

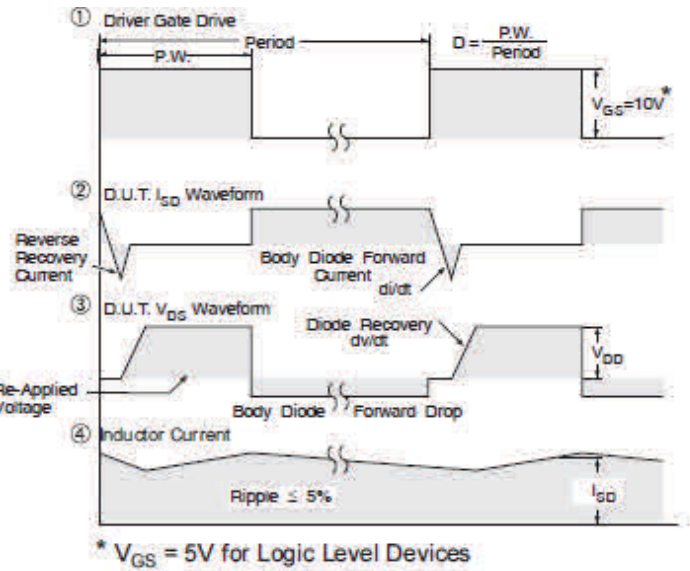
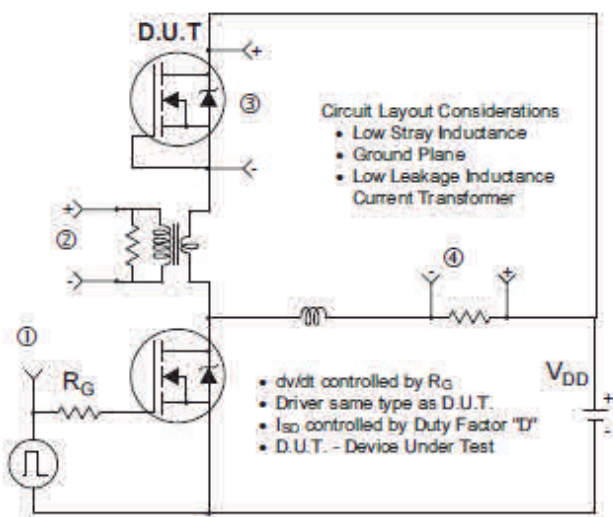
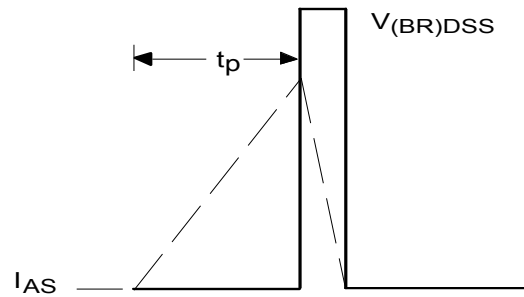
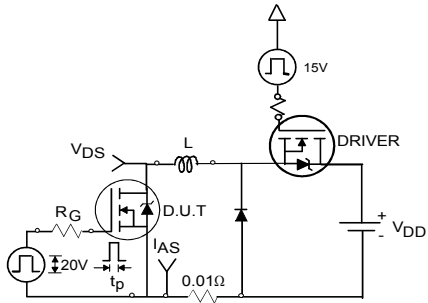
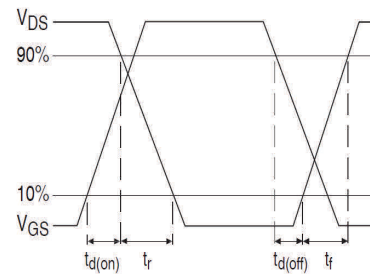
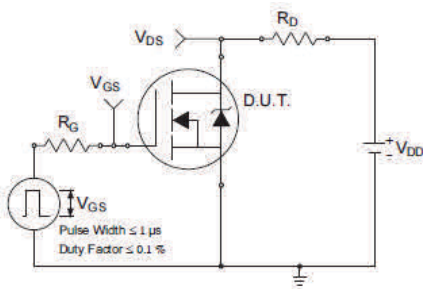
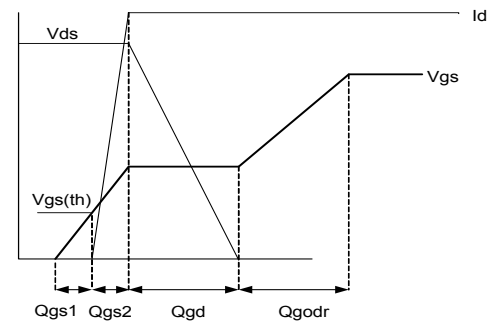
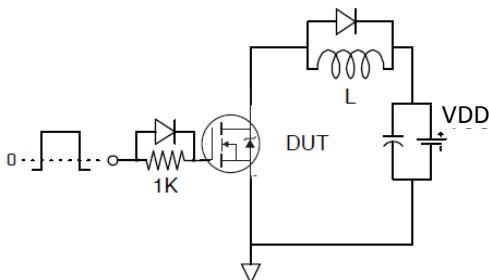

Fig 3. Typical Output Characteristics

Fig 4. Typical Output Characteristics

Fig 5. Typical Transfer Characteristics

Fig 6. Normalized On-Resistance vs. Temperature

Fig 7. Typical Capacitance vs. Drain-to-Source Voltage

Fig 8. Typical Gate Charge vs. Gate-to-Source Voltage


Fig 9. Typical Source-Drain Diode Forward Voltage

Fig 10. Maximum Safe Operating Area

Fig 11. Drain-to-Source Breakdown Voltage

Fig 12. Typical C_{oss} Stored Energy

Fig 13. Typical On-Resistance vs. Drain Current


Fig 14. Maximum Effective Transient Thermal Impedance, Junction-to-Case

Fig 15. Avalanche Current vs. Pulse Width

Fig 16. Maximum Avalanche Energy vs. Temperature
**Notes on Repetitive Avalanche Curves , Figures 15, 16:
(For further info, see AN-1005 at www.irf.com)**

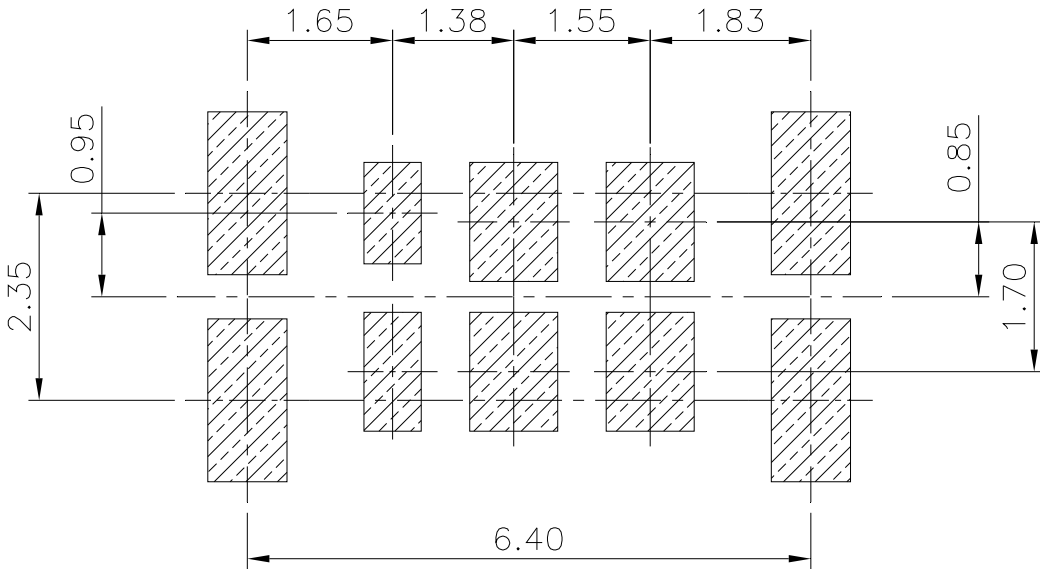
1. Avalanche failures assumption:
Purely a thermal phenomenon and failure occurs at a temperature far in excess of T_{jmax} . This is validated for every part type.
2. Safe operation in Avalanche is allowed as long as T_{jmax} is not exceeded.
3. Equation below based on circuit and waveforms shown in Figures 23a, 23b.
4. $P_{D(ave)}$ = Average power dissipation per single avalanche pulse.
5. BV = Rated breakdown voltage (1.3 factor accounts for voltage increase during avalanche).
6. I_{av} = Allowable avalanche current.
7. ΔT = Allowable rise in junction temperature, not to exceed T_{jmax} (assumed as 25°C in Figure 14, 15).
 t_{av} = Average time in avalanche.
 D = Duty cycle in avalanche = $t_{av} \cdot f$
 $Z_{thJC}(D, t_{av})$ = Transient thermal resistance, see Figures 13)
 $P_{D(ave)} = 1/2 (1.3 \cdot BV \cdot I_{av}) = \Delta T / Z_{thJC}$
 $I_{av} = 2\Delta T / [1.3 \cdot BV \cdot Z_{th}]$
 $E_{AS(AR)} = P_{D(ave)} \cdot t_{av}$


Fig 17. Threshold Voltage vs. Temperature

Fig 18. Typical Recovery Current vs. di_F/dt

Fig 19. Typical Recovery Current vs. di_F/dt

Fig 20. Typical Stored Charge vs. di_F/dt

Fig 21. Typical Stored Charge vs. di_F/dt

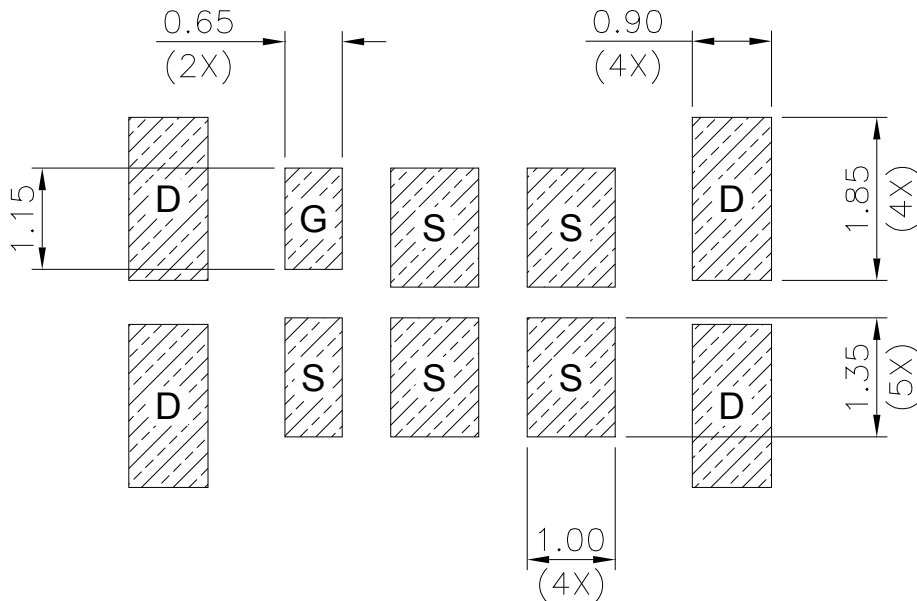

Fig 22. Peak Diode Recovery dv/dt Test Circuit for N-Channel HEXFET® Power MOSFETs

Fig 23a. Unclamped Inductive Test Circuit
Fig 23b. Unclamped Inductive Waveforms

Fig 24a. Switching Time Test Circuit
Fig 24b. Switching Time Waveforms

Fig 25a. Gate Charge Test Circuit
Fig 25b. Gate Charge Waveform

**DirectFET® Board Footprint, ME Outline
(Medium Size Can, E-Designation)**

Please see DirectFET® application note AN-1035 for all details regarding the assembly of DirectFET®. This includes all recommendations for stencil and substrate designs.



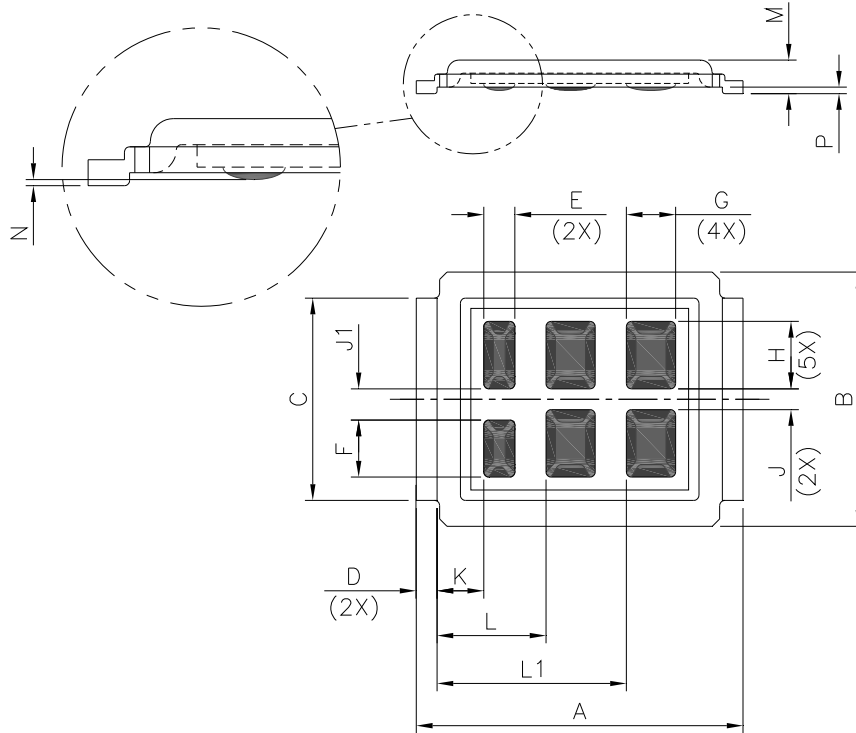
G = GATE
D = DRAIN
S = SOURCE



Note: For the most current drawing please refer to IR website at <http://www.irf.com/package/>

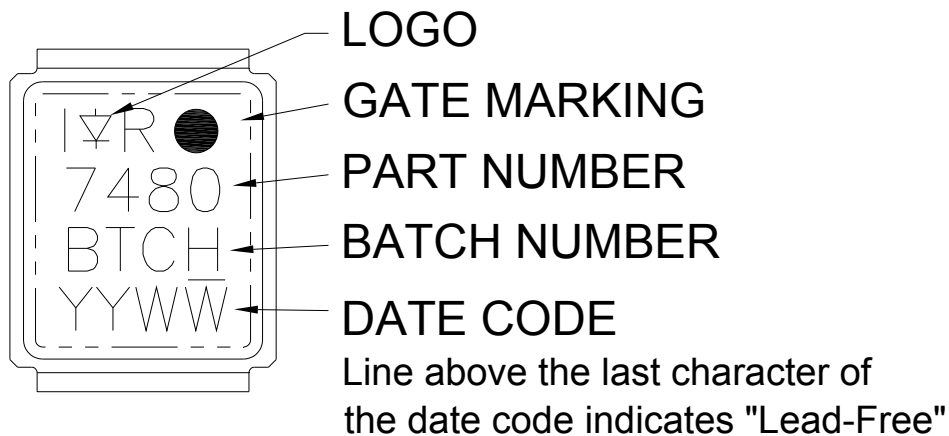
**DirectFET® Outline Dimension, ME Outline
(Medium Size Can, E-Designation)**

Please see DirectFET® application note AN-1035 for all details regarding the assembly of DirectFET®. This includes all recommendations for stencil and substrate designs.

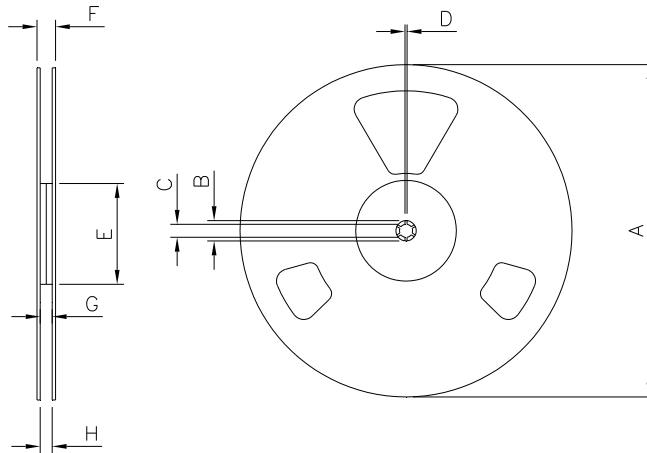


| CODE | METRIC | | IMPERIAL | |
|------|--------|------|----------|-------|
| | MIN | MAX | MIN | MAX |
| A | 6.25 | 6.35 | 0.246 | 0.250 |
| B | 4.80 | 5.05 | 0.189 | 0.199 |
| C | 3.85 | 3.95 | 0.152 | 0.156 |
| D | 0.35 | 0.45 | 0.014 | 0.018 |
| E | 0.58 | 0.62 | 0.023 | 0.024 |
| F | 1.08 | 1.12 | 0.043 | 0.044 |
| G | 0.93 | 0.97 | 0.037 | 0.038 |
| H | 1.28 | 1.32 | 0.050 | 0.052 |
| J | 0.38 | 0.42 | 0.015 | 0.017 |
| J1 | 0.58 | 0.62 | 0.023 | 0.024 |
| K | 0.88 | 0.92 | 0.035 | 0.036 |
| L | 2.08 | 2.12 | 0.082 | 0.083 |
| L1 | 3.63 | 3.67 | 0.143 | 0.144 |
| M | 0.59 | 0.70 | 0.023 | 0.028 |
| N | 0.02 | 0.08 | 0.0008 | 0.003 |
| P | 0.08 | 0.17 | 0.003 | 0.007 |

Dimensions are shown in millimeters (inches)

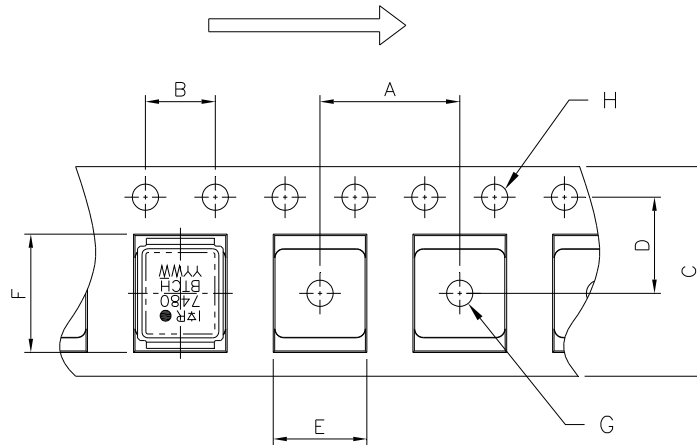
DirectFET® Part Marking


Note: For the most current drawing please refer to IR website at <http://www.irf.com/package/>

DirectFET® Tape & Reel Dimension (Showing component orientation).


NOTE: Controlling dimensions in mm
 Std reel quantity is 4800 parts. (ordered as IRF7480MTRPbF). For 1000 parts on 7" reel, order IRF7480MTR1PbF

| REEL DIMENSIONS | | | | | | | | |
|-----------------|----------------------------|------|----------|-------|-----------------------|-------|----------|------|
| CODE | STANDARD OPTION (QTY 4800) | | | | TR1 OPTION (QTY 1000) | | | |
| | METRIC | | IMPERIAL | | METRIC | | IMPERIAL | |
| | MIN | MAX | MIN | MAX | MIN | MAX | MIN | MAX |
| A | 330.0 | N.C | 12.992 | N.C | 177.77 | N.C | 6.9 | N.C |
| B | 20.2 | N.C | 0.795 | N.C | 19.06 | N.C | 0.75 | N.C |
| C | 12.8 | 13.2 | 0.504 | 0.520 | 13.5 | 12.8 | 0.53 | 0.50 |
| D | 1.5 | N.C | 0.059 | N.C | 1.5 | N.C | 0.059 | N.C |
| E | 100.0 | N.C | 3.937 | N.C | 58.72 | N.C | 2.31 | N.C |
| F | N.C | 18.4 | N.C | 0.724 | N.C | 13.50 | N.C | 0.53 |
| G | 12.4 | 14.4 | 0.488 | 0.567 | 11.9 | 12.01 | 0.47 | N.C |
| H | 11.9 | 15.4 | 0.469 | 0.606 | 11.9 | 12.01 | 0.47 | N.C |

LOADED TAPE FEED DIRECTION


NOTE: CONTROLLING DIMENSIONS IN MM

| DIMENSIONS | | | | |
|------------|--------|-------|----------|-------|
| CODE | METRIC | | IMPERIAL | |
| | MIN | MAX | MIN | MAX |
| A | 7.90 | 8.10 | 0.311 | 0.319 |
| B | 3.90 | 4.10 | 0.154 | 0.161 |
| C | 11.90 | 12.30 | 0.469 | 0.484 |
| D | 5.45 | 5.55 | 0.215 | 0.219 |
| E | 5.10 | 5.30 | 0.201 | 0.209 |
| F | 6.50 | 6.70 | 0.256 | 0.264 |
| G | 1.50 | N.C | 0.059 | N.C |
| H | 1.50 | 1.60 | 0.059 | 0.063 |

Note: For the most current drawing please refer to IR website at <http://www.irf.com/package/>

Qualification Information†

| | | |
|-----------------------------------|--|----------------------------------|
| Qualification Level | Industrial * (per JEDEC JESD47F†† guidelines) | |
| Moisture Sensitivity Level | DFET 1.5 | MSL1 (per JEDEC J-STD-020D††) |
| RoHS Compliant | Yes | |

† Qualification standards can be found at International Rectifier's web site

<http://www.irf.com/product-info/reliability>

†† Applicable version of JEDEC standard at the time of product release.

* Industrial qualification standards except autoclave test conditions.

Revision History

| Date | Comments |
|-------------|---|
| 11/07/2014 | <ul style="list-style-type: none"> Updated $E_{AS(L=1mH)} = 206mJ$ on page 2 Updated note 9 "Limited by T_{Jmax}, starting $T_J = 25^{\circ}C$, $L = 1mH$, $R_G = 50\Omega$, $I_{AS} = 20A$, $V_{GS} = 10V$" on page 3 Updated $R\theta JA$ from "60°C/W" to "45°C/W" on page 2. |
| 05/14/2015 | <ul style="list-style-type: none"> Updated registered trademark from DirectFET™ to DirectFET® on page 1,9 and 10. |
| 05/04/2016 | <ul style="list-style-type: none"> Updated datasheet with corporate template. Added ID (double- sided cooling) = 300A on pages1 and 2. |

Published by

Infineon Technologies AG

81726 München, Germany

© Infineon Technologies AG 2015

All Rights Reserved.

IMPORTANT NOTICE

The information given in this document shall in no event be regarded as a guarantee of conditions or characteristics ("Beschaffenhheitsgarantie"). With respect to any examples, hints or any typical values stated herein and/or any information regarding the application of the product, Infineon Technologies hereby disclaims any and all warranties and liabilities of any kind, including without limitation warranties of non-infringement of intellectual property rights of any third party.

In addition, any information given in this document is subject to customer's compliance with its obligations stated in this document and any applicable legal requirements, norms and standards concerning customer's products and any use of the product of Infineon Technologies in customer's applications.

The data contained in this document is exclusively intended for technically trained staff. It is the responsibility of customer's technical departments to evaluate the suitability of the product for the intended application and the completeness of the product information given in this document with respect to such application.

For further information on the product, technology, delivery terms and conditions and prices please contact your nearest Infineon Technologies office (www.infineon.com).

WARNINGS

Due to technical requirements products may contain dangerous substances. For information on the types in question please contact your nearest Infineon Technologies office.

Except as otherwise explicitly approved by Infineon Technologies in a written document signed by authorized representatives of Infineon Technologies, Infineon Technologies' products may not be used in any applications where a failure of the product or any consequences of the use thereof can reasonably be expected to result in personal injury.