

# IRF7606PbF

HEXFET® Power MOSFET

- Generation V Technology
- Ultra Low On-Resistance
- P-Channel MOSFET
- Very Small SOIC Package
- Low Profile (<1.1mm)
- Available in Tape & Reel
- Fast Switching
- Lead-Free

## Description

Fifth Generation HEXFETs from International Rectifier utilize advanced processing techniques to achieve extremely low on-resistance per silicon area. This benefit, combined with the fast switching speed and ruggedized device design that HEXFET Power MOSFETs are well known for, provides the designer with an extremely efficient and reliable device for use in a wide variety of applications.

The new Micro8 package, with half the footprint area of the standard SO-8, provides the smallest footprint available in an SOIC outline. This makes the Micro8 an ideal device for applications where printed circuit board space is at a premium. The low profile (<1.1mm) of the Micro8 will allow it to fit easily into extremely thin application environments such as portable electronics and PCMCIA cards.

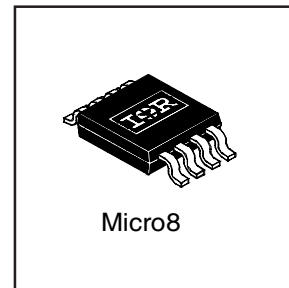
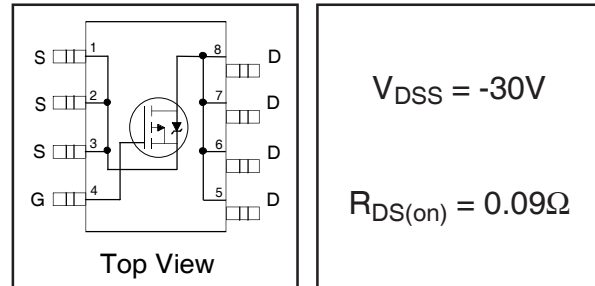

## Absolute Maximum Ratings

	Parameter	Max.	Units
$V_{DS}$	Drain-Source Voltage	-30	V
$I_D @ T_A = 25^\circ C$	Continuous Drain Current, $V_{GS} @ -10V$	-3.6	A
$I_D @ T_A = 70^\circ C$	Continuous Drain Current, $V_{GS} @ -10V$	-2.9	
$I_{DM}$	Pulsed Drain Current <sup>①</sup>	-29	
$P_D @ T_A = 25^\circ C$	Maximum Power Dissipation <sup>④</sup>	1.8	W
$P_D @ T_A = 70^\circ C$	Maximum Power Dissipation <sup>④</sup>	1.1	W
	Linear Derating Factor	14	mW/°C
$V_{GS}$	Gate-to-Source Voltage	$\pm 20$	V
$V_{GSM}$	Gate-to-Source Voltage Single Pulse $t_p < 10\mu S$	30	V
$dv/dt$	Peak Diode Recovery $dv/dt$ <sup>②</sup>	-5.0	V/ns
$T_J, T_{STG}$	Junction and Storage Temperature Range	-55 to + 150	°C
	Soldering Temperature, for 10 seconds	240 (1.6mm from case)	

## Thermal Resistance

	Parameter	Max.	Units
$R_{\theta JA}$	Maximum Junction-to-Ambient <sup>④</sup>	70	°C/W

All Micro8 Data Sheets reflect improved Thermal Resistance, Power and Current -Handling Ratings- effective only for product marked with Date Code 505 or later .

## Electrical Characteristics @ T<sub>J</sub> = 25°C (unless otherwise specified)

	Parameter	Min.	Typ.	Max.	Units	Conditions
V <sub>(BR)DSS</sub>	Drain-to-Source Breakdown Voltage	-30	—	—	V	V <sub>GS</sub> = 0V, I <sub>D</sub> = 250μA
ΔV <sub>(BR)DSS/ΔT<sub>J</sub></sub>	Breakdown Voltage Temp. Coefficient	—	-0.024	—	V/°C	Reference to 25°C, I <sub>D</sub> = -1mA
R <sub>DSON</sub>	Static Drain-to-Source On-Resistance	—	0.075	0.09	Ω	V <sub>GS</sub> = -10V, I <sub>D</sub> = -2.4A ③
		—	0.130	0.15		V <sub>GS</sub> = -4.5V, I <sub>D</sub> = -1.2A ③
V <sub>GS(th)</sub>	Gate Threshold Voltage	-1.0	—	—	V	V <sub>DS</sub> = V <sub>GS</sub> , I <sub>D</sub> = -250μA
g <sub>fs</sub>	Forward Transconductance	2.3	—	—	S	V <sub>DS</sub> = -10V, I <sub>D</sub> = -1.2A
I <sub>DSS</sub>	Drain-to-Source Leakage Current	—	—	-1.0	μA	V <sub>DS</sub> = -24V, V <sub>GS</sub> = 0V
		—	—	-25		V <sub>DS</sub> = -24V, V <sub>GS</sub> = 0V, T <sub>J</sub> = 125°C
I <sub>GSS</sub>	Gate-to-Source Forward Leakage	—	—	-100	nA	V <sub>GS</sub> = -20V
	Gate-to-Source Reverse Leakage	—	—	100		V <sub>GS</sub> = 20V
Q <sub>g</sub>	Total Gate Charge	—	20	30	nC	I <sub>D</sub> = -2.4A
Q <sub>gs</sub>	Gate-to-Source Charge	—	2.1	3.1		V <sub>DS</sub> = -24V
Q <sub>gd</sub>	Gate-to-Drain ("Miller") Charge	—	7.6	11		V <sub>GS</sub> = -10V, See Fig. 9 ③
t <sub>d(on)</sub>	Turn-On Delay Time	—	13	—	ns	V <sub>DD</sub> = -10V
t <sub>r</sub>	Rise Time	—	20	—		I <sub>D</sub> = -2.4A
t <sub>d(off)</sub>	Turn-Off Delay Time	—	43	—		R <sub>G</sub> = 6.0Ω
t <sub>f</sub>	Fall Time	—	39	—		R <sub>D</sub> = 4.0Ω ③
C <sub>iss</sub>	Input Capacitance	—	520	—	pF	V <sub>GS</sub> = 0V
C <sub>oss</sub>	Output Capacitance	—	300	—		V <sub>DS</sub> = -25V
C <sub>rss</sub>	Reverse Transfer Capacitance	—	140	—		f = 1.0MHz, See Fig. 8

## Source-Drain Ratings and Characteristics

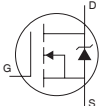
	Parameter	Min.	Typ.	Max.	Units	Conditions
I <sub>S</sub>	Continuous Source Current (Body Diode)	—	—	-1.8	A	MOSFET symbol showing the integral reverse p-n junction diode. 
I <sub>SM</sub>	Pulsed Source Current (Body Diode) ①	—	—	-29		
V <sub>SD</sub>	Diode Forward Voltage	—	—	-1.2	V	T <sub>J</sub> = 25°C, I <sub>S</sub> = -2.4A, V <sub>GS</sub> = 0V ③
t <sub>rr</sub>	Reverse Recovery Time	—	43	64	ns	T <sub>J</sub> = 25°C, I <sub>F</sub> = -2.4A
Q <sub>rr</sub>	Reverse Recovery Charge	—	50	76	nC	di/dt = -100A/μs ③

### Notes:

① Repetitive rating; pulse width limited by max. junction temperature. ( See fig. 10 )

③ Pulse width ≤ 300μs; duty cycle ≤ 2%.

② I<sub>SD</sub> ≤ -2.4A, di/dt ≤ -130A/μs, V<sub>DD</sub> ≤ V<sub>(BR)DSS</sub>, T<sub>J</sub> ≤ 150°C

④ Surface mounted on FR-4 board, t ≤ 10sec.

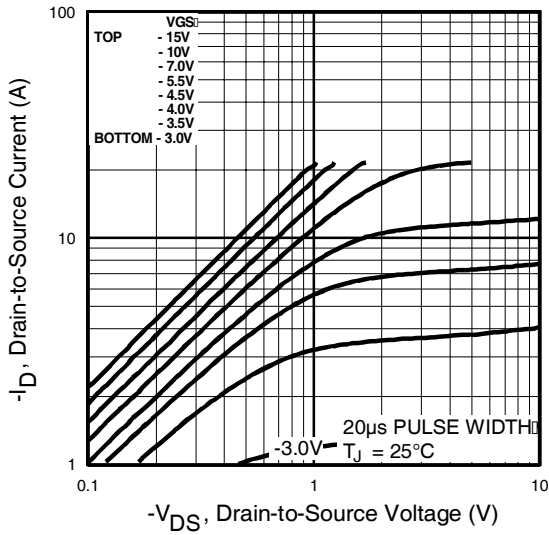

**Fig 1.** Typical Output Characteristics

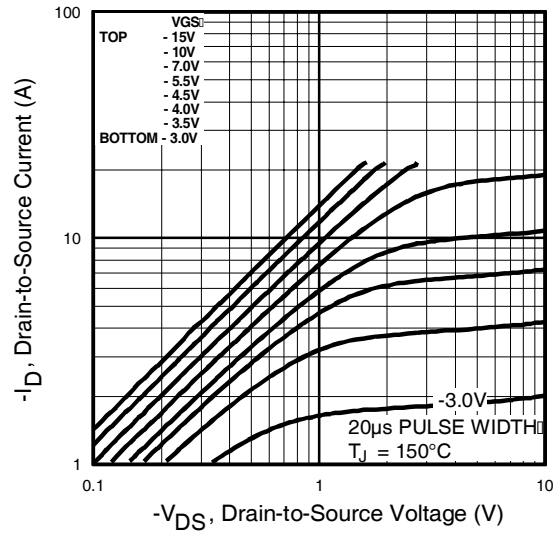

**Fig 2.** Typical Output Characteristics

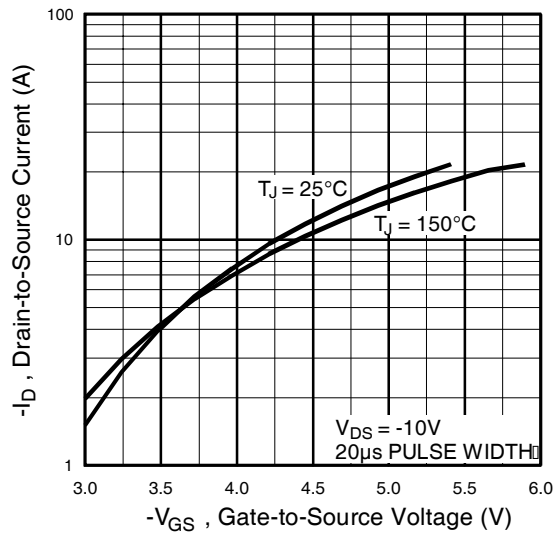

**Fig 3.** Typical Transfer Characteristics

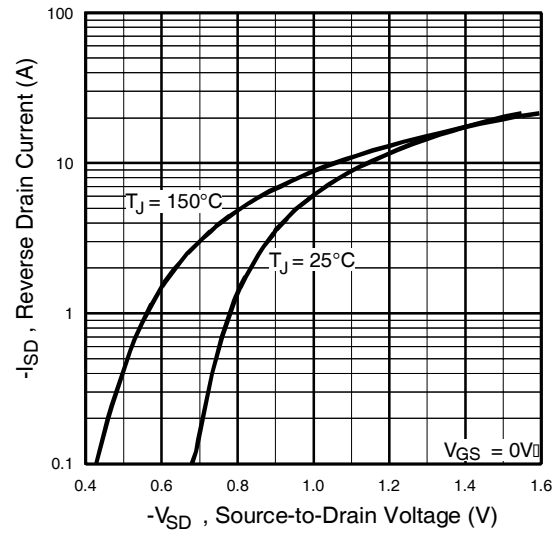

**Fig 4.** Typical Source-Drain Diode Forward Voltage

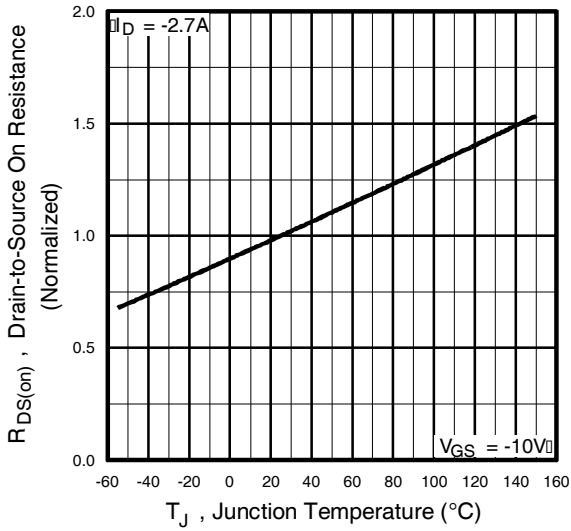

**Fig 5.** Normalized On-Resistance Vs. Temperature

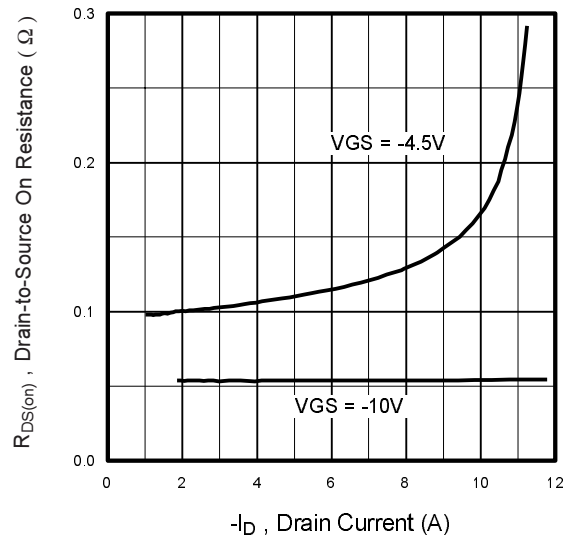

**Fig 6.** Typical On-Resistance Vs. Drain Current

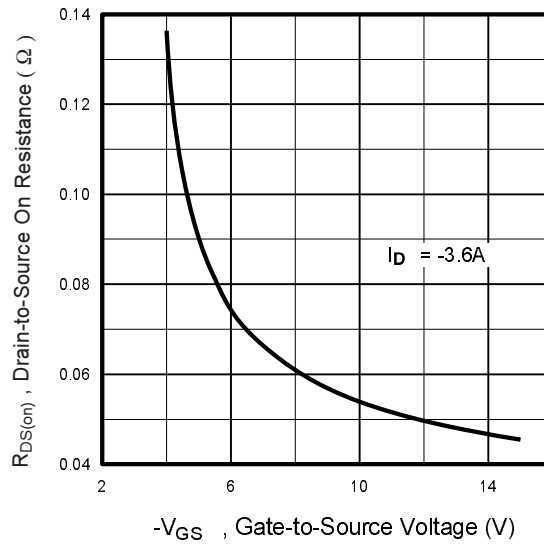

**Fig 7.** Typical On-Resistance Vs. Gate Voltage

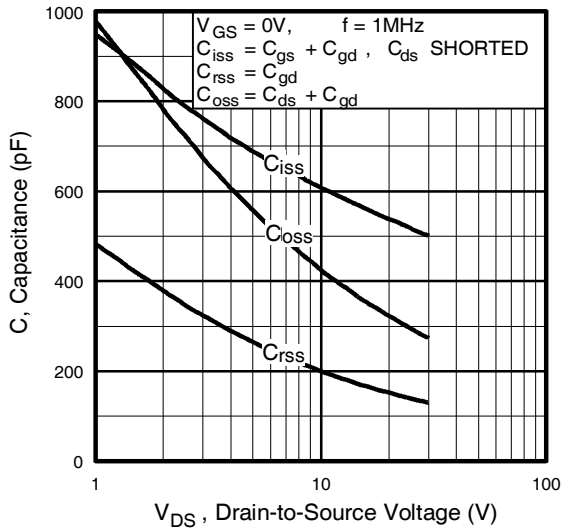

**Fig 8.** Typical Capacitance Vs. Drain-to-Source Voltage

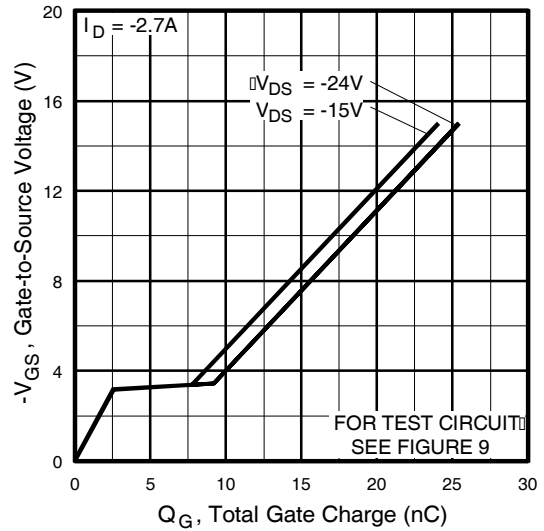

**Fig 9.** Typical Gate Charge Vs. Gate-to-Source Voltage

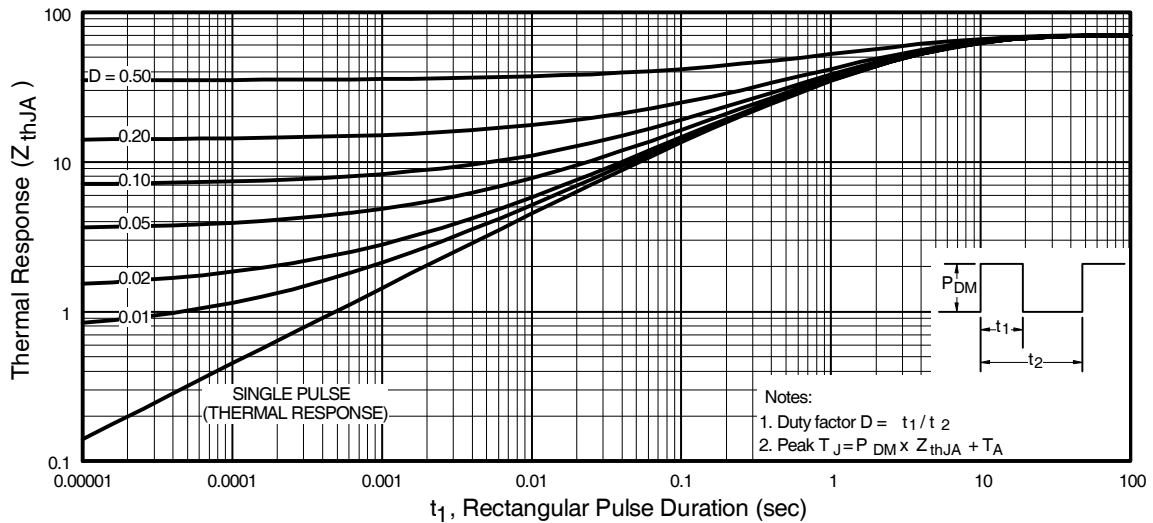

**Fig 10.** Maximum Effective Transient Thermal Impedance, Junction-to-Ambient

# IRF7606PbF

International  
**IR** Rectifier

## Micro8 Package Outline

Dimensions are shown in millimeters (inches)

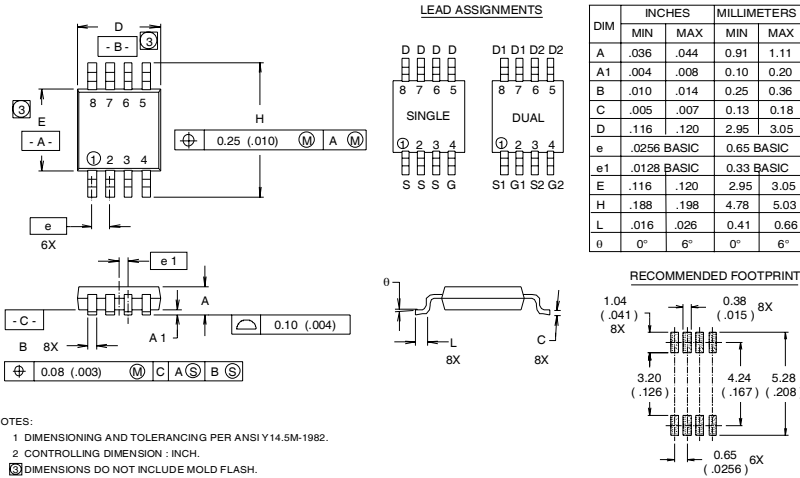

## Micro8 Part Marking Information

EXAMPLE: THIS IS AN IRF7501

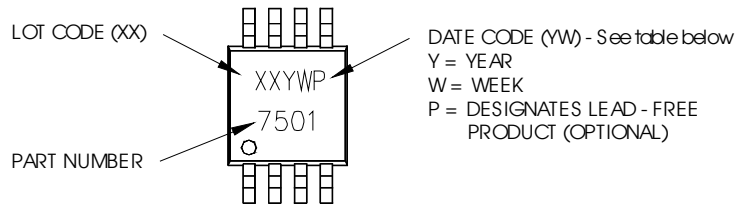

WW = (1-26) IF PRECEDED BY LAST DIGIT OF CALENDAR YEAR

YEAR	Y	WORK WEEK	W
2001	1	01	A
2002	2	02	B
2003	3	03	C
2004	4	04	D
2005	5		
2006	6		
2007	7		
2008	8		
2009	9		
2010	0	24	X
		25	Y
		26	Z

WW = (27-52) IF PRECEDED BY A LETTER

YEAR	Y	WORK WEEK	W
2001	A	27	A
2002	B	28	B
2003	C	29	C
2004	D	30	D
2005	E		
2006	F		
2007	G		
2008	H		
2009	J		
2010	K	50	X
		51	Y
		52	Z

## Micro8 Tape & Reel Information

Dimensions are shown in millimeters (inches)

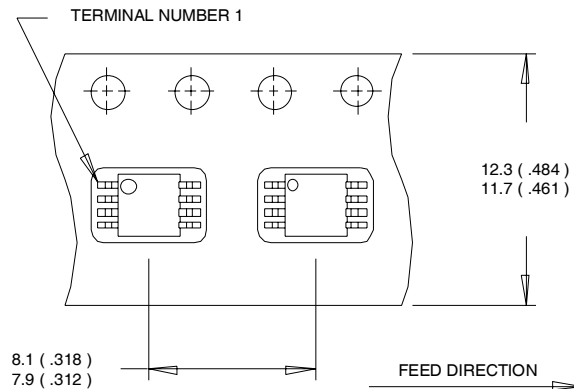

**NOTES:**

1. OUTLINE CONFORMS TO EIA-481 & EIA-541.
2. CONTROLLING DIMENSION : MILLIMETER.

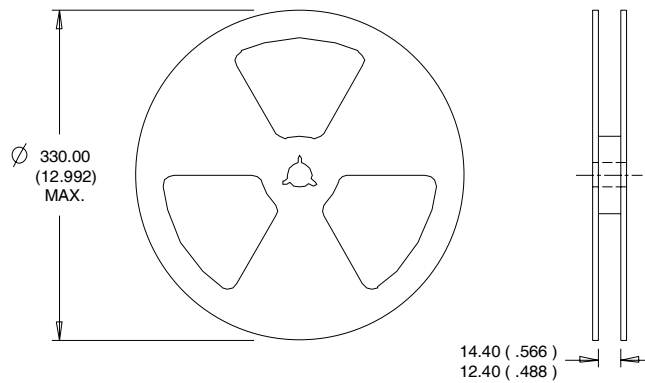

**NOTES:**

1. CONTROLLING DIMENSION : MILLIMETER.
2. OUTLINE CONFORMS TO EIA-481 & EIA-541.

Data and specifications subject to change without notice.  
 This product has been designed and qualified for the Consumer market.  
 Qualification Standards can be found on IR's Web site.