

- Advanced Process Technology
- Optimized for Industrial Motor Drive, DC-DC and other Heavy Load Applications
- Exceptionally Small Footprint and Low Profile
- High Power Density
- Low Parasitic Parameters
- Dual Sided Cooling
- Repetitive Avalanche Capability for Robustness and Reliability
- Lead Free, RoHS Compliant and Halogen Free

| | |
|--------------------------|--------------|
| $V_{(BR)DSS}$ | 40V |
| $R_{DS(on)}$ typ. | 1.5mΩ |
| | max. |
| I_D (Silicon Limited) | 156A |
| Q_g | 89nC |

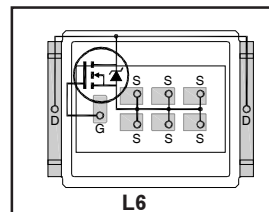

Applicable DirectFET® Outline and Substrate Outline ①

| | | | | | | | | | |
|-----------|-----------|--|-----------|-----------|--|-----------|-----------|-----------|--|
| SB | SC | | M2 | M4 | | L4 | L6 | L8 | |
|-----------|-----------|--|-----------|-----------|--|-----------|-----------|-----------|--|

Description

The IRF7737L2PbF combines the latest HEXFET® Power MOSFET Silicon technology with the advanced DirectFET® packaging technology to achieve exceptional performance in a package that has the footprint of a DPak (TO-252AA) and only 0.7 mm profile. The DirectFET® package is compatible with existing layout geometries used in power applications, PCB assembly equipment and vapor phase, infra-red or convection soldering techniques, when application note AN-1035 is followed regarding the manufacturing methods and processes. The DirectFET® package allows dual sided cooling to maximize thermal transfer.

This HEXFET® Power MOSFET is designed for applications where efficiency and power density are of value. The advanced DirectFET® packaging platform coupled with the latest silicon technology allows the IRF7737L2PbF to offer substantial system level savings and performance improvement specifically in motor drive, high frequency DC-DC and other heavy load applications. This MOSFET utilizes the latest processing techniques to achieve low on-resistance and low Q_g per silicon area. Additional features of this MOSFET are 175°C operating junction temperature and high repetitive peak current capability. These features combine to make this MOSFET a highly efficient, robust and reliable device for high current applications.

Absolute Maximum Ratings

Stresses beyond those listed under "Absolute Maximum Ratings" may cause permanent damage to the device. These are stress ratings only; and functional operation of the device at these or any other condition beyond those indicated in the specifications is not implied. Exposure to absolute-maximum-rated conditions for extended periods may affect device reliability. The thermal resistance and power dissipation ratings are measured under board mounted and still air conditions. Ambient temperature (T_A) is 25°C, unless otherwise specified.

| | Parameter | Max. | Units |
|---------------------------------|--|--------------------------|-------|
| V_{DS} | Drain-to-Source Voltage | 40 | V |
| V_{GS} | Gate-to-Source Voltage | ± 20 | |
| $I_D @ T_C = 25^\circ\text{C}$ | Continuous Drain Current, $V_{GS} @ 10\text{V}$ (Silicon Limited)④ | 156 | A |
| $I_D @ T_C = 100^\circ\text{C}$ | Continuous Drain Current, $V_{GS} @ 10\text{V}$ (Silicon Limited)④ | 110 | |
| $I_D @ T_A = 25^\circ\text{C}$ | Continuous Drain Current, $V_{GS} @ 10\text{V}$ (Silicon Limited)③ | 31 | |
| $I_D @ T_C = 25^\circ\text{C}$ | Continuous Drain Current, $V_{GS} @ 10\text{V}$ (Package Limited) | 315 | |
| I_{DM} | Pulsed Drain Current ⑤ | 624 | |
| $P_D @ T_C = 25^\circ\text{C}$ | Power Dissipation ④ | 83 | W |
| $P_D @ T_A = 25^\circ\text{C}$ | Power Dissipation ③ | 3.3 | |
| E_{AS} | Single Pulse Avalanche Energy (Thermally Limited) ⑥ | 104 | mJ |
| E_{AS} (tested) | Single Pulse Avalanche Energy Tested Value ⑥ | 386 | |
| I_{AR} | Avalanche Current ⑦ | See Fig.18a, 18b, 16, 17 | A |
| E_{AR} | Repetitive Avalanche Energy ⑧ | | mJ |
| T_P | Peak Soldering Temperature | 270 | °C |
| T_J | Operating Junction and | -55 to + 175 | |
| T_{STG} | Storage Temperature Range | | |

Thermal Resistance

| | Parameter | Typ. | Max. | Units |
|--------------------|--------------------------|------|------|-------|
| $R_{\theta JA}$ | Junction-to-Ambient ③ | — | 45 | °C/W |
| $R_{\theta JA}$ | Junction-to-Ambient ④ | 12.5 | — | |
| $R_{\theta JA}$ | Junction-to-Ambient ⑤ | 20 | — | |
| $R_{\theta JCan}$ | Junction-to-Can ④⑩ | — | 1.8 | |
| $R_{\theta J-PCB}$ | Junction-to-PCB Mounted | — | 0.5 | |
| | Linear Derating Factor ④ | 0.56 | | W/°C |

HEXFET® is a registered trademark of International Rectifier.

Static Characteristics @ $T_J = 25^\circ\text{C}$ (unless otherwise stated)

| | Parameter | Min. | Typ. | Max. | Units | Conditions |
|---------------------------------|--------------------------------------|------|------|------|----------------------|--|
| $V_{(BR)DSS}$ | Drain-to-Source Breakdown Voltage | 40 | — | — | V | $V_{GS} = 0V, I_D = 250\mu A$ |
| $\Delta V_{(BR)DSS}/\Delta T_J$ | Breakdown Voltage Temp. Coefficient | — | 0.03 | — | V/ $^\circ\text{C}$ | Reference to $25^\circ\text{C}, I_D = 1\text{mA}$ |
| $R_{DS(on)}$ | Static Drain-to-Source On-Resistance | — | 1.5 | 1.9 | m Ω | $V_{GS} = 10V, I_D = 94A$ ⑦ |
| $V_{GS(th)}$ | Gate Threshold Voltage | 2.0 | 3.0 | 4.0 | V | $V_{DS} = V_{GS}, I_D = 150\mu A$ |
| $\Delta V_{GS(th)}/\Delta T_J$ | Gate Threshold Voltage Coefficient | — | -10 | — | mV/ $^\circ\text{C}$ | |
| g_{fs} | Forward Transconductance | 100 | — | — | S | $V_{DS} = 10V, I_D = 94A$ |
| R_G | Gate Resistance | — | 0.6 | — | Ω | |
| I_{DSS} | Drain-to-Source Leakage Current | — | — | 5 | μA | $V_{DS} = 40V, V_{GS} = 0V$ |
| | | — | — | 250 | | $V_{DS} = 40V, V_{GS} = 0V, T_J = 125^\circ\text{C}$ |
| I_{GSS} | Gate-to-Source Forward Leakage | — | — | 100 | nA | $V_{GS} = 20V$ |
| | Gate-to-Source Reverse Leakage | — | — | -100 | | $V_{GS} = -20V$ |

Dynamic Characteristics @ $T_J = 25^\circ\text{C}$ (unless otherwise stated)

| | Parameter | Min. | Typ. | Max. | Units | Conditions |
|-----------------|--|------|------|------|-------|--|
| Q_g | Total Gate Charge | — | 89 | 134 | nC | $V_{DS} = 20V, V_{GS} = 10V$ $I_D = 94A$ See Fig. 11 |
| Q_{gs1} | Pre-V _{th} Gate-to-Source Charge | — | 18 | — | | |
| Q_{gs2} | Post-V _{th} Gate-to-Source Charge | — | 8 | — | | |
| Q_{gd} | Gate-to-Drain ("Miller") Charge | — | 34 | — | | |
| Q_{godr} | Gate Charge Overdrive | — | 29 | — | | |
| Q_{sw} | Switch Charge ($Q_{gs2} + Q_{gd}$) | — | 42 | — | nC | $V_{DS} = 16V, V_{GS} = 0V$ |
| Q_{oss} | Output Charge | — | 39 | — | nC | $V_{DD} = 20V, V_{GS} = 10V$ ⑧ $I_D = 94A$ $R_G = 1.8\Omega$ |
| $t_{d(on)}$ | Turn-On Delay Time | — | 12 | — | ns | $V_{GS} = 0V$ $V_{DS} = 25V$ $f = 1.0\text{MHz}$ |
| t_r | Rise Time | — | 19 | — | | |
| $t_{d(off)}$ | Turn-Off Delay Time | — | 22 | — | | |
| t_f | Fall Time | — | 14 | — | | |
| C_{iss} | Input Capacitance | — | 5469 | — | pF | $V_{GS} = 0V, V_{DS} = 1.0V, f = 1.0\text{MHz}$ $V_{GS} = 0V, V_{DS} = 32V, f = 1.0\text{MHz}$ $V_{GS} = 0V, V_{DS} = 0V$ to $32V$ |
| C_{oss} | Output Capacitance | — | 1193 | — | | |
| C_{rss} | Reverse Transfer Capacitance | — | 534 | — | | |
| C_{oss} | Output Capacitance | — | 4296 | — | | |
| C_{oss} | Output Capacitance | — | 1066 | — | | |
| $C_{oss\ eff.}$ | Effective Output Capacitance | — | 1615 | — | | |

Diode Characteristics @ $T_J = 25^\circ\text{C}$ (unless otherwise stated)

| | Parameter | Min. | Typ. | Max. | Units | Conditions |
|----------|---|------|------|------|-------|--|
| I_S | Continuous Source Current (Body Diode) | — | — | 156 | A | MOSFET symbol showing the integral reverse p-n junction diode.  |
| I_{SM} | Pulsed Source Current (Body Diode) ⑤ | — | — | 624 | | |
| V_{SD} | Diode Forward Voltage | — | — | 1.3 | V | $I_S = 94A, V_{GS} = 0V$ ⑥ |
| t_{rr} | Reverse Recovery Time | — | 35 | 53 | ns | $I_F = 94A, V_{DD} = 20V$ |
| Q_{rr} | Reverse Recovery Charge | — | 32 | 48 | nC | $di/dt = 100A/\mu s$ ⑥ |

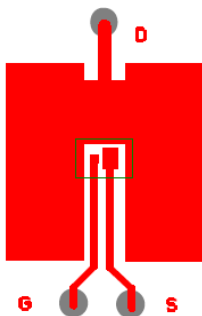

③ Surface mounted on 1 in. square Cu (still air).

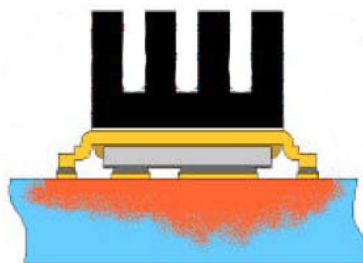

④ Mounted to a PCB with small clip heatsink (still air)

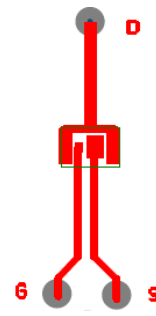

⑤ Mounted on minimum footprint full size board with metalized back and with small clip heatsink (still air)

Notes ① through ⑩ are on page 10

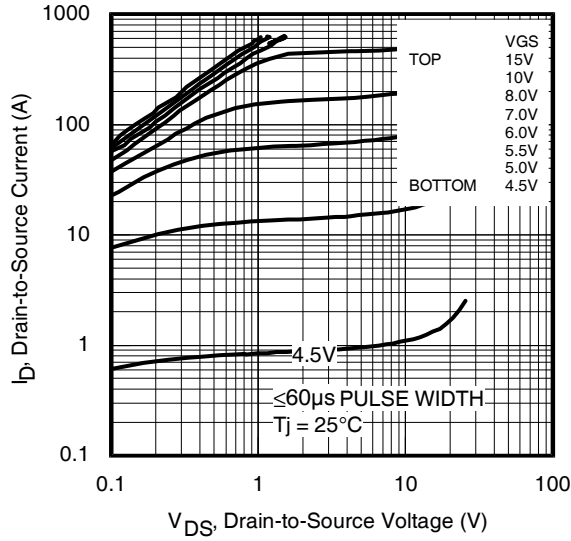

Fig 1. Typical Output Characteristics

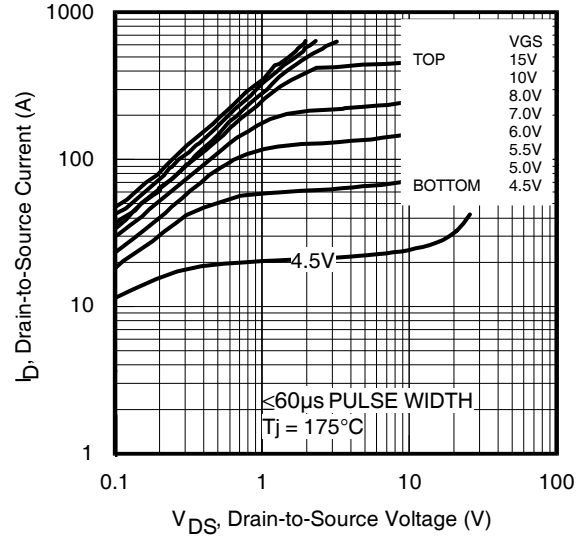

Fig 2. Typical Output Characteristics

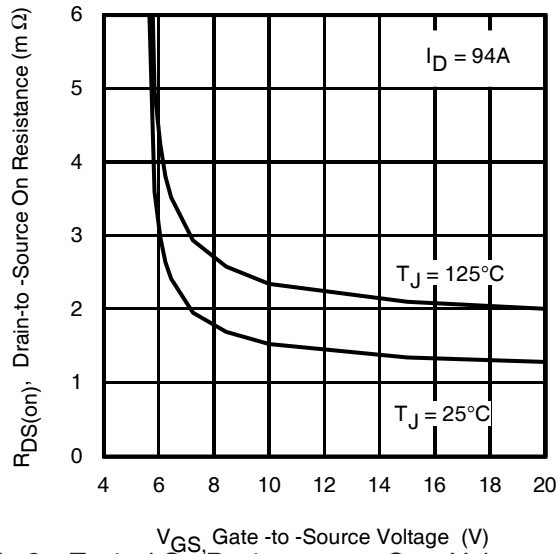

Fig 3. Typical On-Resistance vs. Gate Voltage

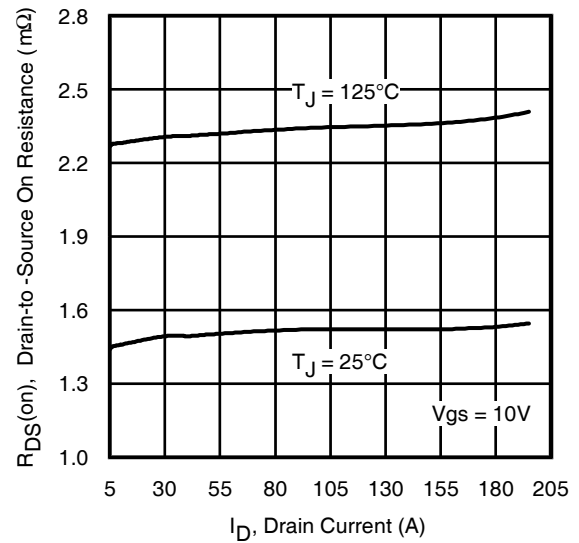

Fig 4. Typical On-Resistance vs. Drain Current

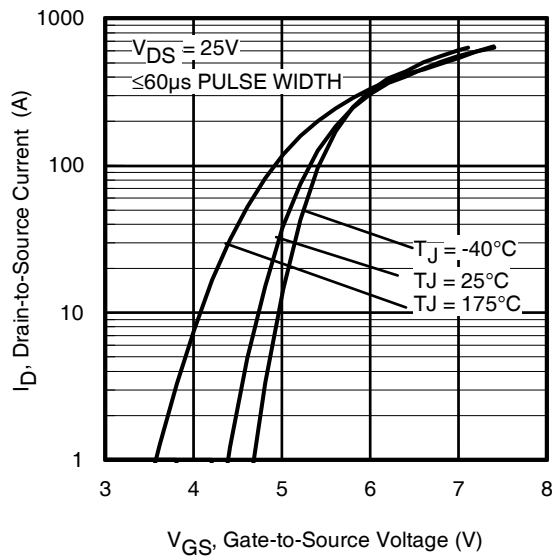

Fig 5. Typical Transfer Characteristics

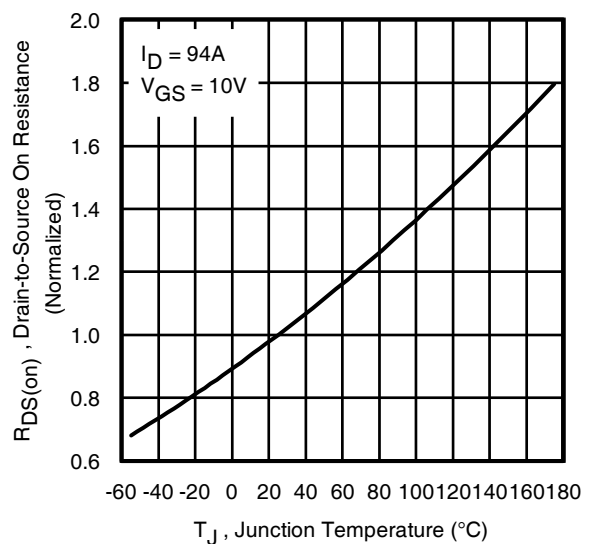

Fig 6. Normalized On-Resistance vs. Temperature

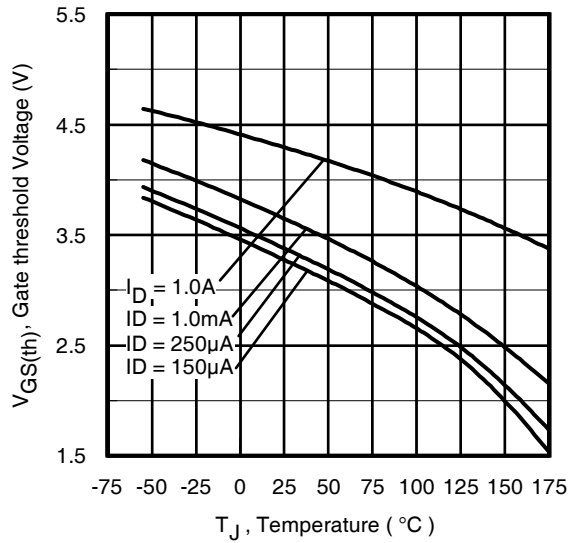

Fig 7. Typical Threshold Voltage vs. Junction Temperature

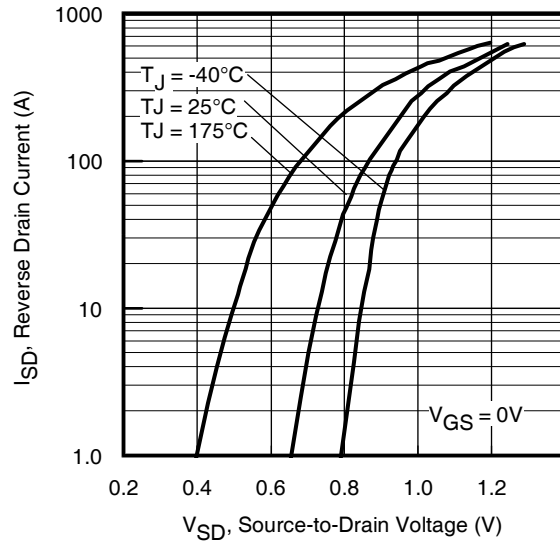

Fig 8. Typical Source-Drain Diode Forward Voltage

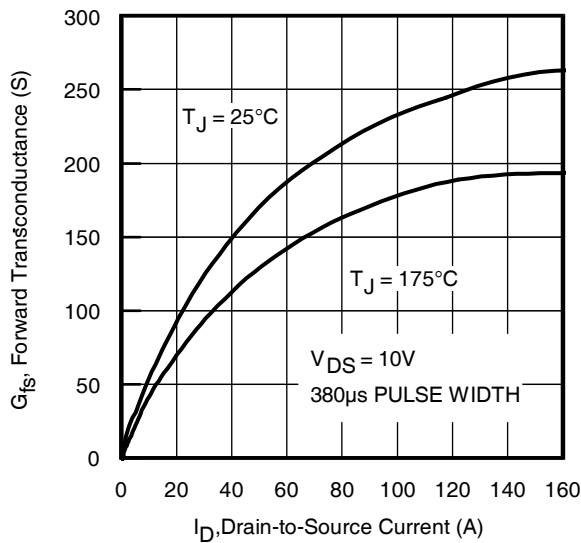

Fig 9. Typical Forward Transconductance Vs. Drain Current

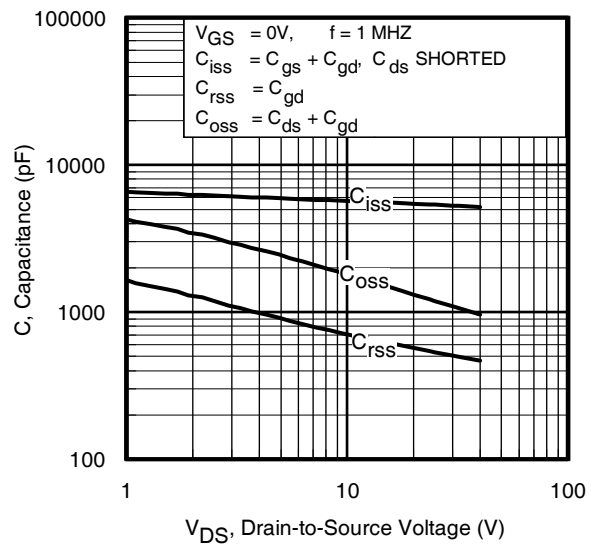

Fig 10. Typical Capacitance vs. Drain-to-Source Voltage

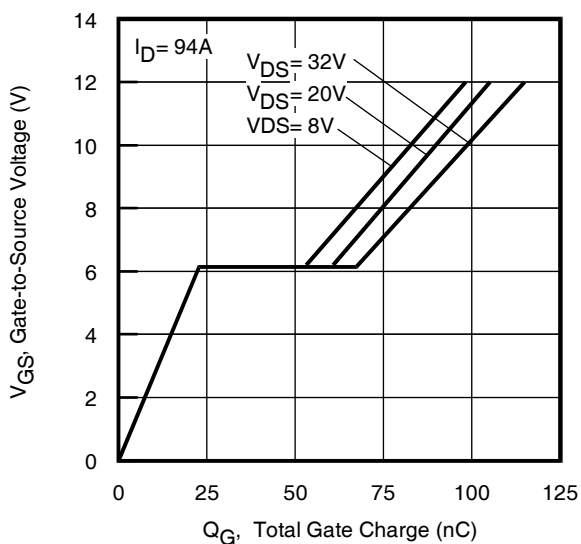

Fig.11 Typical Gate Charge vs. Gate-to-Source Voltage

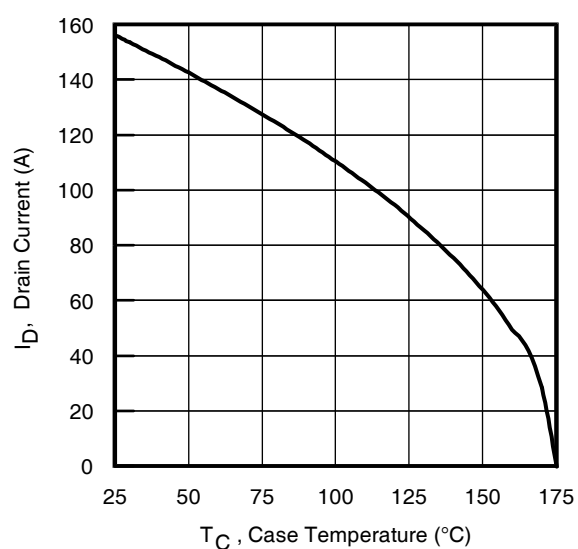

Fig 12. Maximum Drain Current vs. Case Temperature

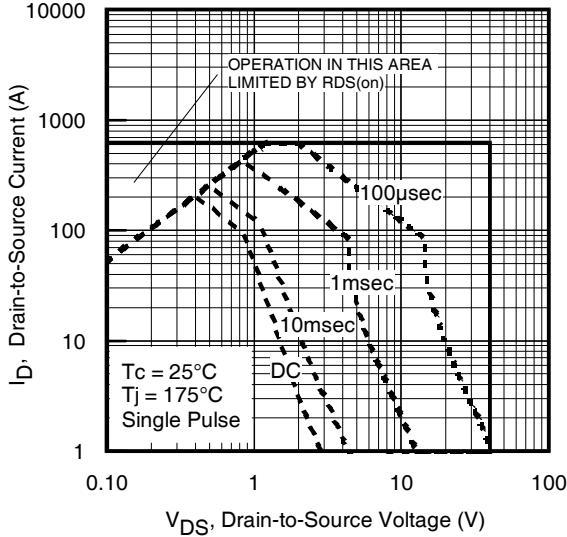

Fig 13. Maximum Safe Operating Area

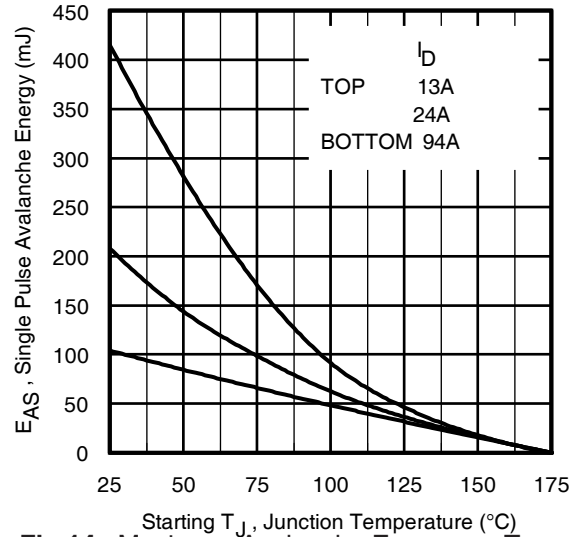

Fig 14. Maximum Avalanche Energy vs. Temperature

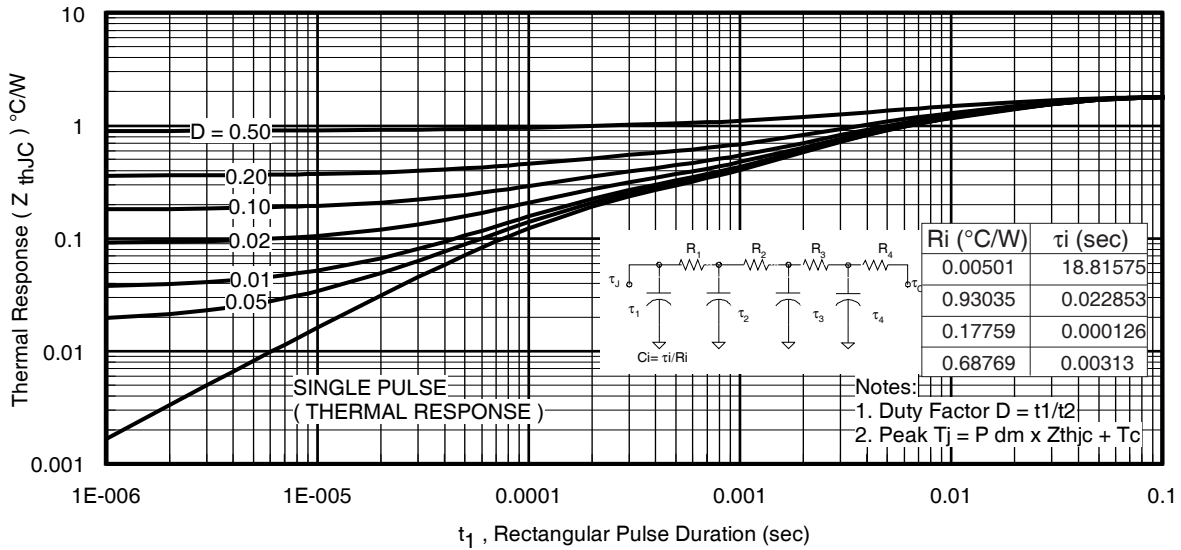

Fig 15. Maximum Effective Transient Thermal Impedance, Junction-to-Case

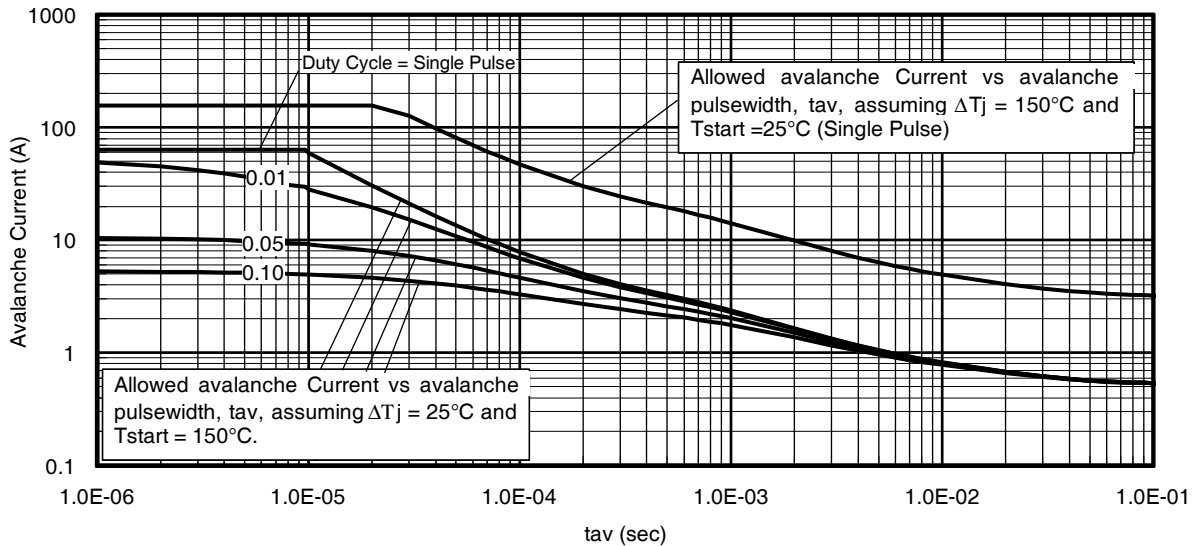

Fig 16. Typical Avalanche Current Vs. Pulsewidth

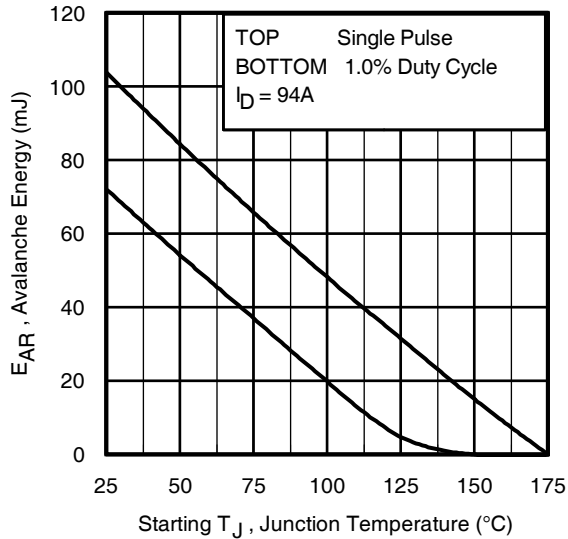

Fig 17. Maximum Avalanche Energy Vs. Temperature

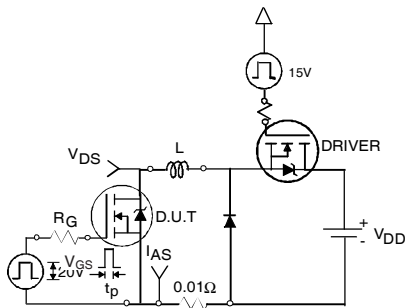

Fig 18a. Unclamped Inductive Test Circuit

Notes on Repetitive Avalanche Curves , Figures 16, 17:
(For further info, see AN-1005 at www.irf.com)

1. Avalanche failures assumption:
Purely a thermal phenomenon and failure occurs at a temperature far in excess of T_{jmax} . This is validated for every part type.
2. Safe operation in Avalanche is allowed as long as T_{jmax} is not exceeded.
3. Equation below based on circuit and waveforms shown in Figures 18a, 18b.
4. $P_{D(ave)}$ = Average power dissipation per single avalanche pulse.
5. BV = Rated breakdown voltage (1.3 factor accounts for voltage increase during avalanche).
6. I_{av} = Allowable avalanche current.
7. ΔT = Allowable rise in junction temperature, not to exceed T_{jmax} (assumed as 25°C in Figure 16, 17).
 t_{av} = Average time in avalanche.
 D = Duty cycle in avalanche = $t_{av} \cdot f$
 $Z_{thJC}(D, t_{av})$ = Transient thermal resistance, see figure 15)

$$P_{D(ave)} = 1/2 (1.3 \cdot BV \cdot I_{av}) = \Delta T / Z_{thJC}$$

$$I_{av} = 2\Delta T / [1.3 \cdot BV \cdot Z_{th}]$$

$$E_{AS(AR)} = P_{D(ave)} \cdot t_{av}$$

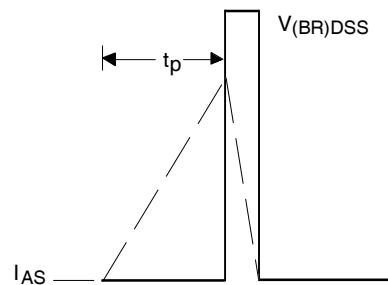

Fig 18b. Unclamped Inductive Waveforms

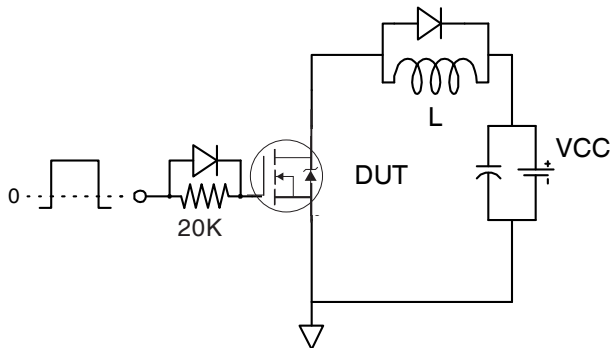

Fig 19a. Gate Charge Test Circuit

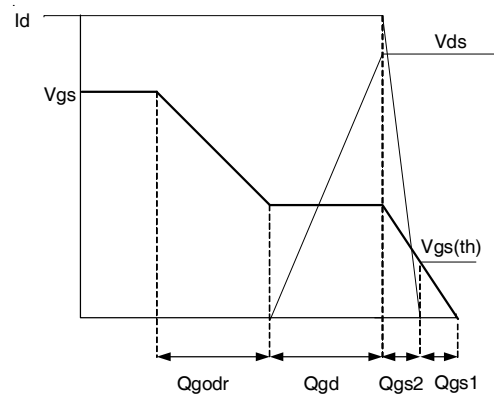

Fig 19b. Gate Charge Waveform

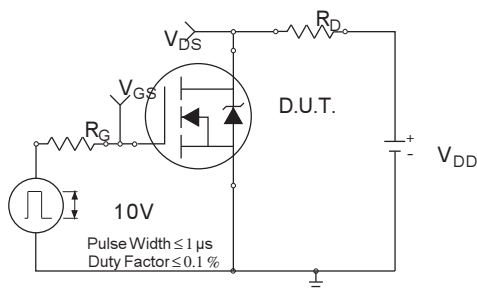

Fig 20a. Switching Time Test Circuit

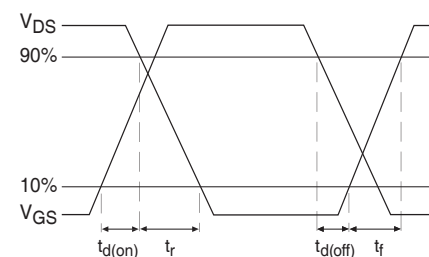
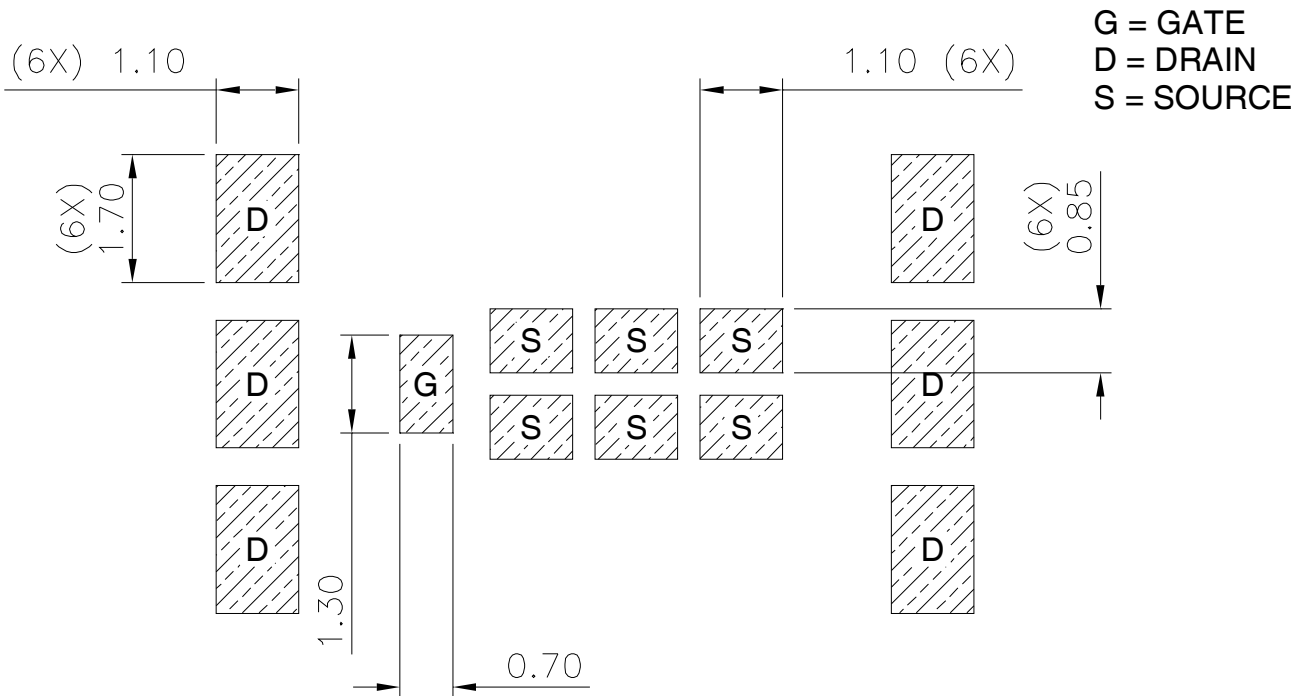
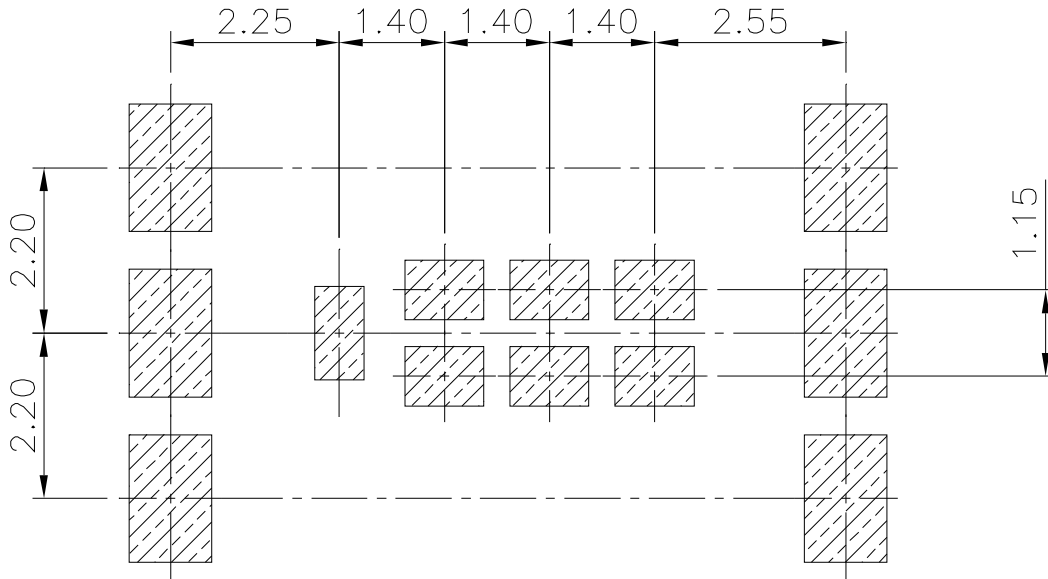

Fig 20b. Switching Time Waveforms

DirectFET® Board Footprint, L6 (Large Size Can).

Please see AN-1035 for DirectFET® assembly details and stencil and substrate design recommendations



DirectFET™ Outline Dimension, L6 Outline (LargeSize Can).

Please see AN-1035 for DirectFET assembly details and stencil and substrate design recommendations

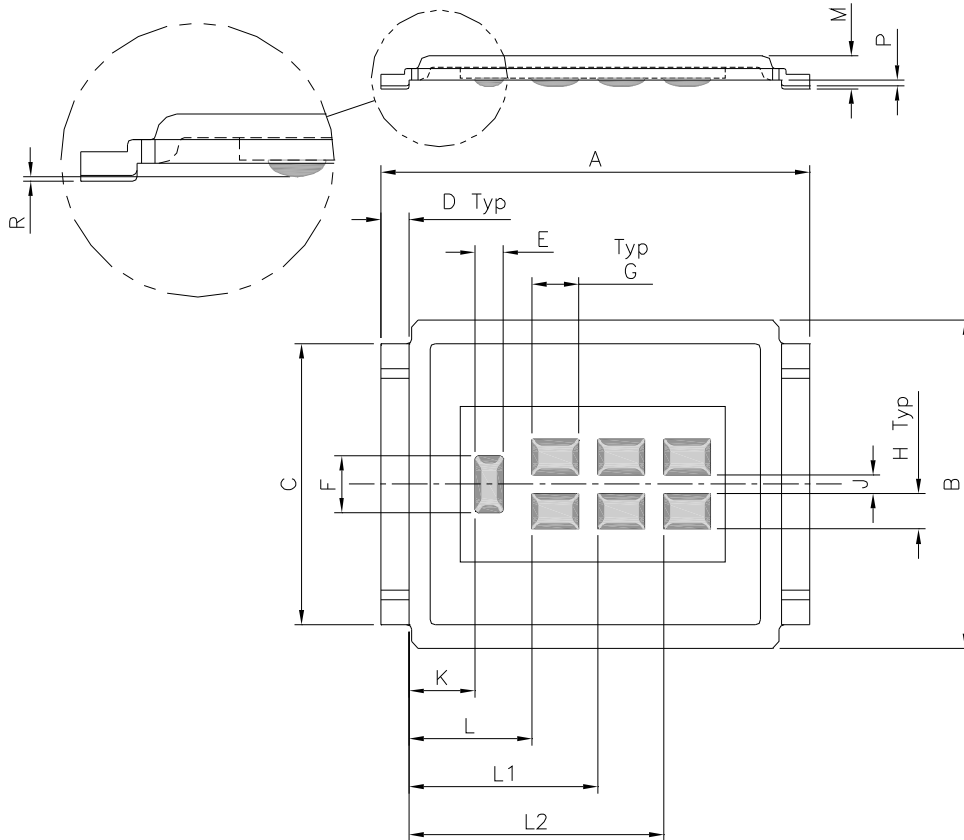

| CODE | METRIC | | IMPERIAL | |
|------|--------|------|----------|-------|
| | MIN | MAX | MIN | MAX |
| A | 9.05 | 9.15 | 0.356 | 0.360 |
| B | 6.85 | 7.10 | 0.270 | 0.280 |
| C | 5.90 | 6.00 | 0.232 | 0.236 |
| D | 0.55 | 0.65 | 0.022 | 0.026 |
| E | 0.58 | 0.62 | 0.023 | 0.024 |
| F | 1.18 | 1.22 | 0.046 | 0.048 |
| G | 0.98 | 1.02 | 0.039 | 0.040 |
| H | 0.73 | 0.77 | 0.029 | 0.030 |
| J | 0.38 | 0.42 | 0.015 | 0.017 |
| K | 1.35 | 1.45 | 0.053 | 0.057 |
| L | 2.55 | 2.65 | 0.100 | 0.104 |
| L1 | 3.95 | 4.05 | 0.155 | 0.159 |
| L2 | 5.35 | 5.45 | 0.210 | 0.214 |
| M | 0.68 | 0.74 | 0.027 | 0.029 |
| P | 0.09 | 0.17 | 0.003 | 0.007 |
| R | 0.02 | 0.08 | 0.001 | 0.003 |

DirectFET™ Part Marking

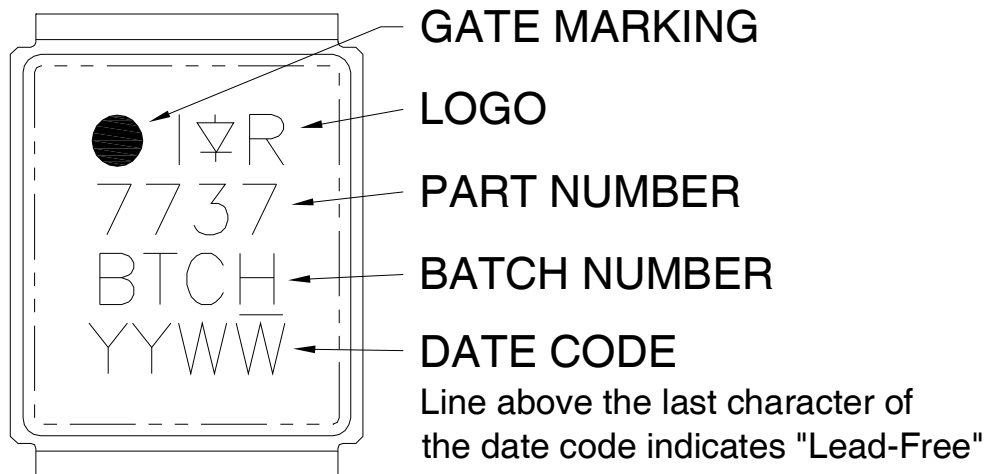

Note: For the most current drawing please refer to IR website at <http://www.irf.com/package/>

DirectFET® Tape & Reel Dimension (Showing component orientation).

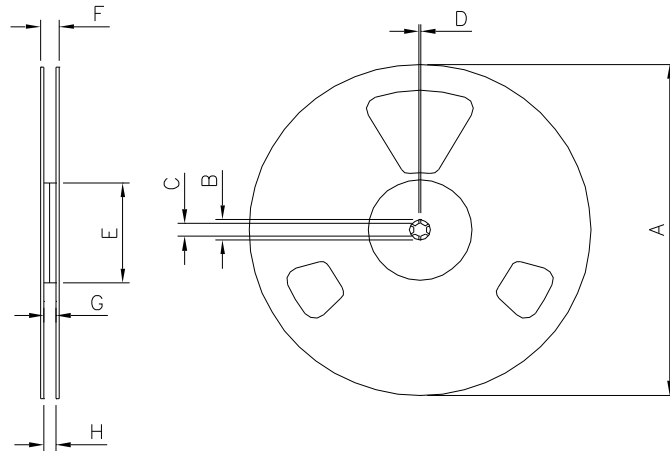

NOTE: Controlling dimensions in mm
 Std reel quantity is 4000 parts. (ordered as IRF7737L2TR). For 1000 parts on 7" reel, order IRF7737L2TR1

| REEL DIMENSIONS | | | | | | | | |
|-----------------|----------------------------|--------|----------|-------|-----------------------|-------|----------|------|
| CODE | STANDARD OPTION (QTY 4000) | | | | TR1 OPTION (QTY 1000) | | | |
| | METRIC | | IMPERIAL | | METRIC | | IMPERIAL | |
| A | 330.00 | N.C | 12.992 | N.C | 177.80 | N.C | 7.000 | N.C |
| B | 20.20 | N.C | 0.795 | N.C | 20.20 | N.C | 0.795 | N.C |
| C | 12.80 | 13.20 | 0.504 | 0.520 | 12.98 | 13.50 | 0.331 | 0.50 |
| D | 1.50 | N.C | 0.059 | N.C | 1.50 | 2.50 | 0.059 | N.C |
| E | 99.00 | 100.00 | 3.900 | 3.940 | 62.48 | N.C | 2.460 | N.C |
| F | N.C | 22.40 | N.C | 0.880 | N.C | N.C | N.C | 0.53 |
| G | 16.40 | 18.40 | 0.650 | 0.720 | N.C | N.C | N.C | N.C |
| H | 15.90 | 19.40 | 0.630 | 0.760 | 16.00 | N.C | 0.630 | N.C |

LOADED TAPE FEED DIRECTION

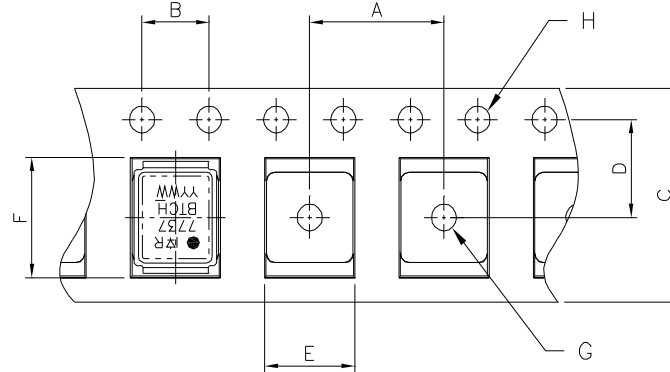
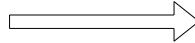

NOTE: CONTROLLING DIMENSIONS IN MM

| CODE | DIMENSIONS | | | |
|------|------------|-------|----------|-------|
| | METRIC | | IMPERIAL | |
| A | 11.90 | 12.10 | 4.69 | 0.476 |
| B | 3.90 | 4.10 | 0.154 | 0.161 |
| C | 15.90 | 16.30 | 0.623 | 0.642 |
| D | 7.40 | 7.60 | 0.291 | 0.299 |
| E | 7.20 | 7.40 | 0.283 | 0.291 |
| F | 9.90 | 10.10 | 0.390 | 0.398 |
| G | 1.50 | N.C | 0.059 | N.C |
| H | 1.50 | 1.60 | 0.059 | 0.063 |

Note: For the most current drawing please refer to IR website at <http://www.irf.com/package/>
www.irf.com

| Part number | Package Type | Standard Pack | | Note |
|-----------------|----------------------|---------------|----------|--------------|
| | | Form | Quantity | |
| IRF7737L2TRPbF | DirectFET2 Large Can | Tape and Reel | 4000 | "TR" suffix |
| IRF7737L2TR1PbF | DirectFET2 Large Can | Tape and Reel | 1000 | "TR1" suffix |

Qualification Information[†]

| | | |
|----------------------------|--|--|
| Qualification level | Industrial ^{††} | |
| | (per JEDEC JESD47F ^{†††} guidelines) | |
| | Comments: This family of products has passed JEDEC's Industrial qualification. IR's Consumer qualification level is granted by extension of the higher Industrial level. | |
| Moisture Sensitivity Level | DFET2 | MSL1 (per JEDEC J-STD-020D ^{†††}) |
| RoHS Compliant | Yes | |

[†] Qualification standards can be found at International Rectifier's web site

<http://www.irf.com/product-info/reliability>

^{††} Higher qualification ratings may be available should the user have such requirements.

Please contact your International Rectifier sales representative for further information:

<http://www.irf.com/whoto-call/salesrep/>

^{†††} Applicable version of JEDEC standard at the time of product release.

Notes:

- ① Click on this section to link to the appropriate technical paper.
- ② Click on this section to link to the DirectFET® Website.
- ③ Surface mounted on 1 in. square Cu board, steady state.
- ④ T_C measured with thermocouple mounted to top (Drain) of part.
- ⑤ Repetitive rating; pulse width limited by max. junction temperature.
- ⑥ Starting $T_J = 25^\circ\text{C}$, $L = 0.024\text{mH}$, $R_G = 50\Omega$, $I_{AS} = 94\text{A}$.
- ⑦ Pulse width $\leq 400\mu\text{s}$; duty cycle $\leq 2\%$.
- ⑧ Used double sided cooling, mounting pad with large heatsink.
- ⑨ Mounted on minimum footprint full size board with metalized back and with small clip heatsink.
- ⑩ R_θ is measured at T_J of approximately 90°C .

Data and specifications subject to change without notice.

This product has been designed and qualified for the Industrial market.

Qualification Standards can be found on IR's Web site.

International
IR Rectifier

IR WORLD HEADQUARTERS: 101 N. Sepulveda Blvd. , El Segundo, California 90245, USA Tel: (310) 252-7105

TAC Fax: (310) 252-7903

Visit us at www.irf.com for sales contact information. 10/2011

www.irf.com