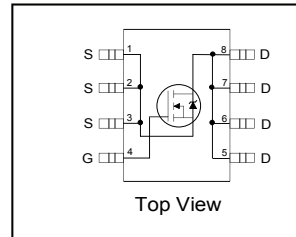

HEXFET® Chip-Set for DC-DC Converters

V_{DSS}	30	V
$R_{DS(on)}$ (@ $V_{GS} = 4.5V$)	11	mΩ
Q_g (typical)	22	nC
I_D (@ $T_A = 25^\circ C$)	13	A

Features

Industry-standard pinout SO-8 Package
Compatible with Existing Surface Mount Techniques
RoHS Compliant, Halogen-Free
MSL1, Industrial qualification

Benefits

Multi-Vendor Compatibility
Easier Manufacturing
Environmentally Friendlier
Increased Reliability

Base part number	Package Type	Standard Pack		Orderable Part Number
		Form	Quantity	
IRF7805PbF-1	SO-8	Tape and Reel	4000	IRF7805TRPbF-1

Symbol	Parameter	Max.	Units
V_{DS}	Drain-Source Voltage	30	V
V_{GS}	Gate-to-Source Voltage	± 12	
$I_D @ T_A = 25^\circ C$	Continuous Drain Current, $V_{GS} @ 10V$ ③	13	A
$I_D @ T_A = 70^\circ C$	Continuous Drain Current, $V_{GS} @ 10V$ ③	10	
I_{DM}	Pulsed Drain Current ①	100	
$P_D @ T_A = 25^\circ C$	Maximum Power Dissipation ③	2.5	W
$P_D @ T_A = 70^\circ C$	Maximum Power Dissipation ③	1.6	
	Linear Derating Factor	0.02	W/°C
T_J T_{STG}	Operating Junction and Storage Temperature Range	-55 to + 150	°C

Thermal Resistance

Symbol	Parameter	Typ.	Max.	Units
$R_{\theta JL}$	Junction-to-Drain Lead ⑤	—	20	°C/W
$R_{\theta JA}$	Junction-to-Ambient ③	—	50	

Static @ T_J = 25°C (unless otherwise specified)

	Parameter	Min.	Typ.	Max.	Units	Conditions
V _{(BR)DSS}	Drain-to-Source Breakdown Voltage ⑥	30	—	—	V	V _{GS} = 0V, I _D = 250μA
R _{DS(on)}	Static Drain-to-Source On-Resistance ⑥	—	9.2	11	mΩ	V _{GS} = 4.5V, I _D = 7.0A ②
V _{GS(th)}	Gate Threshold Voltage ⑥	1.0	—	3.0	V	V _{DS} = V _{GS} , I _D = 250μA
I _{DSS}	Drain-to-Source Leakage Current	—	—	70	μA	V _{DS} = 30V, V _{GS} = 0V
		—	—	10		V _{DS} = 24V, V _{GS} = 0V
		—	—	150		V _{DS} = 24V, V _{GS} = 0V, T _J = 100°C
I _{GSS}	Gate-to-Source Forward Leakage	—	—	100	nA	V _{GS} = 12V
	Gate-to-Source Reverse Leakage	—	—	-100		V _{GS} = -12V

Dynamic Electrical Characteristics @ T_J = 25°C (unless otherwise specified)

Q _g	Total Gate Charge ⑥	—	22	31	nC	V _{GS} = 5.0V V _{DS} = 16V I _D = 7.0A
Q _{gs1}	Pre -V _{th} Gate-to-Source Charge	—	3.7	—		
Q _{gs2}	Post-V _{th} Gate-to-Source Charge	—	1.4	—		
Q _{gd}	Gate-to-Drain Charge	—	6.8	—		
Q _{sw}	Switch Charge (Q _{gs2} + Q _{gd}) ⑥	—	8.2	11.5		
Q _{oss}	Output Charge ⑥	—	30	36	nC	V _{DS} = 16V, V _{GS} = 0V
R _G	Gate Resistance	0.5	—	1.7	Ω	
t _{d(on)}	Turn-On Delay Time	—	16	—	ns	V _{DD} = 16V, V _{GS} = 4.5V ② I _D = 7.0A R _G = 2Ω Resistive Load
t _r	Rise Time	—	20	—		
t _{d(off)}	Turn-Off Delay Time	—	38	—		
t _f	Fall Time	—	16	—		

Diode Characteristics

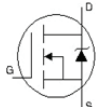
	Parameter	Min.	Typ.	Max.	Units	Conditions
I _S	Continuous Source Current (Body Diode)①	—	—	2.5	A	MOSFET symbol showing the integral reverse p-n junction diode. 
I _{SM}	Pulsed Source Current (Body Diode)	—	—	106		
V _{SD}	Diode Forward Voltage⑥	—	—	1.2	V	T _J = 25°C, I _S = 7.0A, V _{GS} = 0V
Q _{rr}	Reverse Recovery Charge ④	—	88	—	nC	di/dt = 700A/μs V _{DS} = 16V, V _{GS} = 0V, I _S = 7.0A
Q _{rr}	Reverse Recovery Charge ④	—	55	—		di/dt = 700A/μs (with 10BQ040) V _{DS} = 16V, V _{GS} = 0V, I _S = 7.0A

Notes:

- ① Repetitive rating; pulse width limited by max. junction temperature.
- ② Pulse width ≤ 300μs; duty cycle ≤ 2%.
- ③ When mounted on 1" in square copper board, t < 10 sec.
- ④ Typ = measured - Q_{oss}
- ⑤ R_θ is measured at T_J of approximately 90°C.
- ⑥ Devices are 100% tested to these parameters.

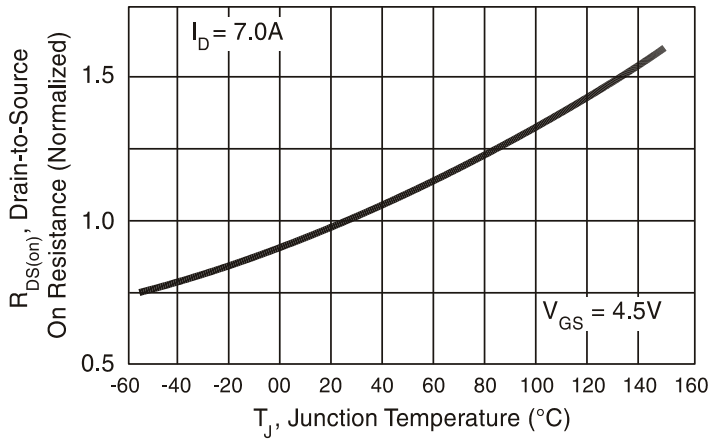
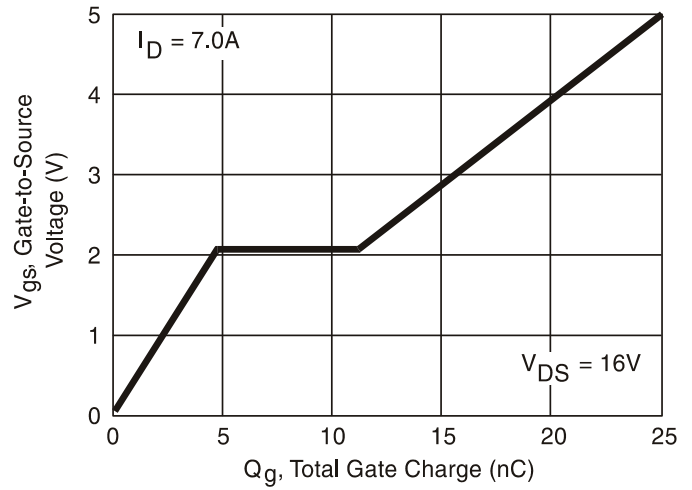
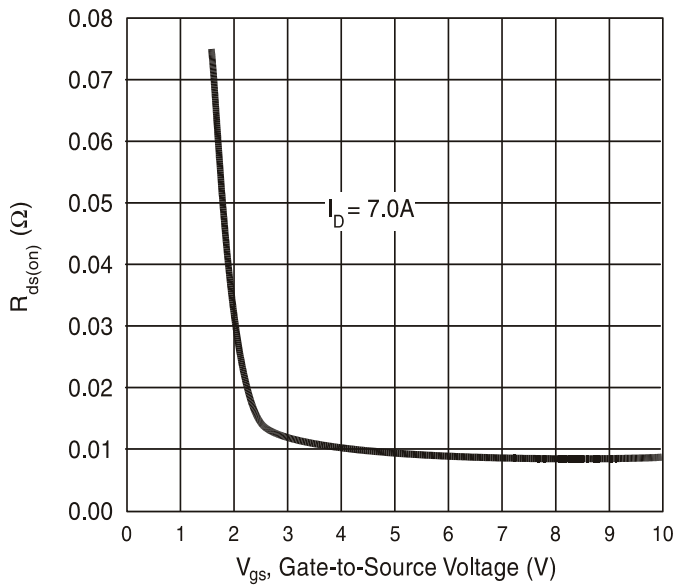
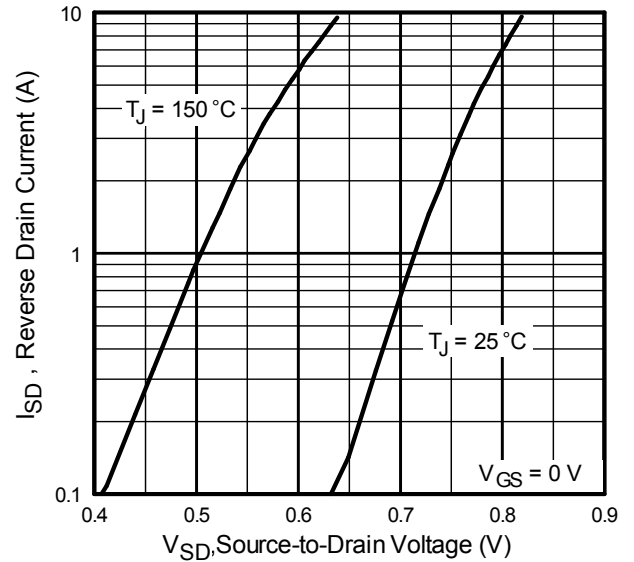
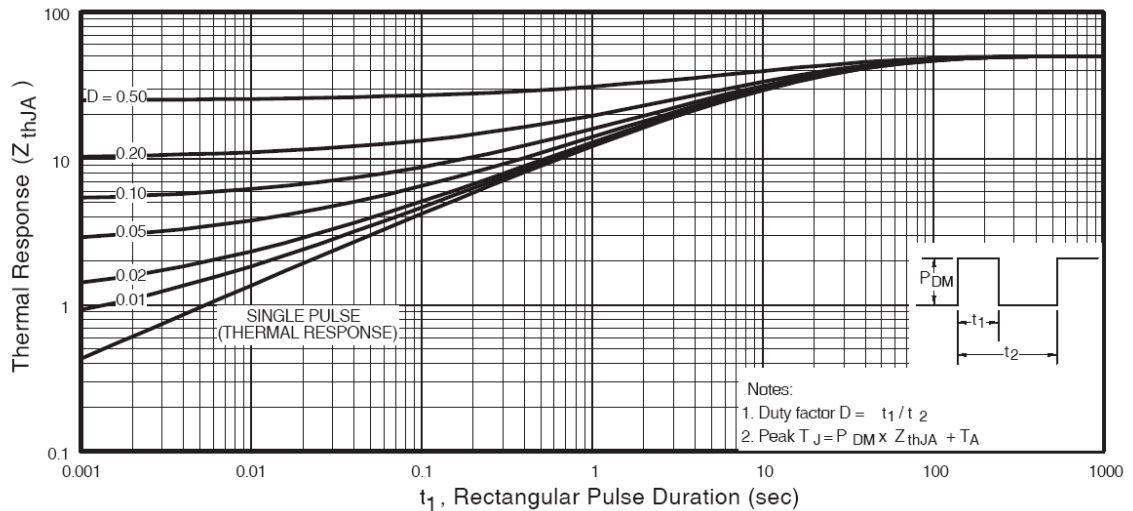
Fig. 1 Normalized On-Resistance vs. Temperature

Fig. 2 Typical Gate Charge vs. Gate-to-Source Voltage

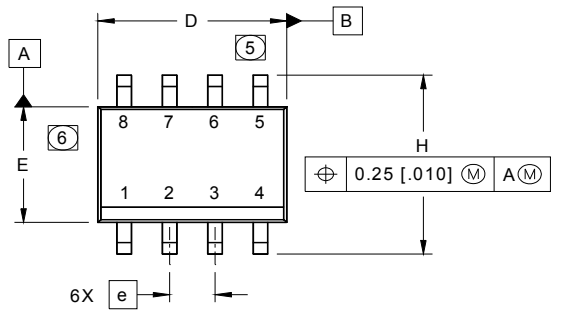
Fig. 3 Typical $R_{DS(on)}$ vs. Gate-to-Source Voltage

Fig. 4 Typical Source-Drain Diode Forward Voltage

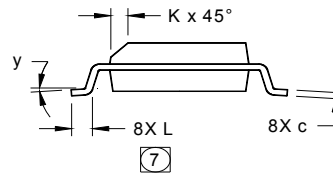
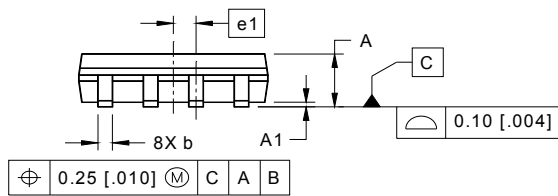
Fig. 5. Maximum Effective Transient Thermal Impedance, Junction-to-Ambient

SO-8 Package Outline (Dimensions are shown in millimeters (inches))



DIM	INCHES		MILLIMETERS	
	MIN	MAX	MIN	MAX
A	.0532	.0688	1.35	1.75
A1	.0040	.0098	0.10	0.25
b	.013	.020	0.33	0.51
c	.0075	.0098	0.19	0.25
D	.189	.1968	4.80	5.00
E	.1497	.1574	3.80	4.00
e	.050 BASIC		1.27 BASIC	
e 1	.025 BASIC		0.635 BASIC	
H	.2284	.2440	5.80	6.20
K	.0099	.0196	0.25	0.50
L	.016	.050	0.40	1.27
y	0°	8°	0°	8°



- NOTES:
1. DIMENSIONING & TOLERANCING PER ASME Y14.5M-1994.
 2. CONTROLLING DIMENSION: MILLIMETER
 3. DIMENSIONS ARE SHOWN IN MILLIMETERS [INCHES].
 4. OUTLINE CONFORMS TO JEDEC OUTLINE MS-012AA.
 5. DIMENSION DOES NOT INCLUDE MOLD PROTRUSIONS. MOLD PROTRUSIONS NOT TO EXCEED 0.15 [0.006].
 6. DIMENSION DOES NOT INCLUDE MOLD PROTRUSIONS. MOLD PROTRUSIONS NOT TO EXCEED 0.25 [0.010].
 7. DIMENSION IS THE LENGTH OF LEAD FOR SOLDERING TO A SUBSTRATE.

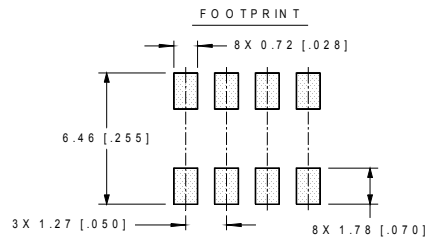

SO-8 Part Marking Information

EXAMPLE: THIS IS AN IRF7101 (MOSFET)

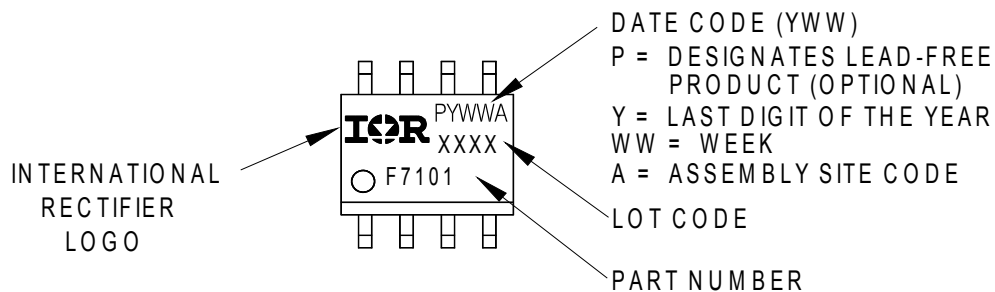

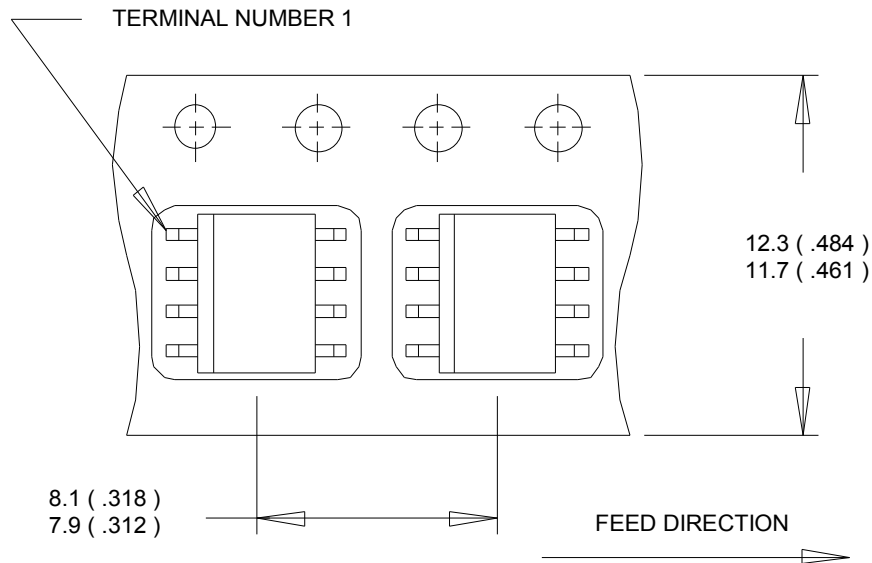
SO-8 Tape and Reel (Dimensions are shown in millimeters (inches))

NOTES:

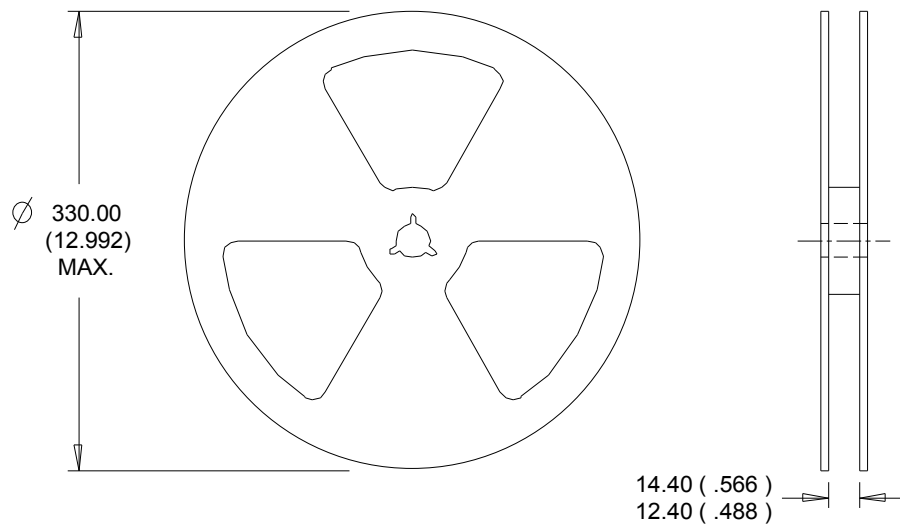
1. CONTROLLING DIMENSION : MILLIMETER.
2. ALL DIMENSIONS ARE SHOWN IN MILLIMETERS(INCHES).
3. OUTLINE CONFORMS TO EIA-481 & EIA-541.

NOTES :

1. CONTROLLING DIMENSION : MILLIMETER.
2. OUTLINE CONFORMS TO EIA-481 & EIA-541.

Qualification Information

Qualification Level	Industrial	
Moisture Sensitivity Level	SO-8	MSL1 (per JEDEC J-STD-020D) [†]
RoHS Compliant	Yes	

[†] Applicable version of JEDEC standard at the time of product release.

Revision History

Date	Comments
10/16/2014	<ul style="list-style-type: none"> Corrected part number from "IRF7805PbF-1" to "IRF7805TRPbF-1" -all pages Removed the "IRF7805PbF-1" bulk part number from ordering information on page1
08/23/2016	<ul style="list-style-type: none"> Changed datasheet with Infineon logo - all pages. Corrected typo Qoss from typ/max "3.0nC/3.6nC" to "30nC/36nC" on page 2. Added disclaimer on last page.

Trademarks of Infineon Technologies AG

μHVIC™, μIPM™, μPFC™, AU-ConvertIR™, AURIX™, C166™, CanPAK™, CIPOS™, CIPURSE™, CoolDP™, CoolGaN™, COOLiR™, CoolMOS™, CoolSET™, CoolSiC™, DAVE™, DI-POL™, DirectFET™, DrBlade™, EasyPIM™, EconoBRIDGE™, EconoDUAL™, EconoPACK™, EconoPIM™, EiceDRIVER™, eupec™, FCOS™, GaNpowIR™, HEXFET™, HITFET™, HybridPACK™, iMOTION™, IRAM™, ISOFACE™, IsoPACK™, LEDrivr™, LITIX™, MIPAQ™, ModSTACK™, my-d™, NovalithIC™, OPTIGA™, OptiMOS™, ORIGAT™, PowIRaudio™, PowIRstage™, PrimePACK™, PrimeSTACK™, PROFET™, PRO-SiL™, RASiC™, REAL3™, SmartLEWIS™, SOLID FLASH™, SPOC™, StrongIRFET™, SupIRBuck™, TEMPFET™, TRENCHSTOP™, TriCore™, UHVIC™, XHP™, XMC™

Trademarks updated November 2015

Other Trademarks

All referenced product or service names and trademarks are the property of their respective owners.

Edition 2016-04-19

Published by
Infineon Technologies AG
81726 Munich, Germany

© 2016 Infineon Technologies AG.
All Rights Reserved.

Do you have a question about this document?
Email: erratum@infineon.com

Document reference
ifx1

IMPORTANT NOTICE

The information given in this document shall in no event be regarded as a guarantee of conditions or **characteristics ("Beschaffenheitsgarantie")**.

With respect to any examples, hints or any typical values stated herein and/or any information regarding the application of the product, Infineon Technologies hereby disclaims any and all warranties and liabilities of any kind, including without limitation warranties of non-infringement of intellectual property rights of any third party.

In addition, any information given in this document **is subject to customer's compliance with its obligations** stated in this document and any applicable legal requirements, norms and standards concerning customer's products and any use of the product of Infineon Technologies in **customer's applications**.

The data contained in this document is exclusively intended for technically trained staff. It is the **responsibility of customer's technical departments** to evaluate the suitability of the product for the intended application and the completeness of the product information given in this document with respect to such application.

For further information on the product, technology, delivery terms and conditions and prices please contact your nearest Infineon Technologies office (www.infineon.com).

Please note that this product is not qualified according to the AEC Q100 or AEC Q101 documents of the Automotive Electronics Council.

WARNINGS

Due to technical requirements products may contain dangerous substances. For information on the types in question please contact your nearest Infineon Technologies office.

Except as otherwise explicitly approved by Infineon Technologies in a written document signed by authorized representatives of Infineon Technologies, **Infineon Technologies' products may not be used** in any applications where a failure of the product or any consequences of the use thereof can reasonably be expected to result in personal injury.