

IRF8714GPbF

HEXFET® Power MOSFET

Applications

- Control MOSFET of Sync-Buck Converters used for Notebook Processor Power
- Control MOSFET for Isolated DC-DC Converters in Networking Systems

V_{DS}	$R_{DS(on)}$ max	Qg
30V	8.7mΩ @ $V_{GS} = 10V$	8.1nC

Benefits

- Very Low Gate Charge
- Very Low $R_{DS(on)}$ at 4.5V V_{GS}
- Ultra-Low Gate Impedance
- Fully Characterized Avalanche Voltage and Current
- 20V V_{GS} Max. Gate Rating
- 100% tested for Rg
- Lead-Free
- Halogen-Free



Description

The IRF8714GPbF incorporates the latest HEXFET Power MOSFET Silicon Technology into the industry standard SO-8 package. The IRF8714GPbF has been optimized for parameters that are critical in synchronous buck operation including $R_{ds(on)}$ and gate charge to reduce both conduction and switching losses. The reduced total losses make this product ideal for high efficiency DC-DC converters that power the latest generation of processors for Notebook and Netcom applications.

Absolute Maximum Ratings

	Parameter	Max.	Units
V_{DS}	Drain-to-Source Voltage	30	V
V_{GS}	Gate-to-Source Voltage	± 20	
$I_D @ T_A = 25^\circ C$	Continuous Drain Current, $V_{GS} @ 10V$	14	A
$I_D @ T_A = 70^\circ C$	Continuous Drain Current, $V_{GS} @ 10V$	11	
I_{DM}	Pulsed Drain Current ①	110	
$P_D @ T_A = 25^\circ C$	Power Dissipation	2.5	W
$P_D @ T_A = 70^\circ C$	Power Dissipation	1.6	
	Linear Derating Factor	0.02	W/°C
T_J	Operating Junction and	-55 to + 150	°C
T_{STG}	Storage Temperature Range		

Thermal Resistance

	Parameter	Typ.	Max.	Units
$R_{\theta JL}$	Junction-to-Drain Lead ⑤	—	20	°C/W
$R_{\theta JA}$	Junction-to-Ambient ⑥	—	50	

Notes ① through ⑥ are on page 9
www.irf.com

IRF8714GPbF

International
IR Rectifier

Static @ $T_J = 25^\circ\text{C}$ (unless otherwise specified)

	Parameter	Min.	Typ.	Max.	Units	Conditions
BV_{DSS}	Drain-to-Source Breakdown Voltage	30	—	—	V	$V_{GS} = 0V, I_D = 250\mu A$
$\Delta BV_{DSS}/\Delta T_J$	Breakdown Voltage Temp. Coefficient	—	0.021	—	V/°C	Reference to $25^\circ\text{C}, I_D = 1mA$
$R_{DS(on)}$	Static Drain-to-Source On-Resistance	—	7.1	8.7	mΩ	$V_{GS} = 10V, I_D = 14A$ ③
		—	10.9	13		$V_{GS} = 4.5V, I_D = 11A$ ③
$V_{GS(th)}$	Gate Threshold Voltage	1.35	1.80	2.35	V	$V_{DS} = V_{GS}, I_D = 25\mu A$
$\Delta V_{GS(th)}$	Gate Threshold Voltage Coefficient	—	-6.0	—	mV/°C	$V_{DS} = V_{GS}, I_D = 25\mu A$
I_{DSS}	Drain-to-Source Leakage Current	—	—	1.0	μA	$V_{DS} = 24V, V_{GS} = 0V$
		—	—	150		$V_{DS} = 24V, V_{GS} = 0V, T_J = 125^\circ\text{C}$
I_{GSS}	Gate-to-Source Forward Leakage	—	—	100	nA	$V_{GS} = 20V$
	Gate-to-Source Reverse Leakage	—	—	-100		$V_{GS} = -20V$
g_{fs}	Forward Transconductance	71	—	—	S	$V_{DS} = 15V, I_D = 11A$
Q_g	Total Gate Charge	—	8.1	12	nC	$V_{DS} = 15V$ $V_{GS} = 4.5V$ $I_D = 11A$ See Figs. 15 & 16
Q_{gs1}	Pre-V _{th} Gate-to-Source Charge	—	1.9	—		
Q_{gs2}	Post-V _{th} Gate-to-Source Charge	—	1.0	—		
Q_{gd}	Gate-to-Drain Charge	—	3.0	—		
Q_{godr}	Gate Charge Overdrive	—	2.2	—		
Q_{sw}	Switch Charge ($Q_{gs2} + Q_{gd}$)	—	4.0	—	nC	$V_{DS} = 16V, V_{GS} = 0V$
Q_{oss}	Output Charge	—	4.8	—	nC	$V_{DS} = 16V, V_{GS} = 0V$
R_g	Gate Resistance	—	1.6	2.6	Ω	
$t_{d(on)}$	Turn-On Delay Time	—	10	—	ns	$V_{DD} = 15V, V_{GS} = 4.5V$ $I_D = 11A$ $R_G = 1.8\Omega$ See Fig. 18
t_r	Rise Time	—	9.9	—		
$t_{d(off)}$	Turn-Off Delay Time	—	11	—		
t_f	Fall Time	—	5.0	—		
C_{iss}	Input Capacitance	—	1020	—	pF	$V_{GS} = 0V$ $V_{DS} = 15V$ $f = 1.0MHz$
C_{oss}	Output Capacitance	—	220	—		
C_{riss}	Reverse Transfer Capacitance	—	110	—		

Avalanche Characteristics

	Parameter	Typ.	Max.	Units
E_{AS}	Single Pulse Avalanche Energy ②	—	65	mJ
I_{AR}	Avalanche Current ①	—	11	A

Diode Characteristics

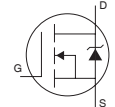
	Parameter	Min.	Typ.	Max.	Units	Conditions
I_S	Continuous Source Current (Body Diode)	—	—	3.1	A	MOSFET symbol showing the integral reverse p-n junction diode. 
I_{SM}	Pulsed Source Current (Body Diode) ①	—	—	110		
V_{SD}	Diode Forward Voltage	—	—	1.0	V	$T_J = 25^\circ\text{C}, I_S = 11A, V_{GS} = 0V$ ③
t_{rr}	Reverse Recovery Time	—	14	21	ns	$T_J = 25^\circ\text{C}, I_F = 11A, V_{DD} = 15V$
Q_{rr}	Reverse Recovery Charge	—	15	23	nC	$di/dt = 300A/\mu s$ ③
t_{on}	Forward Turn-On Time	Intrinsic turn-on time is negligible (turn-on is dominated by LS+LD)				

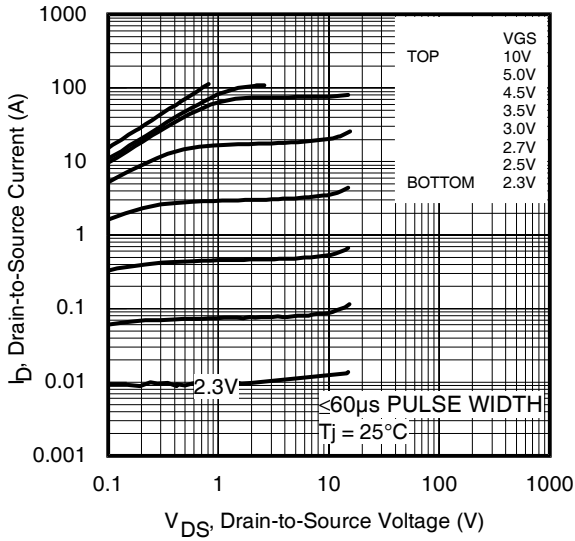

Fig 1. Typical Output Characteristics

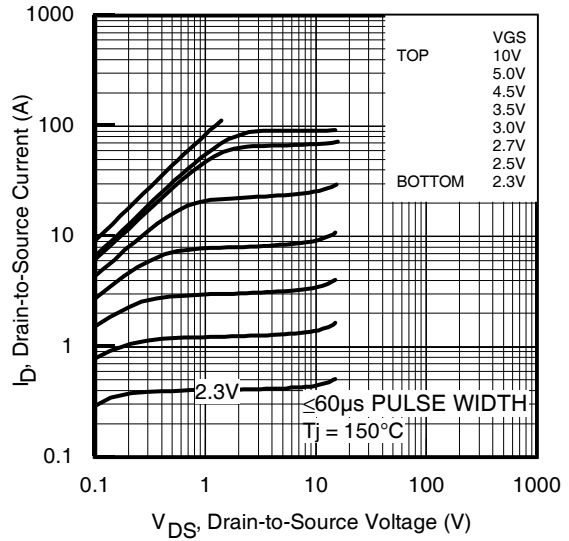

Fig 2. Typical Output Characteristics

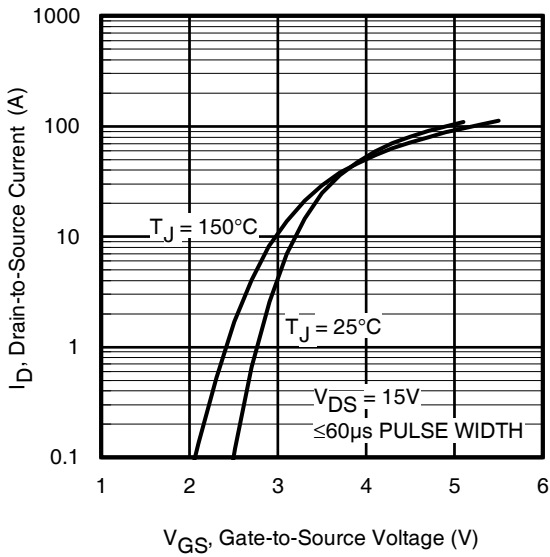

Fig 3. Typical Transfer Characteristics

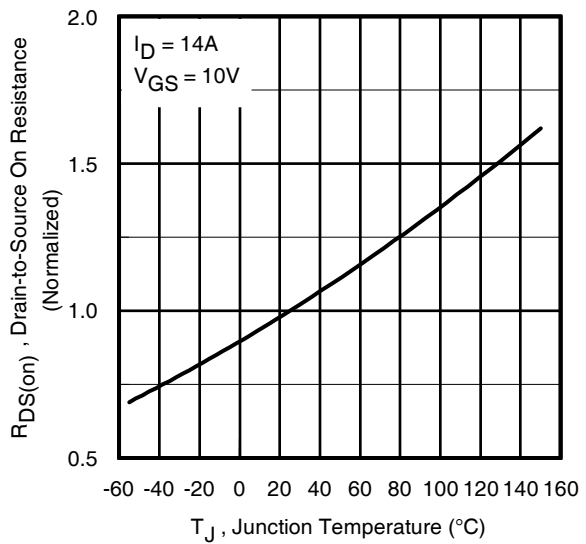

Fig 4. Normalized On-Resistance vs. Temperature

IRF8714GPbF

International
IR Rectifier

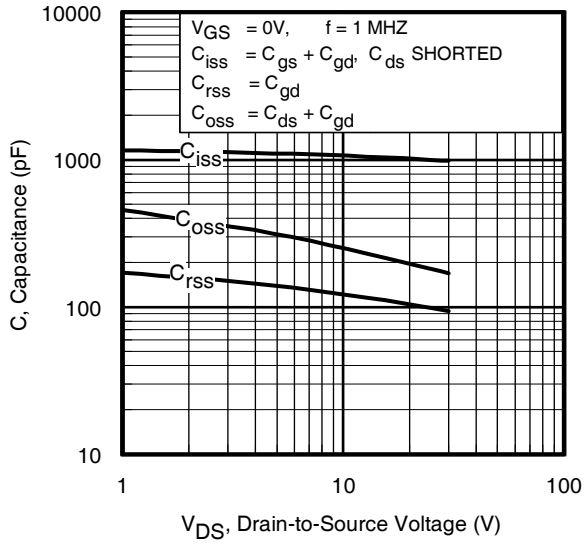

Fig 5. Typical Capacitance vs. Drain-to-Source Voltage

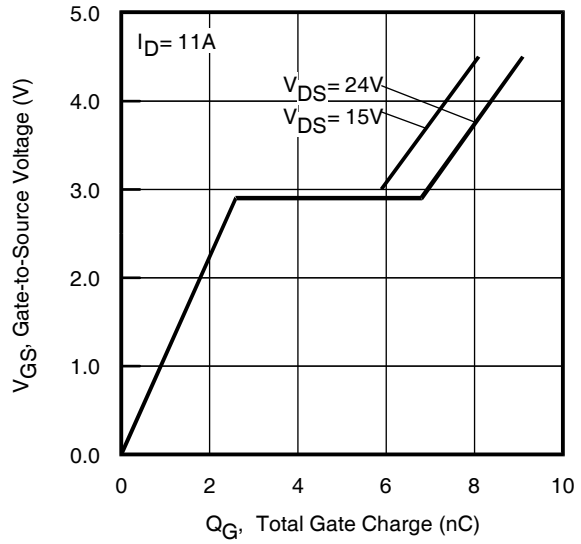

Fig 6. Typical Gate Charge Vs. Gate-to-Source Voltage

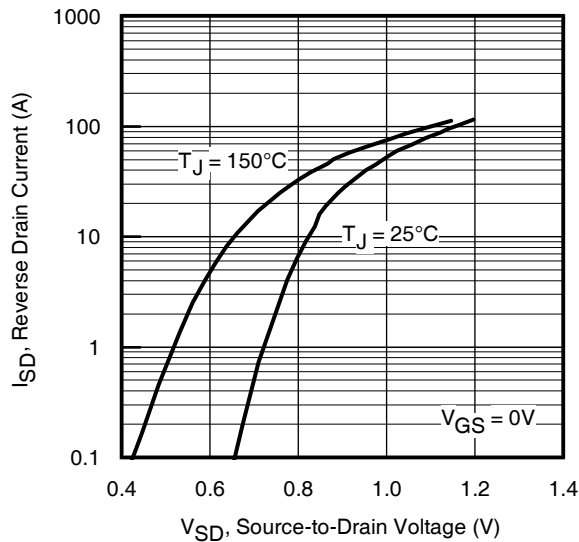

Fig 7. Typical Source-Drain Diode Forward Voltage

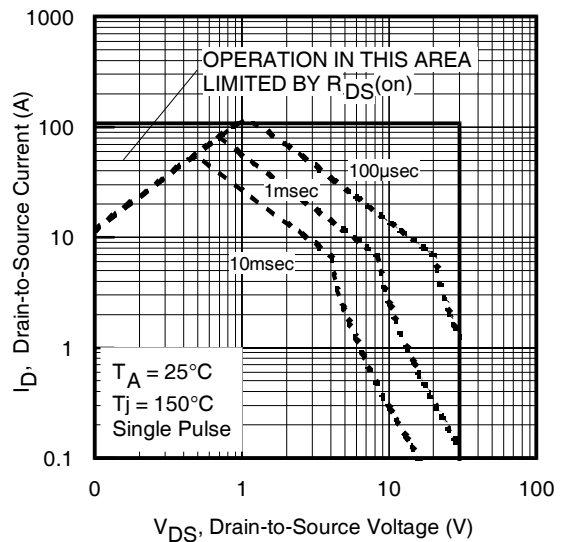

Fig 8. Maximum Safe Operating Area

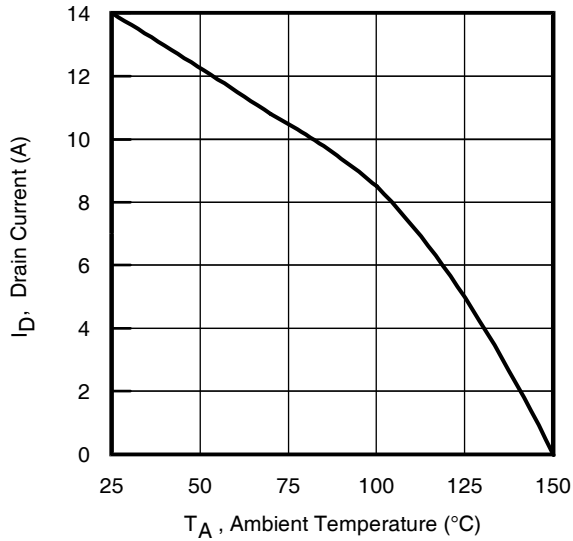

Fig 9. Maximum Drain Current vs. Ambient Temperature

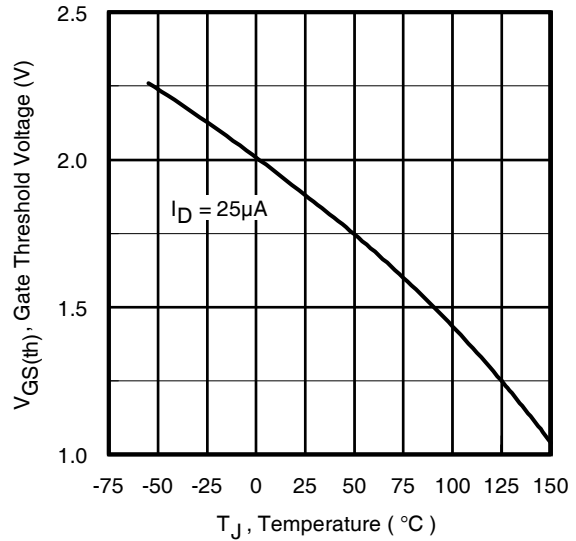

Fig 10. Threshold Voltage vs. Temperature

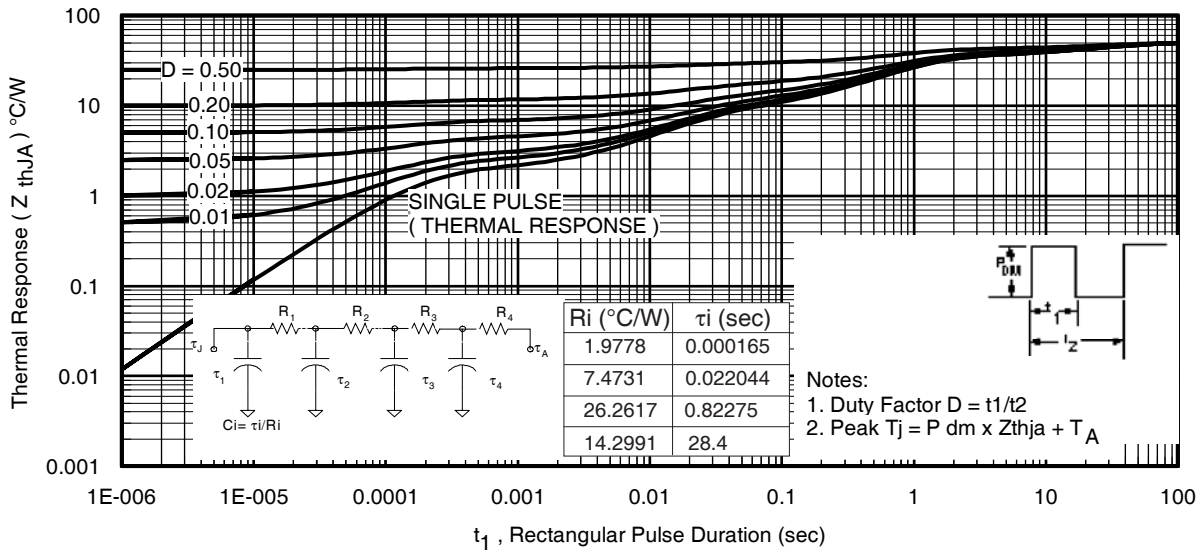

Fig 11. Maximum Effective Transient Thermal Impedance, Junction-to-Ambient

IRF8714GPbF

International
IR Rectifier

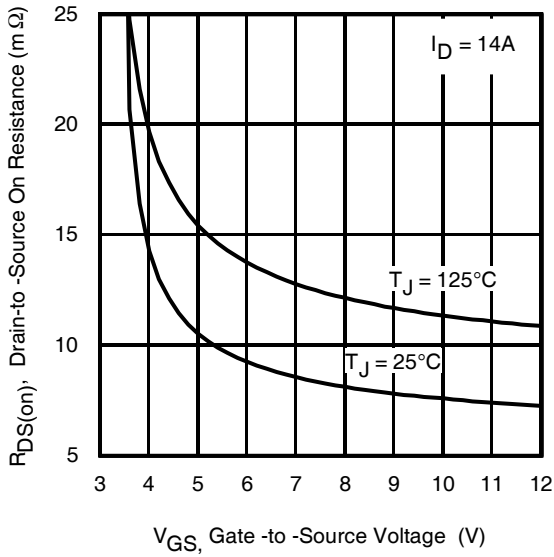

Fig 12. On-Resistance vs. Gate Voltage

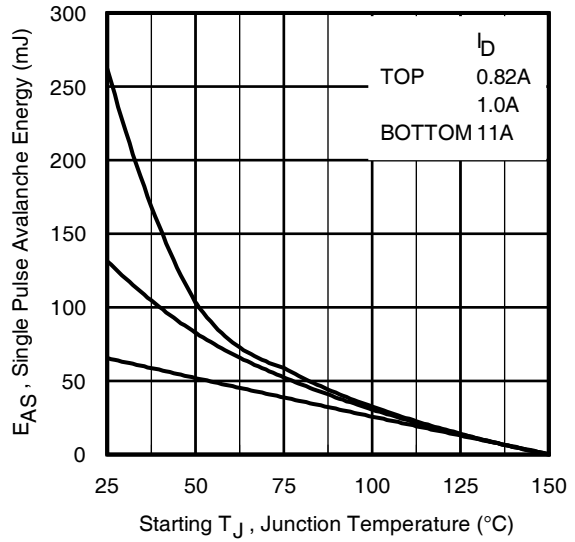

Fig 13. Maximum Avalanche Energy vs. Drain Current

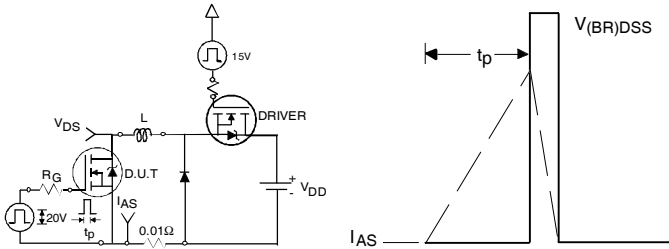

Fig 14. Unclamped Inductive Test Circuit and Waveform

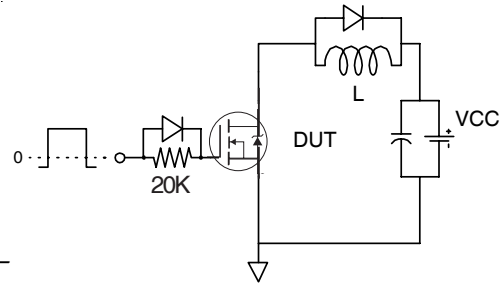
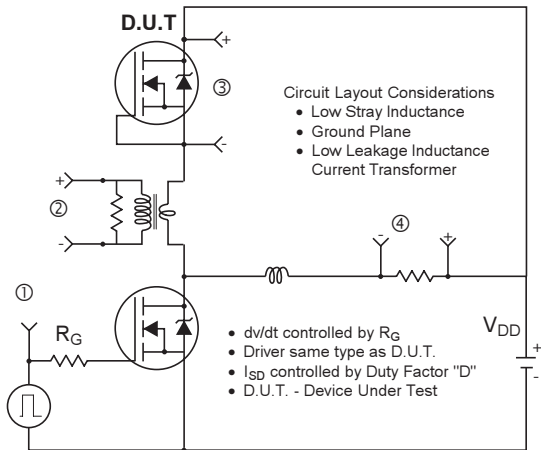

Fig 15. Gate Charge Test Circuit



Fig 16. Gate Charge Waveform



* $V_{GS} = 5V$ for Logic Level Devices

Fig 17. Peak Diode Recovery dv/dt Test Circuit for N-Channel HEXFET® Power MOSFETS

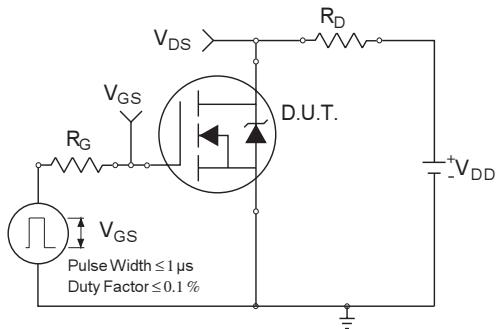

Fig 18a. Switching Time Test Circuit

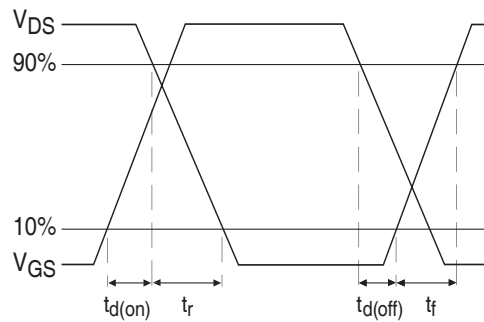
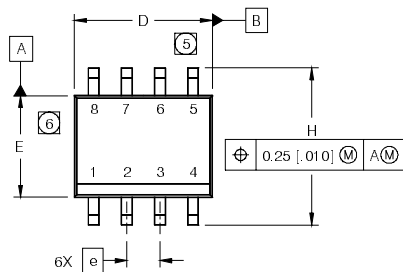

Fig 18b. Switching Time Waveforms

IRF8714GPbF

SO-8 Package Outline (MOSFET & Fetky)

Dimensions are shown in millimeters (inches)



DIM	INCHES		MILLIMETERS	
	MIN	MAX	MIN	MAX
A	.0532	.0688	1.35	1.75
A1	.0040	.0098	0.10	0.25
b	.013	.020	0.33	0.51
c	.0075	.0098	0.19	0.25
D	.189	.1968	4.80	5.00
E	.1497	.1574	3.80	4.00
e	.060 BASIC		1.27 BASIC	
e1	.025 BASIC		0.635 BASIC	
H	.2284	.2440	5.80	6.20
K	.0099	.0196	0.25	0.50
L	.016	.050	0.40	1.27
y	0°	8°	0°	8°

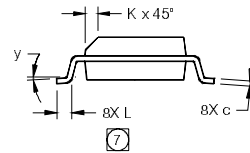
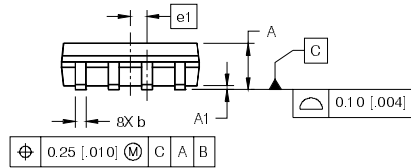

NOTES:

1. DIMENSIONING & TOLERANCING PER ASME Y14.5M-1994.
2. CONTROLLING DIMENSION: MILLIMETER
3. DIMENSIONS ARE SHOWN IN MILLIMETERS [INCHES].
4. OUTLINE CONFORMS TO JEDEC OUTLINE MS-012AA.
5. DIMENSION DOES NOT INCLUDE MOLD PROTRUSIONS. MOLD PROTRUSIONS NOT TO EXCEED 0.15 [0.006].
6. DIMENSION DOES NOT INCLUDE MOLD PROTRUSIONS. MOLD PROTRUSIONS NOT TO EXCEED 0.25 [0.010].
7. DIMENSION IS THE LENGTH OF LEAD FOR SOLDERING TO A SUBSTRATE.

FOOTPRINT

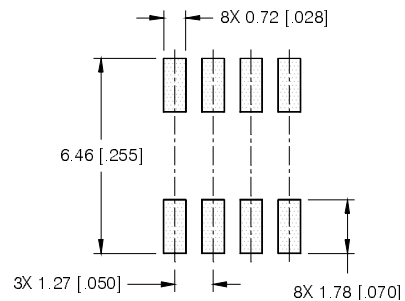

SO-8 Part Marking Information

EXAMPLE: THIS IS AN IRF8707GPBF

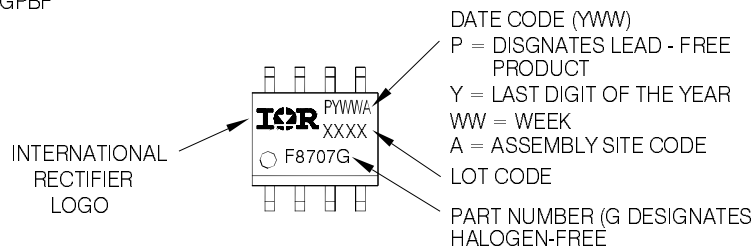

Note: For the most current drawing please refer to IR website at <http://www.irf.com/package/>

SO-8 Tape and Reel

Dimensions are shown in millimeters (inches)

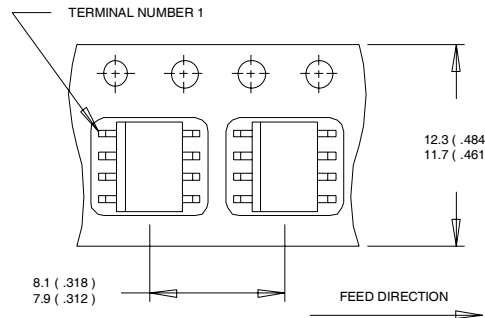

- NOTES:
1. CONTROLLING DIMENSION : MILLIMETER.
 2. ALL DIMENSIONS ARE SHOWN IN MILLIMETERS(INCHES).
 3. OUTLINE CONFORMS TO EIA-481 & EIA-541.

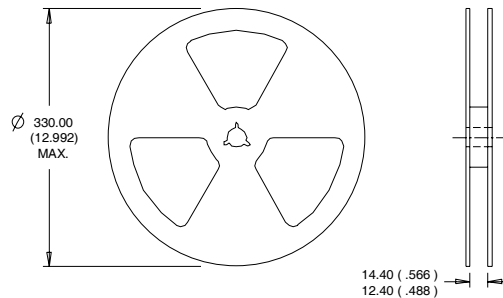

- NOTES:
1. CONTROLLING DIMENSION : MILLIMETER.
 2. OUTLINE CONFORMS TO EIA-481 & EIA-541.

Notes:

- ① Repetitive rating; pulse width limited by max. junction temperature.
- ② Starting $T_J = 25^\circ\text{C}$, $L = 1.1\text{mH}$, $R_G = 25\Omega$, $I_{AS} = 11\text{A}$.
- ③ Pulse width $\leq 400\mu\text{s}$; duty cycle $\leq 2\%$.
- ④ When mounted on 1 inch square copper board.
- ⑤ R_θ is measured at T_J of approximately 90°C .

Note: For the most current drawing please refer to IR website at <http://www.irf.com/package>

Data and specifications subject to change without notice.
 This product has been designed and qualified for the Consumer market.
 Qualification Standards can be found on IR's Web site.