

IRF8788PbF

HEXFET® Power MOSFET

Applications

- Synchronous MOSFET for Notebook Processor Power
- Synchronous Rectifier MOSFET for Isolated DC-DC Converters

V_{DSS}	$R_{DS(on)}$ max	Qg
30V	2.8mΩ @ $V_{GS} = 10V$	44nC

Benefits

- Very Low Gate Charge
- Very Low $R_{DS(on)}$ at 4.5V V_{GS}
- Ultra-Low Gate Impedance
- Fully Characterized Avalanche Voltage and Current
- 20V V_{GS} Max. Gate Rating
- 100% tested for Rg
- Lead-Free

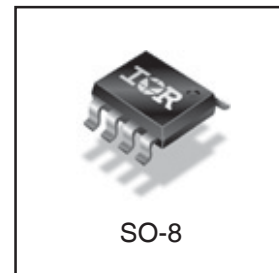
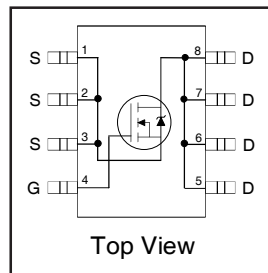

Description

The IRF8788PbF incorporates the latest HEXFET Power MOSFET Silicon Technology into the industry standard SO-8 package. The IRF8788PbF has been optimized for parameters that are critical in synchronous buck operation including $R_{ds(on)}$ and gate charge to reduce both conduction and switching losses. The reduced total losses make this product ideal for high efficiency DC-DC converters that power the latest generation of processors for notebook and Netcom applications.

Absolute Maximum Ratings

	Parameter	Max.	Units
V_{DS}	Drain-to-Source Voltage	30	V
V_{GS}	Gate-to-Source Voltage	±20	
$I_D @ T_A = 25^\circ\text{C}$	Continuous Drain Current, $V_{GS} @ 10V$	24	A
$I_D @ T_A = 70^\circ\text{C}$	Continuous Drain Current, $V_{GS} @ 10V$	19	
I_{DM}	Pulsed Drain Current ①	190	
$P_D @ T_A = 25^\circ\text{C}$	Power Dissipation	2.5	W
$P_D @ T_A = 70^\circ\text{C}$	Power Dissipation	1.6	
	Linear Derating Factor	0.02	W/°C
T_J	Operating Junction and	-55 to + 150	°C
T_{STG}	Storage Temperature Range		

Thermal Resistance

	Parameter	Typ.	Max.	Units
$R_{\theta JL}$	Junction-to-Drain Lead ⑤	—	20	°C/W
$R_{\theta JA}$	Junction-to-Ambient ④⑤	—	50	

Notes ① through ⑤ are on page 9

www.irf.com

1
8/18/08

IRF8788PbF

 International
IR Rectifier

Static @ T_J = 25°C (unless otherwise specified)

	Parameter	Min.	Typ.	Max.	Units	Conditions
BV _{DSS}	Drain-to-Source Breakdown Voltage	30	—	—	V	V _{GS} = 0V, I _D = 250μA
ΔBV _{DSS} /ΔT _J	Breakdown Voltage Temp. Coefficient	—	0.024	—	V/°C	Reference to 25°C, I _D = 1mA
R _{DS(on)}	Static Drain-to-Source On-Resistance	—	2.3	2.8	mΩ	V _{GS} = 10V, I _D = 24A ③
		—	3.04	3.8		V _{GS} = 4.5V, I _D = 19A ③
V _{GS(th)}	Gate Threshold Voltage	1.35	1.80	2.35	V	V _{DS} = V _{GS} , I _D = 100μA
ΔV _{GS(th)}	Gate Threshold Voltage Coefficient	—	-6.59	—	mV/°C	
I _{DSS}	Drain-to-Source Leakage Current	—	—	1.0	μA	V _{DS} = 24V, V _{GS} = 0V
		—	—	150		V _{DS} = 24V, V _{GS} = 0V, T _J = 125°C
I _{GSS}	Gate-to-Source Forward Leakage	—	—	100	nA	V _{GS} = 20V
	Gate-to-Source Reverse Leakage	—	—	-100		V _{GS} = -20V
g _{fs}	Forward Transconductance	95	—	—	S	V _{DS} = 15V, I _D = 19A
Q _g	Total Gate Charge	—	44	66	nC	V _{DS} = 15V V _{GS} = 4.5V I _D = 19A See Figs. 17a & 17b
Q _{gs1}	Pre-V _{th} Gate-to-Source Charge	—	12	—		
Q _{gs2}	Post-V _{th} Gate-to-Source Charge	—	4.7	—		
Q _{gd}	Gate-to-Drain Charge	—	14	—		
Q _{godr}	Gate Charge Overdrive	—	13.3	—		
Q _{sw}	Switch Charge (Q _{gs2} + Q _{gd})	—	18.7	—		
Q _{oss}	Output Charge	—	22	—	nC	V _{DS} = 16V, V _{GS} = 0V
R _g	Gate Resistance	—	0.54	1.09	Ω	
t _{d(on)}	Turn-On Delay Time	—	23	—	ns	V _{DD} = 15V, V _{GS} = 4.5V I _D = 19A R _G = 1.8Ω See Fig. 15a & 15b
t _r	Rise Time	—	24	—		
t _{d(off)}	Turn-Off Delay Time	—	23	—		
t _f	Fall Time	—	11	—		
C _{iss}	Input Capacitance	—	5720	—	pF	V _{GS} = 0V V _{DS} = 15V f = 1.0MHz
C _{oss}	Output Capacitance	—	980	—		
C _{rss}	Reverse Transfer Capacitance	—	450	—		

Avalanche Characteristics

	Parameter	Typ.	Max.	Units
E _{AS}	Single Pulse Avalanche Energy ②	—	230	mJ
I _{AR}	Avalanche Current ①	—	19	A

Diode Characteristics

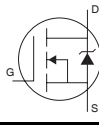
	Parameter	Min.	Typ.	Max.	Units	Conditions
I _S	Continuous Source Current (Body Diode)	—	—	3.1	A	MOSFET symbol showing the integral reverse p-n junction diode. 
I _{SM}	Pulsed Source Current (Body Diode) ①	—	—	190	A	
V _{SD}	Diode Forward Voltage	—	—	1.0	V	T _J = 25°C, I _S = 19A, V _{GS} = 0V ③
		—	—	0.75	V	T _J = 25°C, I _S = 2.2A, V _{GS} = 0V ③
t _{rr}	Reverse Recovery Time	—	24	36	ns	T _J = 25°C, I _F = 19A, V _{DD} = 15V
Q _{rr}	Reverse Recovery Charge	—	33	50	nC	di/dt = 230A/μs ③
t _{on}	Forward Turn-On Time	Intrinsic turn-on time is negligible (turn-on is dominated by LS+LD)				

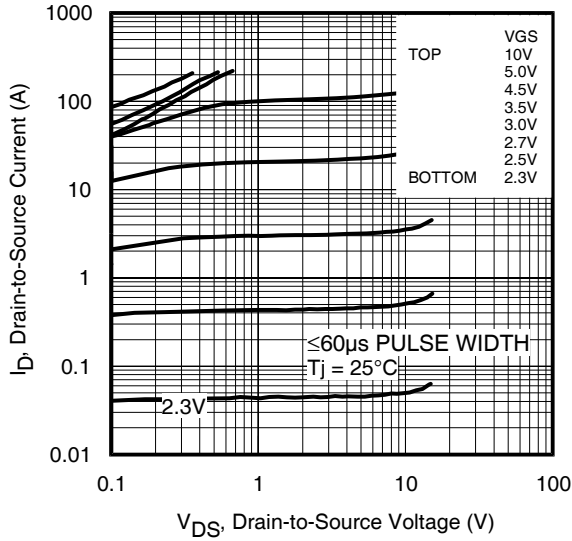

Fig 1. Typical Output Characteristics

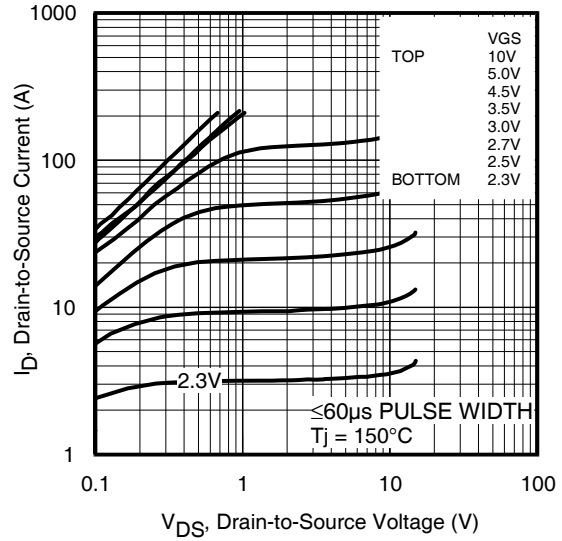

Fig 2. Typical Output Characteristics

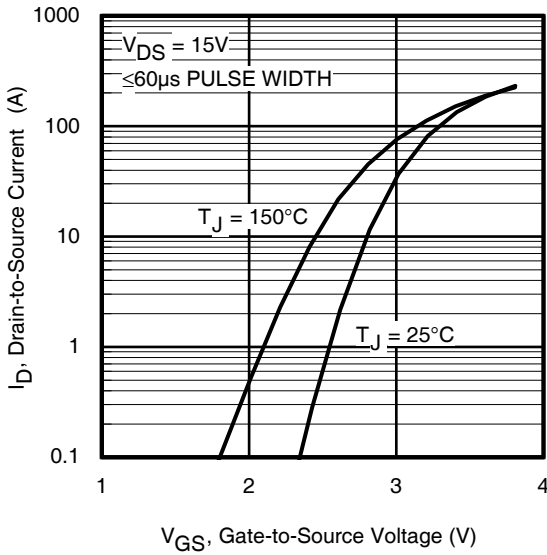

Fig 3. Typical Transfer Characteristics

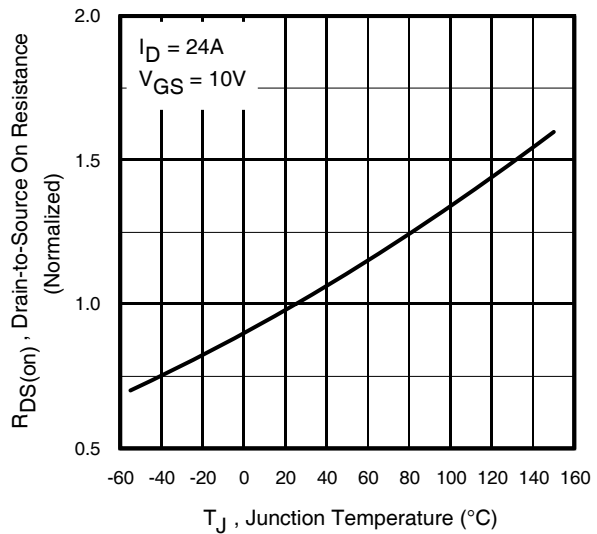

Fig 4. Normalized On-Resistance vs. Temperature

IRF8788PbF

International
IR Rectifier

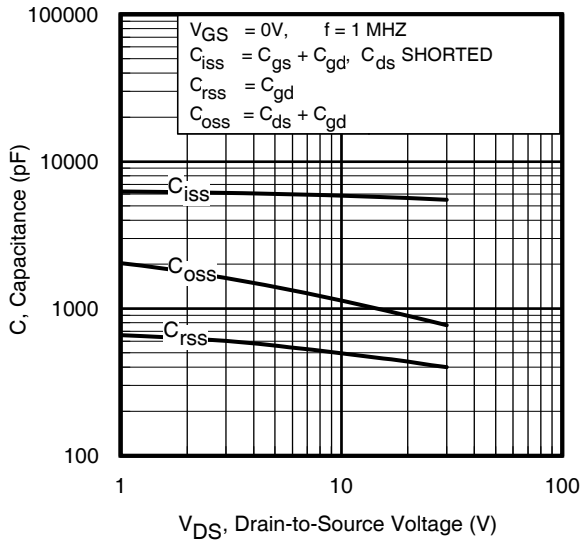

Fig 5. Typical Capacitance vs. Drain-to-Source Voltage

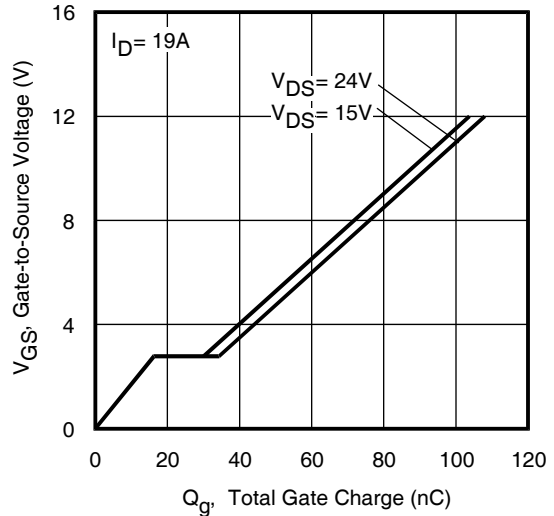

Fig 6. Typical Gate Charge vs. Gate-to-Source Voltage

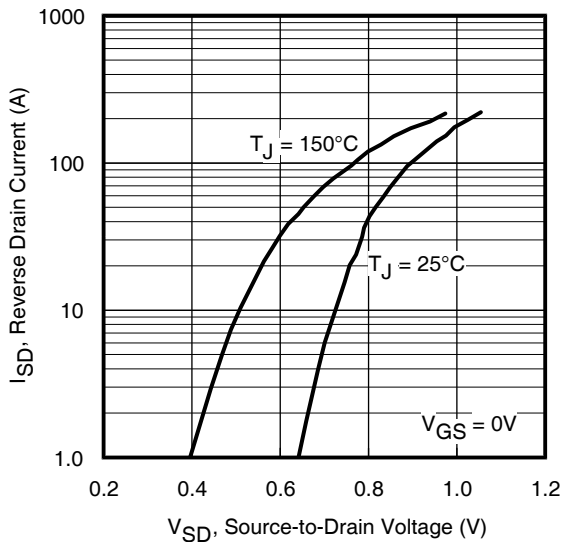

Fig 7. Typical Source-Drain Diode Forward Voltage

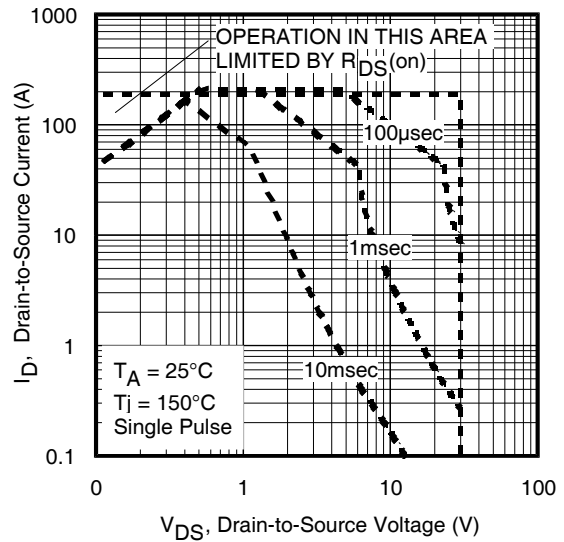

Fig 8. Maximum Safe Operating Area

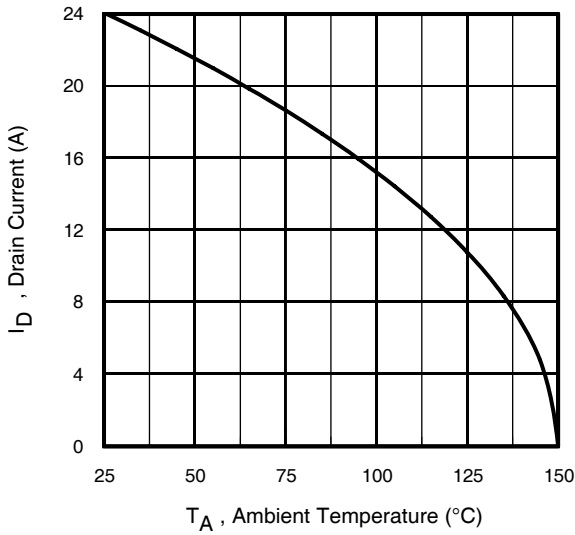

Fig 9. Maximum Drain Current vs. Ambient Temperature

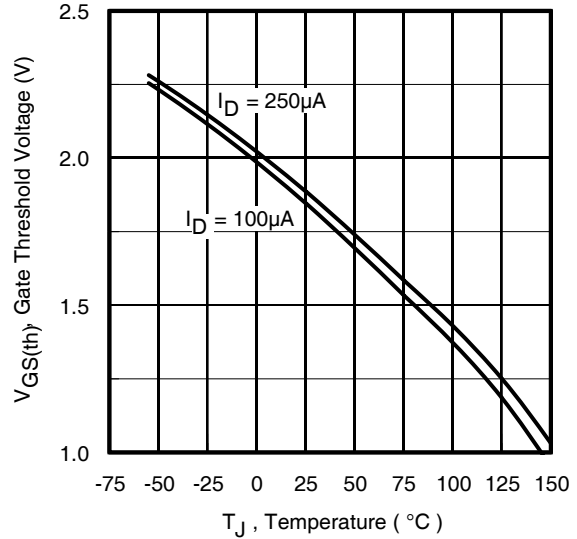

Fig 10. Threshold Voltage vs. Temperature

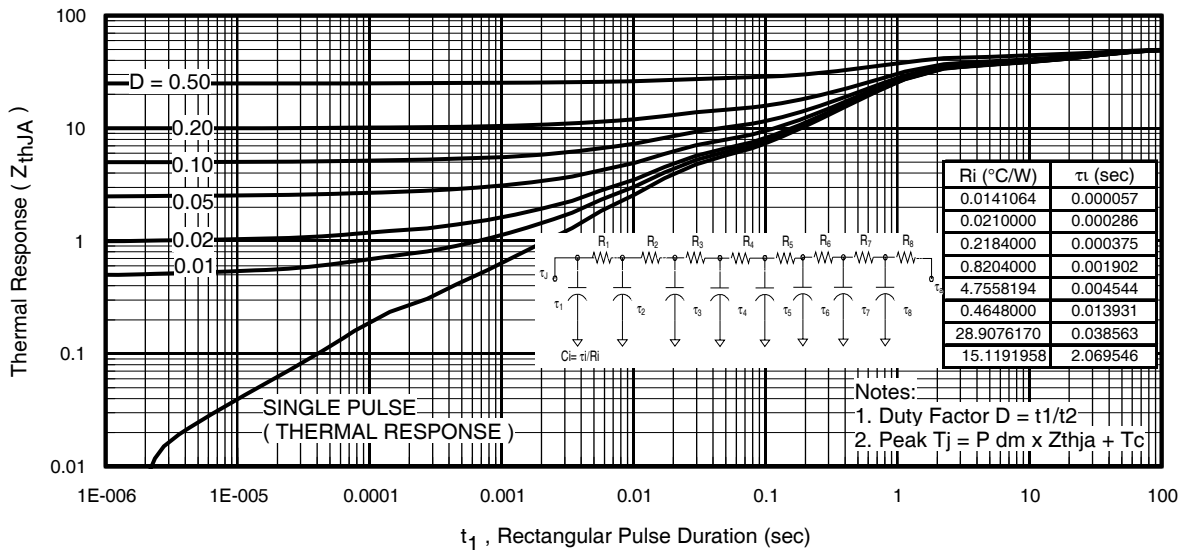

Fig 11. Maximum Effective Transient Thermal Impedance, Junction-to-Ambient

IRF8788PbF

International
IR Rectifier

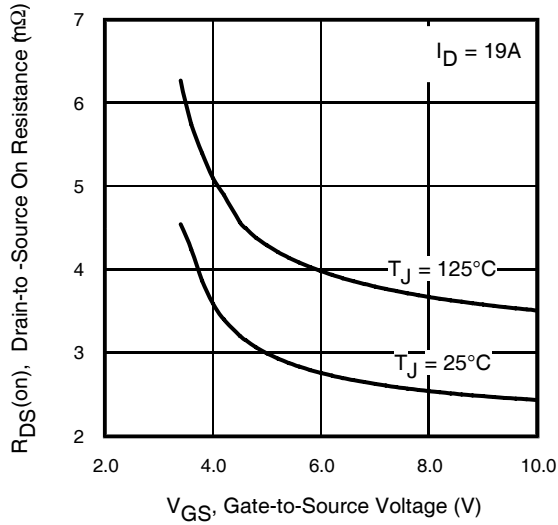

Fig 12. On-Resistance vs. Gate Voltage

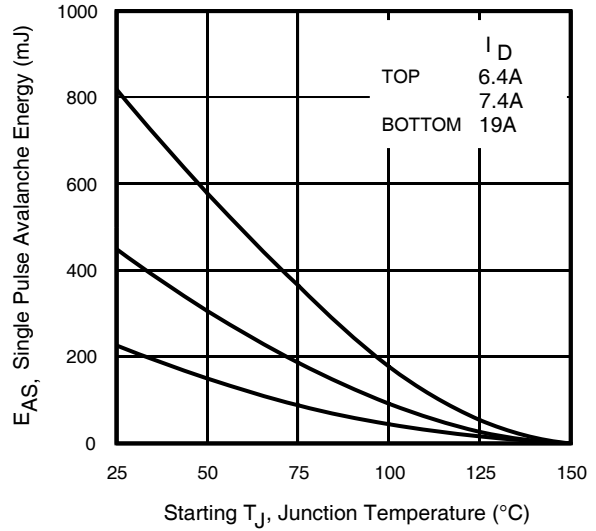

Fig 13. Maximum Avalanche Energy vs. Drain Current

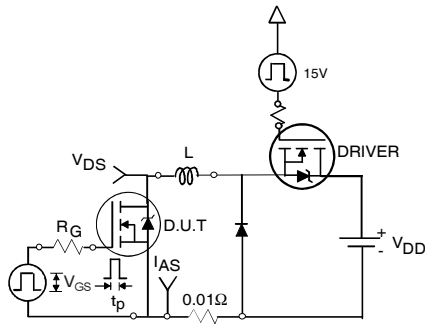

Fig 14a. Unclamped Inductive Test Circuit

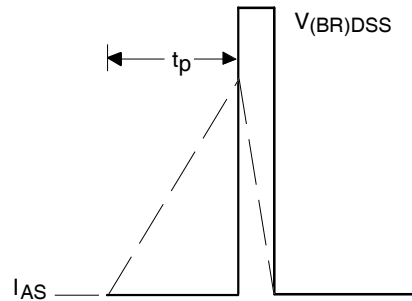

Fig 14b. Unclamped Inductive Waveforms

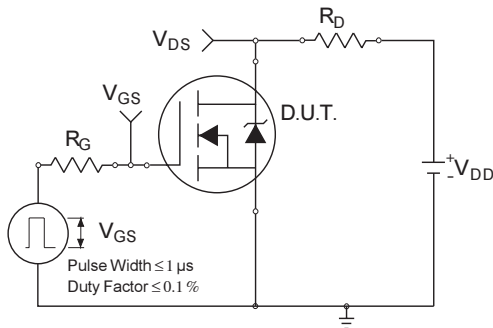

Fig 15a. Switching Time Test Circuit

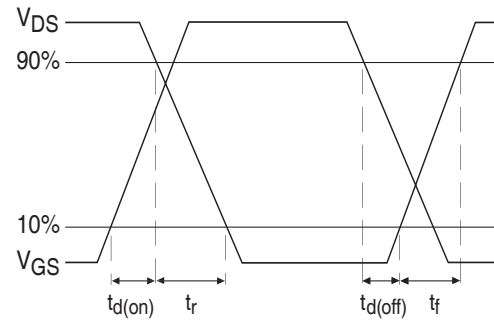
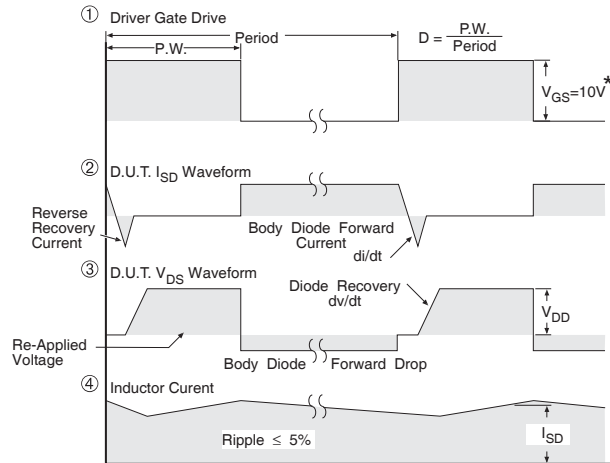
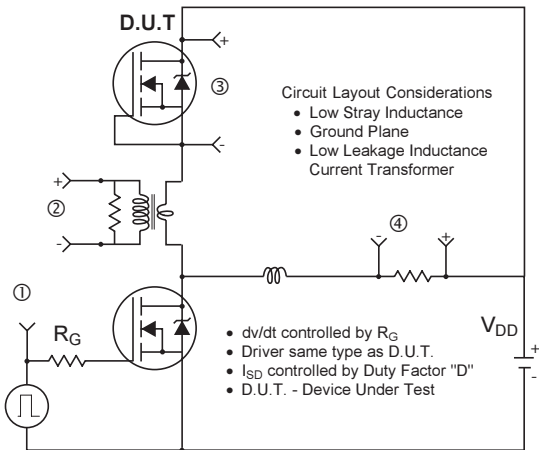

Fig 15b. Switching Time Waveforms

www.irf.com



* $V_{GS} = 5V$ for Logic Level Devices

Fig 16. Peak Diode Recovery dv/dt Test Circuit for N-Channel HEXFET® Power MOSFETs

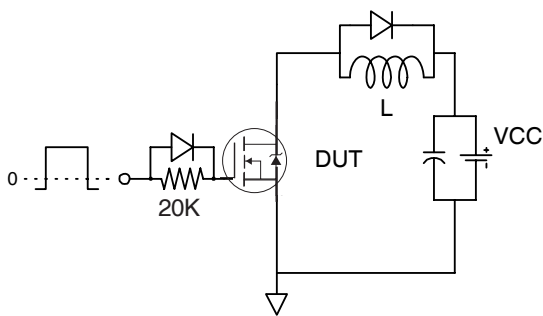

Fig 17a. Gate Charge Test Circuit

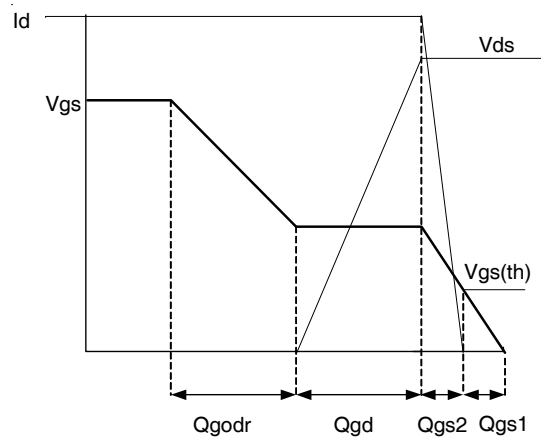

Fig 17b. Gate Charge Waveform

IRF8788PbF

SO-8 Package Outline

International
IR Rectifier

Dimensions are shown in millimeters (inches)

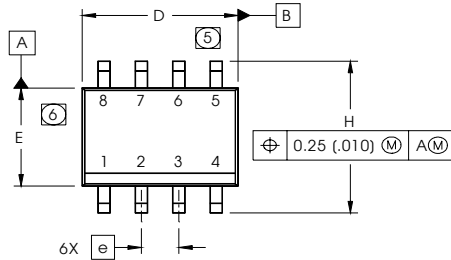

DIM	INCHES		MILLIMETERS	
	MIN	MAX	MIN	MAX
A	.0532	.0688	1.35	1.75
A1	.0040	.0098	0.10	0.25
b	.013	.020	0.33	0.51
c	.0075	.0098	0.19	0.25
D	.189	.1968	4.80	5.00
E	.1497	.1574	3.80	4.00
e	.050 BASIC		1.27 BASIC	
e1	.025 BASIC		0.635 BASIC	
H	.2284	.2440	5.80	6.20
K	.0099	.0196	0.25	0.50
L	.016	.050	0.40	1.27
y	0°	8°	0°	8°

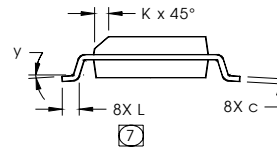
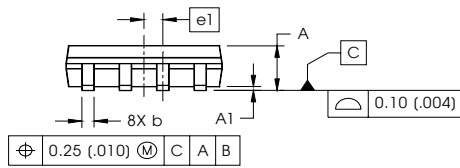

FOOTPRINT

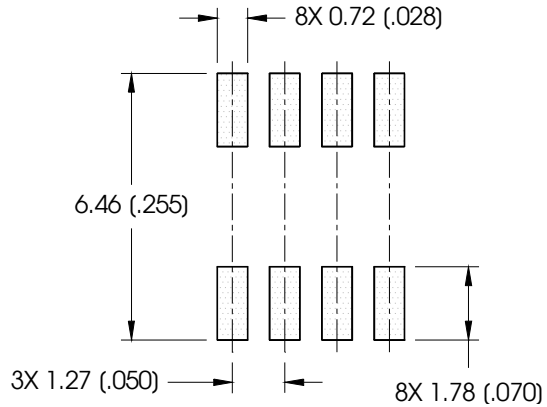

NOTES:

1. DIMENSIONING & TOLERANCING PER ASME Y14.5M-1994.
2. CONTROLLING DIMENSION: MILLIMETER
3. DIMENSIONS ARE SHOWN IN MILLIMETERS (INCHES).
4. OUTLINE CONFORMS TO JEDEC OUTLINE MS-012AA.
- ⑤ DIMENSION DOES NOT INCLUDE MOLD PROTRUSIONS. MOLD PROTRUSIONS NOT TO EXCEED 0.15 (.006).
- ⑥ DIMENSION DOES NOT INCLUDE MOLD PROTRUSIONS. MOLD PROTRUSIONS NOT TO EXCEED 0.25 (.010).
- ⑦ DIMENSION IS THE LENGTH OF LEAD FOR SOLDERING TO A SUBSTRATE.

SO-8 Part Marking Information

EXAMPLE: THIS IS AN IRF7101 (MOSFET)

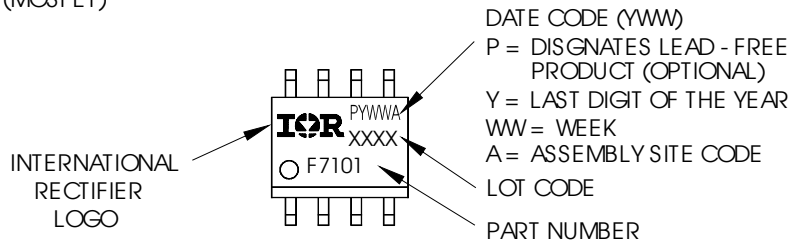

Note: For the most current drawing please refer to IR website at <http://www.irf.com/package/>

International
IR Rectifier

IRF8788PbF

SO-8 Tape and Reel

Dimensions are shown in millimeters (inches)

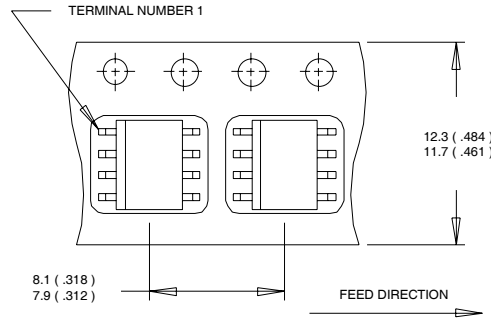

- NOTES:
 1. CONTROLLING DIMENSION : MILLIMETER.
 2. ALL DIMENSIONS ARE SHOWN IN MILLIMETERS(INCHES).
 3. OUTLINE CONFORMS TO EIA-481 & EIA-541.

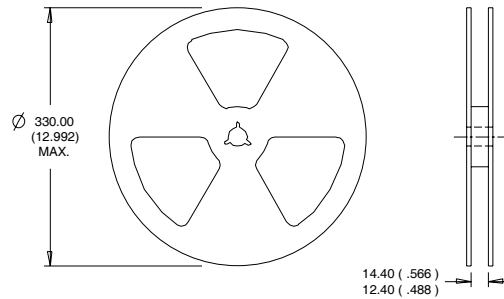

- NOTES :
 1. CONTROLLING DIMENSION : MILLIMETER.
 2. OUTLINE CONFORMS TO EIA-481 & EIA-541.

Notes:

- ① Repetitive rating; pulse width limited by max. junction temperature.
- ② Starting $T_J = 25^\circ\text{C}$, $L = 1.25\text{mH}$, $R_G = 25\Omega$, $I_{AS} = 19\text{A}$.
- ③ Pulse width $\leq 400\mu\text{s}$; duty cycle $\leq 2\%$.
- ④ When mounted on 1 inch square copper board.
- ⑤ R_{θ} is measured at T_J of approximately 90°C .

Note: For the most current drawing please refer to IR website at <http://www.irf.com/package/>

Data and specifications subject to change without notice.
 This product has been designed and qualified for the Consumer market.
 Qualification Standards can be found on IR's Web site.

International
IR Rectifier

IR WORLD HEADQUARTERS: 233 Kansas St., El Segundo, California 90245, USA Tel: (310) 252-7105
 TAC Fax: (310) 252-7903

Visit us at www.irf.com for sales contact information.08/08