

IRFB4215PbF

HEXFET® Power MOSFET

- Advanced Process Technology
- Ultra Low On-Resistance
- Dynamic dv/dt Rating
- 175°C Operating Temperature
- Fast Switching
- Fully Avalanche Rated
- Optimized for SMPS Applications
- Lead-Free

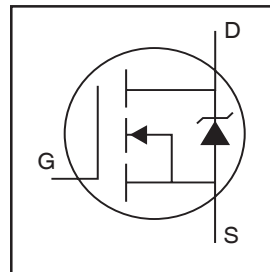

| |
|--------------------------------|
| $V_{DSS} = 60V$ |
| $R_{DS(on)} = 9.0m\Omega$ |
| $I_D = 115A^{\textcircled{3}}$ |

Description

Advanced HEXFET® Power MOSFETs from International Rectifier utilize advanced processing techniques to achieve extremely low on-resistance per silicon area. This benefit, combined with the fast switching speed and ruggedized device design that HEXFET power MOSFETs are well known for, provides the designer with an extremely efficient and reliable device for use in a wide variety of applications.

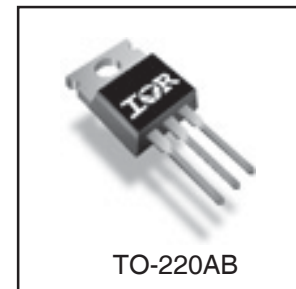

Absolute Maximum Ratings

| | Parameter | Max. | Units |
|---------------------------|--|--------------------|-------|
| $I_D @ T_C = 25^\circ C$ | Continuous Drain Current, $V_{GS} @ 10V$ | 115 ^③ | A |
| $I_D @ T_C = 100^\circ C$ | Continuous Drain Current, $V_{GS} @ 10V$ | 81 | |
| I_{DM} | Pulsed Drain Current ① ⑦ | 360 | |
| $P_D @ T_C = 25^\circ C$ | Power Dissipation | 270 | W |
| | Linear Derating Factor | 1.8 | W/°C |
| V_{GS} | Gate-to-Source Voltage | ± 20 | V |
| I_{AR} | Avalanche Current ① | 85 | A |
| E_{AR} | Repetitive Avalanche Energy ① | 18 | mJ |
| dv/dt | Peak Diode Recovery dv/dt ③ ⑦ | 4.7 | V/ns |
| T_J | Operating Junction and | -55 to + 175 | °C |
| T_{STG} | Storage Temperature Range | | |
| | Soldering Temperature, for 10 seconds | | |
| | Mounting torque, 6-32 or M3 screw | 10 lbf•in (1.1N•m) | |

Thermal Resistance

| | Parameter | Typ. | Max. | Units |
|-----------------|-------------------------------------|------|------|-------|
| $R_{\theta JC}$ | Junction-to-Case | — | 0.56 | °C/W |
| $R_{\theta CS}$ | Case-to-Sink, Flat, Greased Surface | 0.24 | — | |
| $R_{\theta JA}$ | Junction-to-Ambient | — | 40 | |

Electrical Characteristics @ T_J = 25°C (unless otherwise specified)

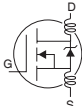
| | Parameter | Min. | Typ. | Max. | Units | Conditions |
|--------------------------------------|--------------------------------------|------|-------|------|-------|--|
| V _{(BR)DSS} | Drain-to-Source Breakdown Voltage | 60 | — | — | V | V _{GS} = 0V, I _D = 250μA |
| ΔV _{(BR)DSS/ΔT_J} | Breakdown Voltage Temp. Coefficient | — | 0.066 | — | V/°C | Reference to 25°C, I _D = 1mA |
| R _{DS(on)} | Static Drain-to-Source On-Resistance | — | — | 9.0 | mΩ | V _{GS} = 10V, I _D = 54A ④⑦ |
| V _{GS(th)} | Gate Threshold Voltage | 2.0 | — | 4.0 | V | V _{DS} = V _{GS} , I _D = 250μA |
| g _{fs} | Forward Transconductance | 61 | — | — | S | V _{DS} = 25V, I _D = 54A④⑦ |
| I _{DSS} | Drain-to-Source Leakage Current | — | — | 25 | μA | V _{DS} = 60V, V _{GS} = 0V |
| | | — | — | 250 | | V _{DS} = 48V, V _{GS} = 0V, T _J = 150°C |
| I _{GSS} | Gate-to-Source Forward Leakage | — | — | 100 | nA | V _{GS} = 20V |
| | Gate-to-Source Reverse Leakage | — | — | -100 | | V _{GS} = -20V |
| Q _g | Total Gate Charge | — | — | 170 | nC | I _D = 64A |
| Q _{gs} | Gate-to-Source Charge | — | — | 39 | | V _{DS} = 48V |
| Q _{gd} | Gate-to-Drain ("Miller") Charge | — | — | 59 | | V _{GS} = 10V, See Fig. 6 and 13⑦ |
| t _{d(on)} | Turn-On Delay Time | — | 22 | — | ns | V _{DD} = 30V |
| t _r | Rise Time | — | 160 | — | | I _D = 64A |
| t _{d(off)} | Turn-Off Delay Time | — | 77 | — | | R _G = 6.2Ω |
| t _f | Fall Time | — | 110 | — | | V _{GS} = 10V, See Fig. 10 ④⑦ |
| L _D | Internal Drain Inductance | — | 4.5 | — | nH | Between lead, 6mm (0.25in.) from package and center of die contact |
| L _S | Internal Source Inductance | — | 7.5 | — | |  |
| C _{iss} | Input Capacitance | — | 4080 | — | pF | V _{GS} = 0V |
| C _{oss} | Output Capacitance | — | 840 | — | | V _{DS} = 25V |
| C _{rss} | Reverse Transfer Capacitance | — | 180 | — | | f = 1.0MHz, See Fig. 5⑦ |
| E _{AS} | Single Pulse Avalanche Energy② | — | 1080③ | 220⑥ | | mJ |

Source-Drain Ratings and Characteristics

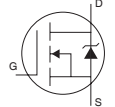
| | Parameter | Min. | Typ. | Max. | Units | Conditions |
|-----------------|---|--|------|------|-------|--|
| I _S | Continuous Source Current (Body Diode) | — | — | 115⑧ | A | MOSFET symbol showing the integral reverse p-n junction diode.  |
| I _{SM} | Pulsed Source Current (Body Diode)① | — | — | 360 | | |
| V _{SD} | Diode Forward Voltage | — | — | 1.2 | V | T _J = 25°C, I _S = 90A, V _{GS} = 0V ④⑦ |
| t _{rr} | Reverse Recovery Time | — | 78 | 120 | ns | T _J = 25°C, I _F = 64A |
| Q _{rr} | Reverse Recovery Charge | — | 250 | 380 | nC | di/dt = 100A/μs ④⑦ |
| t _{on} | Forward Turn-On Time | Intrinsic turn-on time is negligible (turn-on is dominated by L _S +L _D) | | | | |

Notes:

- ① Repetitive rating; pulse width limited by max. junction temperature. (See fig. 11)
- ② Starting T_J = 25°C, L = 60μH
R_G = 25Ω, I_{AS} = 85A, V_{GS} = 10V (See Figure 12)
- ③ I_{SD} ≤ 90A, di/dt ≤ 250A/μs, V_{DD} ≤ V_{(BR)DSS},
T_J ≤ 175°C
- ④ Pulse width ≤ 400μs; duty cycle ≤ 2%.
- ⑤ This is a typical value at device destruction and represents operation outside rated limits.
- ⑥ This is a calculated value limited to T_J = 175°C.
- ⑦ This is tested with same test conditions as the existing data sheet
- ⑧ Calculated continuous current based on maximum allowable junction temperature. Package limitation current is 75A.

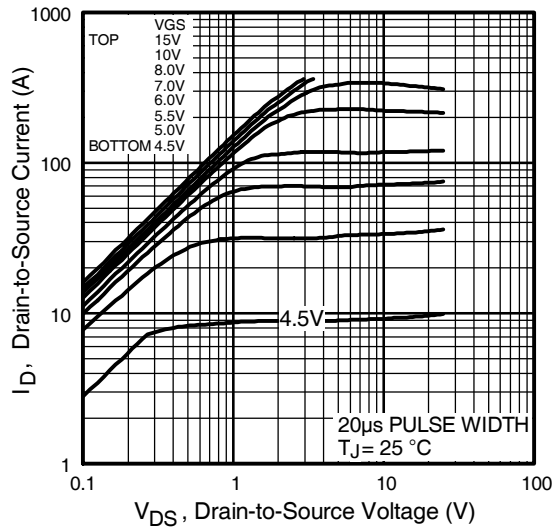

Fig 1. Typical Output Characteristics

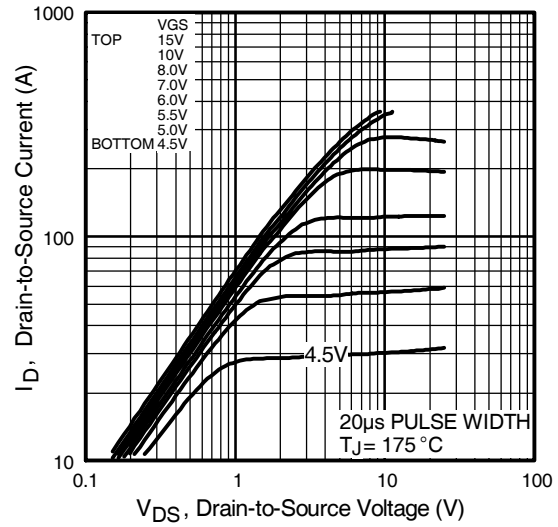

Fig 2. Typical Output Characteristics

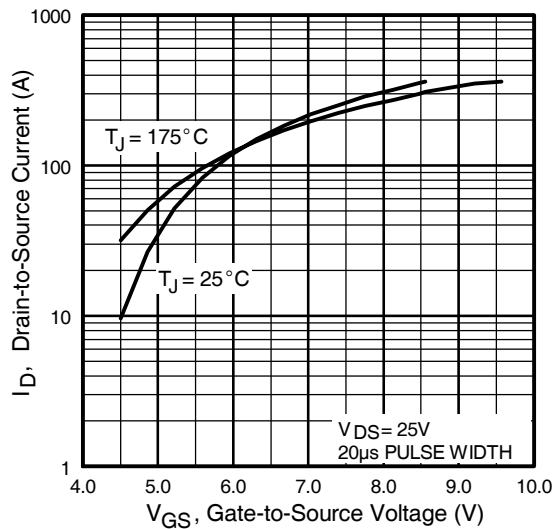

Fig 3. Typical Transfer Characteristics

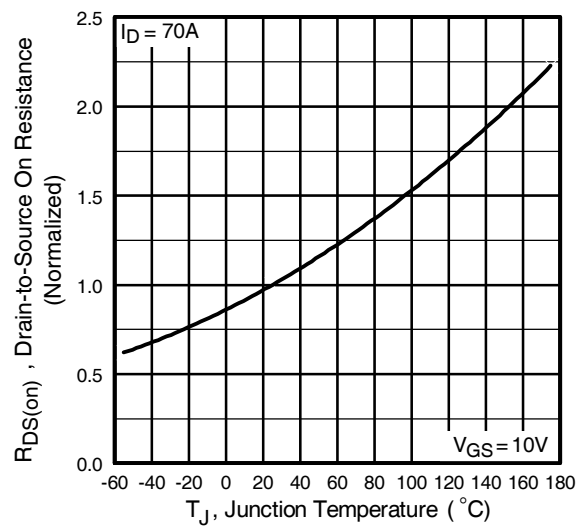

Fig 4. Normalized On-Resistance Vs. Temperature

IRFB4215PbF

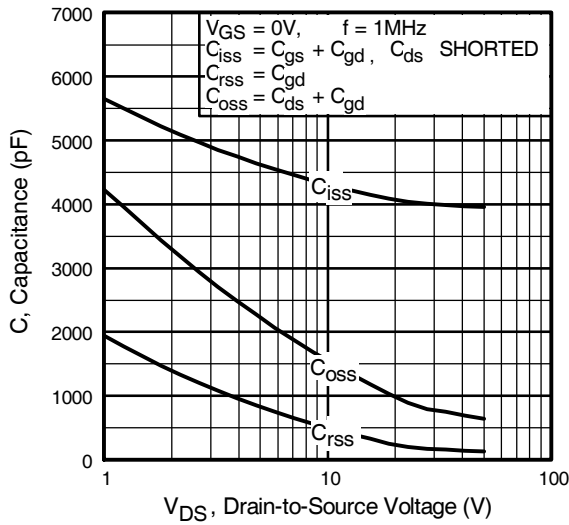

Fig 5. Typical Capacitance Vs. Drain-to-Source Voltage

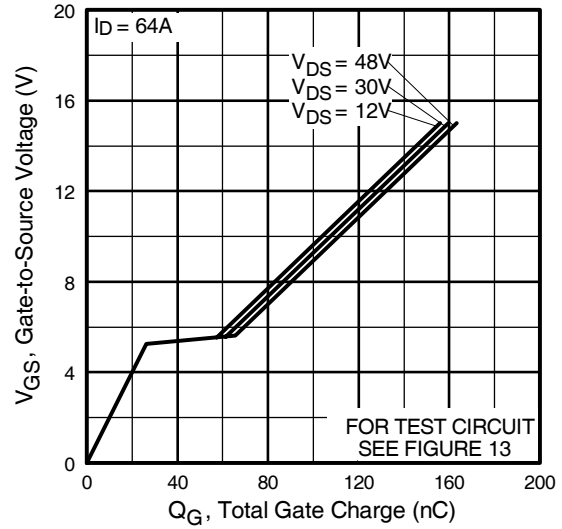

Fig 6. Typical Gate Charge Vs. Gate-to-Source Voltage

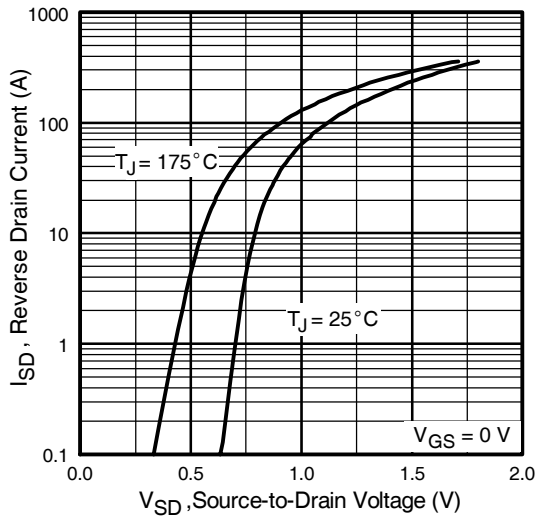

Fig 7. Typical Source-Drain Diode Forward Voltage

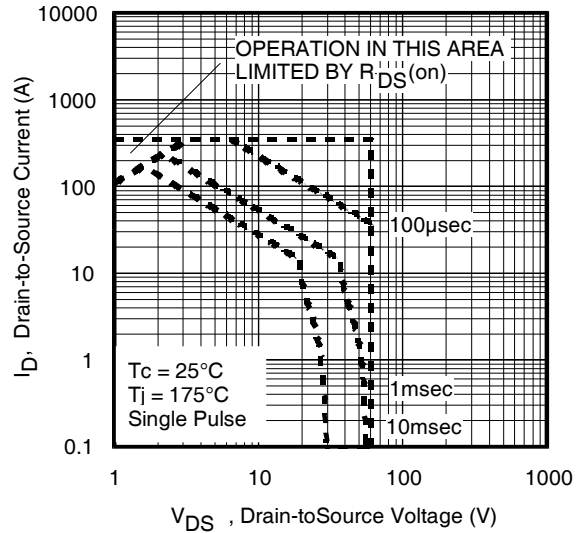

Fig 8. Maximum Safe Operating Area

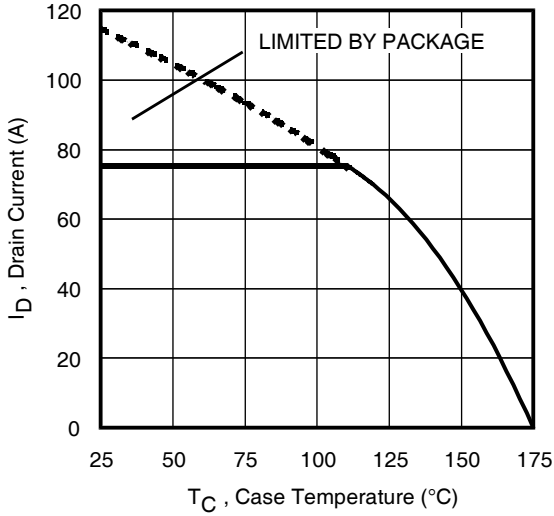

Fig 9. Maximum Drain Current Vs. Case Temperature

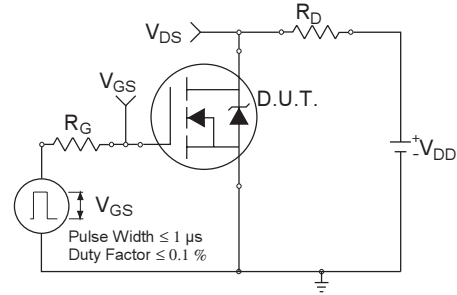

Fig 10a. Switching Time Test Circuit



Fig 10b. Switching Time Waveforms

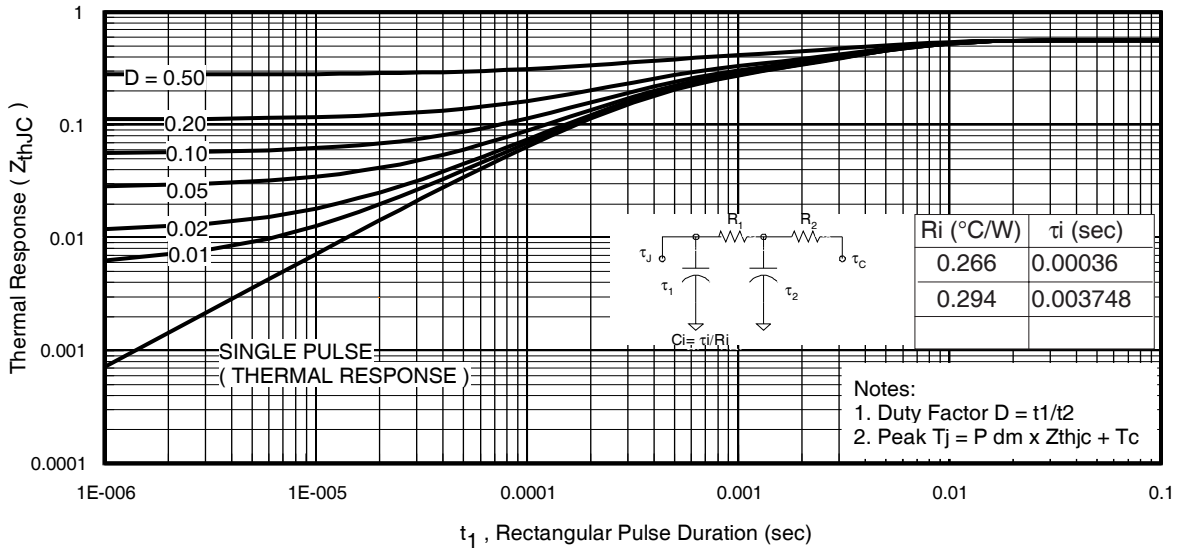

Fig 11. Maximum Effective Transient Thermal Impedance, Junction-to-Case

IRFB4215PbF

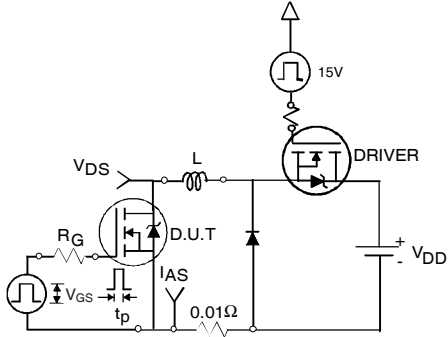

Fig 12a. Unclamped Inductive Test Circuit



Fig 12b. Unclamped Inductive Waveforms

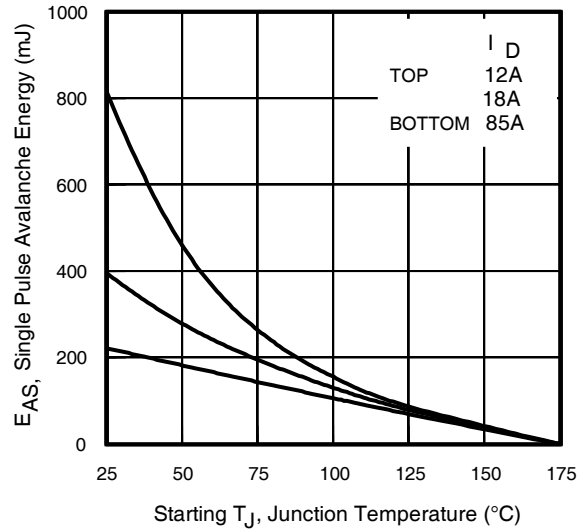

Fig 12c. Maximum Avalanche Energy Vs. Drain Current

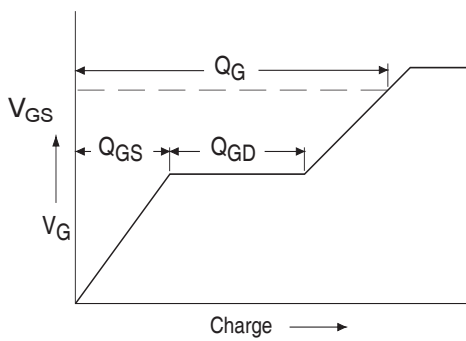

Fig 13a. Basic Gate Charge Waveform

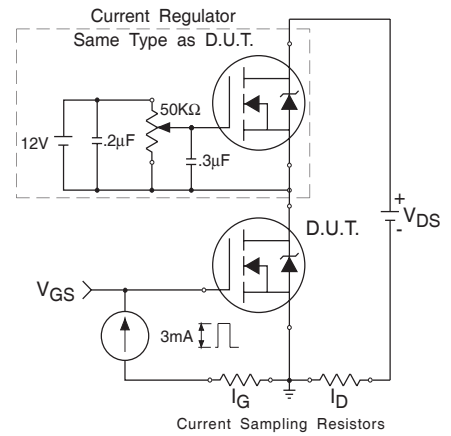
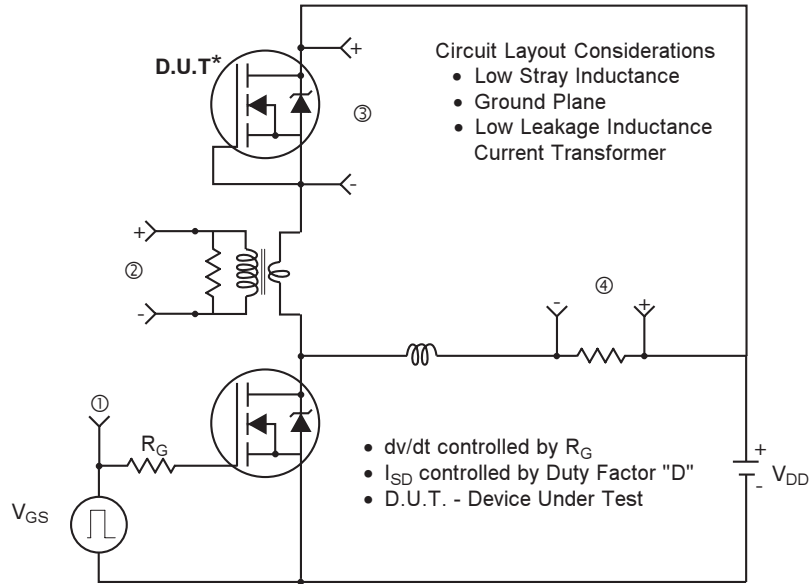

Fig 13b. Gate Charge Test Circuit

Peak Diode Recovery dv/dt Test Circuit



* Reverse Polarity of D.U.T for P-Channel



*** $V_{GS} = 5.0V$ for Logic Level and 3V Drive Devices

Fig 14. For N-channel HEXFET® power MOSFETs

IRFB4215PbF

TO-220AB Package Outline

Dimensions are shown in millimeters (inches)

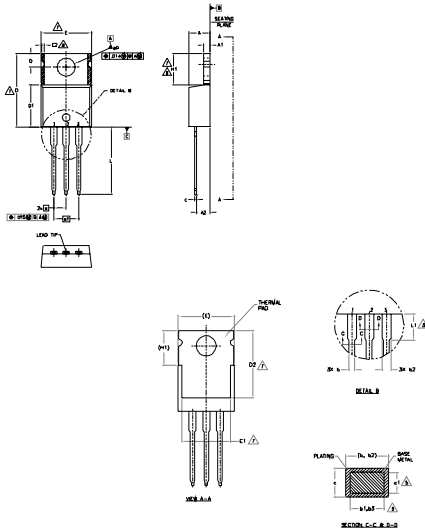

- NOTES:
- 1.- DIMENSIONING AND TOLERANCING AS PER ASME Y14.5 M- 1994.
 - 2.- DIMENSIONS ARE SHOWN IN INCHES [MILLIMETERS].
 - 3.- LEAD DIMENSION AND FINISH UNCONTROLLED IN L1.
 - 4.- DIMENSION D, D1 & E DO NOT INCLUDE MOLD FLASH. MOLD FLASH SHALL NOT EXCEED .005" (0.127) PER SIDE. THESE DIMENSIONS ARE MEASURED AT THE OUTERMOST EXTREMES OF THE PLASTIC BODY.
 - 5.- DIMENSION b1, b3 & c1 APPLY TO BASE METAL ONLY.
 - 6.- CONTROLLING DIMENSION - INCHES.
 - 7.- THERMAL PAD CONTOUR OPTIONAL. WITHIN DIMENSIONS E1, D2 & E1.
 - 8.- DIMENSION E2 X H1 DEFINE A ZONE WHERE STAMPING AND SINGULATION IRREGULARITIES ARE ALLOWED.
 - 9.- OUTLINE CONFORMS TO JEDEC TO-220, EXCEPT A2 (max.) AND D2 (min.) WHERE DIMENSIONS ARE DERIVED FROM THE ACTUAL PACKAGE OUTLINE.

| SYMBOL | DIMENSIONS | | | | NOTES |
|--------|-------------|-------|----------|------|-------|
| | MILLIMETERS | | INCHES | | |
| | MIN. | MAX. | MIN. | MAX. | |
| A | 3.56 | 4.83 | .140 | .190 | |
| A1 | 0.51 | 1.40 | .020 | .055 | |
| A2 | 2.03 | 2.92 | .080 | .115 | |
| b | 0.38 | 1.01 | .015 | .040 | 5 |
| b1 | 0.38 | 0.97 | .015 | .038 | |
| b2 | 1.14 | 1.78 | .045 | .070 | |
| b3 | 1.14 | 1.73 | .045 | .068 | 5 |
| c | 0.36 | 0.61 | .014 | .024 | |
| c1 | 0.36 | 0.56 | .014 | .022 | 5 |
| D | 14.22 | 16.51 | .560 | .650 | 4 |
| D1 | 8.38 | 9.02 | .330 | .355 | |
| D2 | 11.68 | 12.88 | .460 | .507 | 7 |
| E | 9.65 | 10.67 | .380 | .420 | 4,7 |
| E1 | 6.86 | 8.89 | .270 | .350 | 7 |
| E2 | - | 0.76 | - | .030 | 8 |
| e | 7.54 BSC | | .100 BSC | | |
| e1 | 5.08 BSC | | .200 BSC | | |
| H1 | 5.84 | 6.86 | .230 | .270 | 7,8 |
| L | 12.70 | 14.73 | .500 | .580 | |
| L1 | 3.56 | 4.06 | .140 | .160 | 3 |
| øP | 3.54 | 4.08 | .139 | .161 | |
| Q | 2.54 | 3.42 | .100 | .135 | |

- LEAD ASSIGNMENTS
- HEXITE
- 1- GATE
 - 2- DRAIN
 - 3- SOURCE
- ISBTL COPOLY
- 1- GATE
 - 2- COLLECTOR
 - 3- EMITTER
- DOCKES
- 1- ANODE
 - 2- CATHODE
 - 3- ANODE

TO-220AB Part Marking Information

EXAMPLE: THIS IS AN IRF1010
 LOT CODE 1789
 ASSEMBLED ON WW 19, 1997
 IN THE ASSEMBLY LINE "C"

Note: "P" in assembly line position
 indicates "Lead-Free"

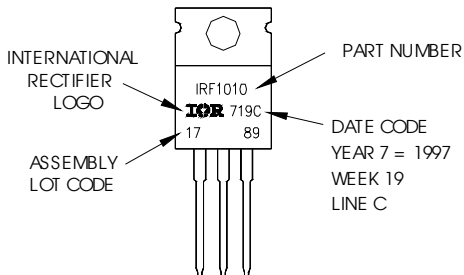

TO-220AB packages are not recommended for Surface Mount Application.

Notes:

1. For an Automotive Qualified version of this part please see <http://www.irf.com/product-info/auto/>
2. For the most current drawing please refer to IR website at <http://www.irf.com/package/>

Data and specifications subject to change without notice.
 This product has been designed and qualified for the Industrial market.
 Qualification Standards can be found on IR's Web site.



IR WORLD HEADQUARTERS: 233 Kansas St., El Segundo, California 90245, USA Tel: (310) 252-7105
 TAC Fax: (310) 252-7903

Visit us at www.irf.com for sales contact information. 09/2010

www.irf.com