

**0.7A, 100V, 1.200 Ohm, P-Channel Power MOSFET**

This P-Channel enhancement mode silicon gate power field effect transistor is an advanced power MOSFET designed, tested, and guaranteed to withstand a specified level of energy in the breakdown avalanche mode of operation. All of these power MOSFETs are designed for applications such as switching regulators, switching convertors, motor drivers, relay drivers, and drivers for high power bipolar switching transistors requiring high speed and low gate drive power. These types can be operated directly from integrated circuits.

Formerly developmental type TA17541.

**Ordering Information**

PART NUMBER	PACKAGE	BRAND
IRFD9110	HEXDIP	IRFD9110

NOTE: When ordering, use the entire part number.

**Features**

- 0.7A, 100V
- $r_{DS(ON)} = 1.200\Omega$
- Single Pulse Avalanche Energy Rated
- SOA is Power Dissipation Limited
- Nanosecond Switching Speeds
- Linear Transfer Characteristics
- High Input Impedance

**Symbol**

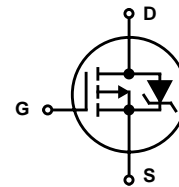

**Packaging**

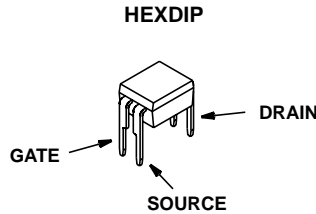

# IRFD9110

## Absolute Maximum Ratings $T_C = 25^\circ\text{C}$ , Unless Otherwise Specified

	IRFD9110	UNITS
Drain to Source Breakdown Voltage (Note 1) . . . . .	-100	V
Drain to Gate Voltage ( $R_{GS} = 20k\Omega$ ) (Note 1) . . . . .	-100	V
Continuous Drain Current . . . . .	-0.7	A
Pulsed Drain Current . . . . .	-3.0	A
Gate to Source Voltage . . . . .	$\pm 20$	V
Maximum Power Dissipation (Figure 1) . . . . .	1.0	W
Dissipation Derating Factor (Figure 1) . . . . .	0.008	W/ $^\circ\text{C}$
Single Pulse Avalanche Energy Rating (Note 3) . . . . .	190	mJ
Operating and Storage Temperature . . . . .	-55 to 150	$^\circ\text{C}$
Maximum Temperature for Soldering		
Leads at 0.063in (1.6mm) from Case for 10s. . . . .	300	$^\circ\text{C}$
Package Body for 10s, See Techbrief 334 . . . . .	260	$^\circ\text{C}$

CAUTION: Stresses above those listed in "Absolute Maximum Ratings" may cause permanent damage to the device. This is a stress only rating and operation of the device at these or any other conditions above those indicated in the operational sections of this specification is not implied.

**NOTE:**

1.  $T_J = 25^\circ\text{C}$  to  $125^\circ\text{C}$ .

## Electrical Specifications $T_C = 25^\circ\text{C}$ , Unless Otherwise Specified

PARAMETER	SYMBOL	TEST CONDITIONS	MIN	TYP	MAX	UNITS
Drain to Source Breakdown Voltage	$BV_{DSS}$	$I_D = -250\mu\text{A}$ , $V_{GS} = 0\text{V}$ , (Figure 9)	-100	-	-	V
Gate Threshold Voltage	$V_{GS(TH)}$	$V_{GS} = V_{DS}$ , $I_D = -250\mu\text{A}$	-2	-	-4	V
Zero Gate Voltage Drain Current	$I_{DSS}$	$V_{DS} = \text{Rated } BV_{DSS}$ , $V_{GS} = 0\text{V}$	-	-	-25	$\mu\text{A}$
		$V_{DS} = 0.8 \times \text{Rated } BV_{DSS}$ , $V_{GS} = 0\text{V}$ , $T_C = 125^\circ\text{C}$	-	-	-250	$\mu\text{A}$
On-State Drain Current (Note 2)	$I_{D(ON)}$	$V_{DS} > I_{D(ON)} \times r_{DS(ON)MAX}$ , $V_{GS} = -10\text{V}$ , (Figure 6)	-0.7	-	-	A
Gate to Source Leakage Current	$I_{GSS}$	$V_{GS} = \pm 20\text{V}$	-	-	$\pm 100$	nA
Drain to Source On Resistance (Note 2)	$r_{DS(ON)}$	$I_D = -0.3\text{A}$ , $V_{GS} = -10\text{V}$ , (Figures 8)	-	1.000	1.200	$\Omega$
Forward Transconductance (Note 2)	$g_{fs}$	$V_{DS} \leq 50\text{V}$ , $I_D = -0.6\text{A}$ , (Figure 11)	0.59	0.88	-	S
Turn-On Delay Time	$t_{d(ON)}$	$V_{DD} = 0.5 \times \text{Rated } BV_{DSS}$ , $I_D = -0.7\text{A}$ , $R_G = 9.1\Omega$ , $V_{GS} = -10\text{V}$ , (Figures 16, 17), $R_L = 70\Omega$ for $V_{DSS} = 50\text{V}$ , $R_L = 56\Omega$ for $V_{DSS} = 40\text{V}$ MOSFET Switching Times are Essentially Independent of Operating Temperature	-	15	30	ns
Rise Time	$t_r$		-	30	60	ns
Turn-Off Delay Time	$t_{d(OFF)}$		-	20	40	ns
Fall Time	$t_f$		-	20	40	ns
Total Gate Charge (Gate to Source + Gate to Drain)	$Q_{g(TOT)}$	$V_{GS} = -10\text{V}$ , $I_D = -0.7\text{A}$ , $V_{DS} = 0.8 \times \text{Rated } BV_{DSS}$ , (Figures 13, 18, 19) Gate Charge is Essentially Independent of Operating Temperature	-	11	15	nC
Gate to Source Charge	$Q_{gs}$		-	5.7	-	nC
Gate to Drain "Miller" Charge	$Q_{gd}$		-	5.3	-	nC
Input Capacitance	$C_{ISS}$	$V_{DS} = -25\text{V}$ , $V_{GS} = 0\text{V}$ , $f = 1\text{MHz}$ , (Figure 10)	-	180	-	pF
Output Capacitance	$C_{OSS}$		-	85	-	pF
Reverse Transfer Capacitance	$C_{RSS}$		-	30	-	pF
Internal Drain Inductance	$L_D$	Measured From the Drain Lead, 2mm (0.08in) From Package to Center of Die	-	4.0	-	nH
Internal Source Inductance	$L_S$	Measured From the Source Lead, 2mm (0.08in) From Header to Source Bonding Pad	-	6.0	-	nH
Thermal Resistance Junction to Ambient	$R_{\theta JA}$	Typical Socket Mount	-	-	120	$^\circ\text{C/W}$

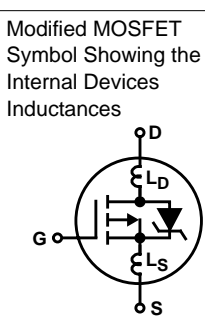

Source to Drain Diode Specifications

PARAMETER	SYMBOL	TEST CONDITIONS	MIN	TYP	MAX	UNITS
Continuous Source to Drain Current	$I_{SD}$	Modified MOSFET Symbol Showing the Integral Reverse P-N Junction Diode	-	-	-0.7	A
Pulse Source to Drain Current (Note 3)	$I_{SDM}$		-	-	-3.0	A
Source to Drain Diode Voltage (Note 2)	$V_{SD}$	$T_J = 25^{\circ}\text{C}$ , $I_{SD} = -0.7\text{A}$ , $V_{GS} = 0\text{V}$ , (Figure 12)	-	-	-1.5	V
Reverse Recovery Time	$t_{rr}$	$T_J = 150^{\circ}\text{C}$ , $I_{SD} = -0.7\text{A}$ , $dI_{SD}/dt = 100\text{A}/\mu\text{s}$	-	120	-	ns
Reverse Recovery Charge	$Q_{RR}$	$T_J = 150^{\circ}\text{C}$ , $I_{SD} = -0.7\text{A}$ , $dI_{SD}/dt = 100\text{A}/\mu\text{s}$	-	6.0	-	$\mu\text{C}$

NOTES:

2. Pulse test: pulse width  $\leq 300\mu\text{s}$ , duty cycle  $\leq 2\%$ .
3.  $V_{DD} = 25\text{V}$ , starting  $T_J = 25^{\circ}\text{C}$ ,  $L = 582\text{mH}$ ,  $R_G = 25\Omega$ , peak  $I_{AS} = 0.7\text{A}$ . See Figures 14, 15.

Typical Performance Curves Unless Otherwise Specified

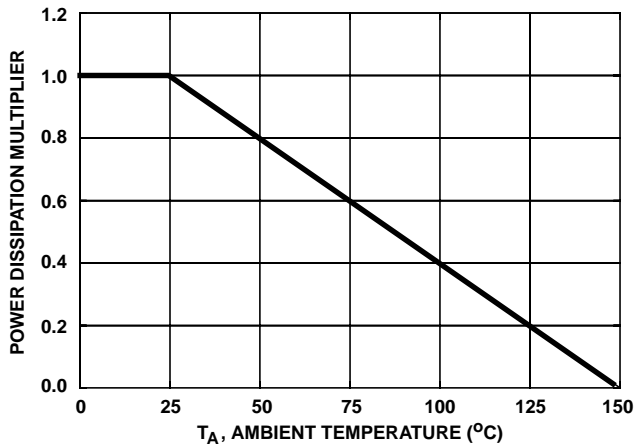

FIGURE 1. NORMALIZED POWER DISSIPATION vs AMBIENT TEMPERATURE

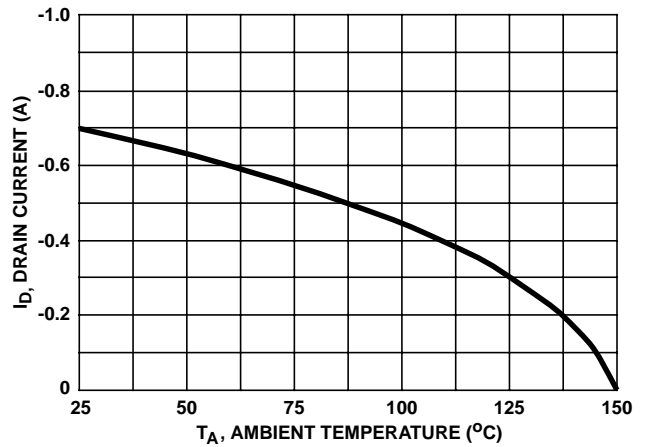

FIGURE 2. MAXIMUM CONTINUOUS DRAIN CURRENT vs AMBIENT TEMPERATURE

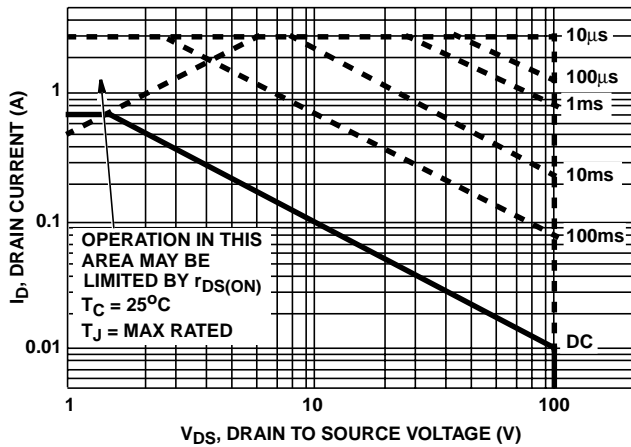

FIGURE 3. FORWARD BIAS SAFE OPERATING AREA

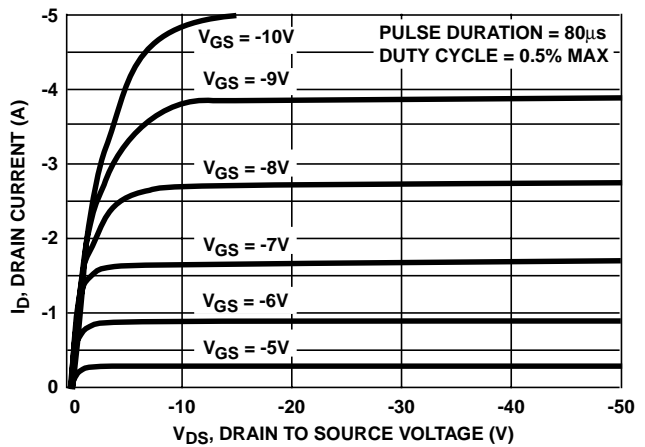

FIGURE 4. OUTPUT CHARACTERISTICS

Typical Performance Curves Unless Otherwise Specified (Continued)

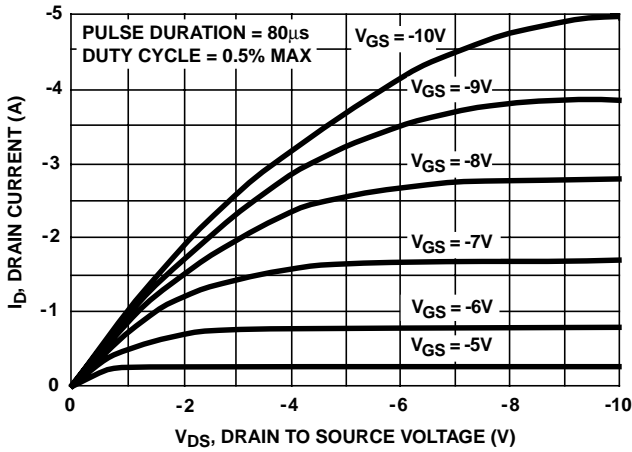

FIGURE 5. SATURATION CHARACTERISTICS

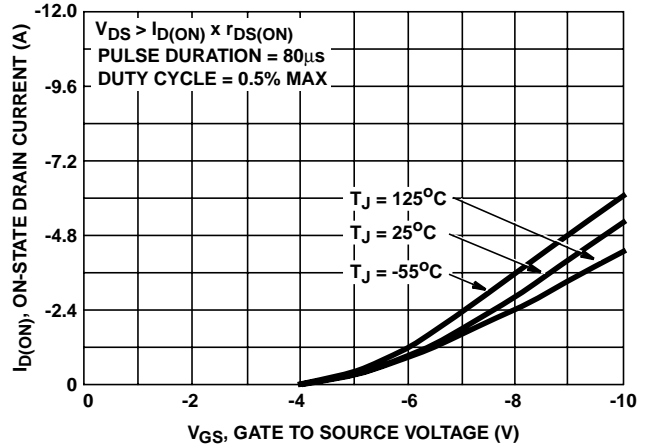
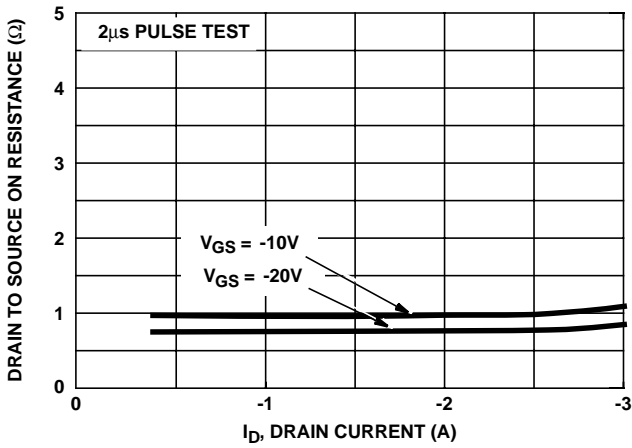

FIGURE 6. TRANSFER CHARACTERISTICS



NOTE: Heating effect of 2µs is minimal.

FIGURE 7. DRAIN TO SOURCE ON RESISTANCE vs GATE VOLTAGE AND DRAIN CURRENT

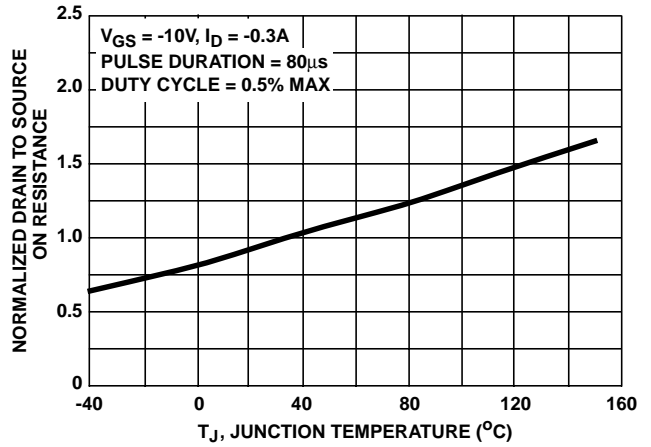

FIGURE 8. NORMALIZED DRAIN TO SOURCE ON RESISTANCE vs JUNCTION TEMPERATURE

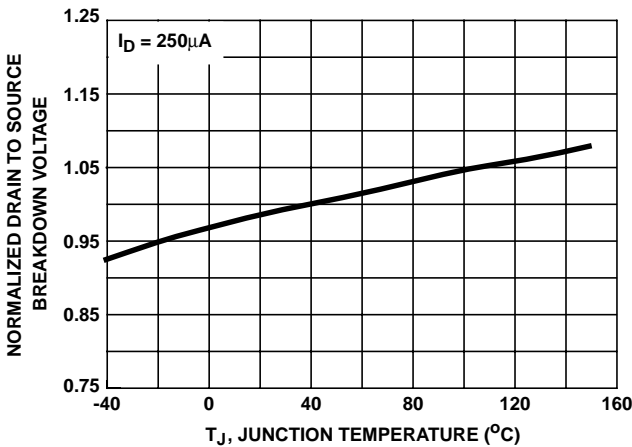

FIGURE 9. NORMALIZED DRAIN TO SOURCE BREAKDOWN VOLTAGE vs JUNCTION TEMPERATURE

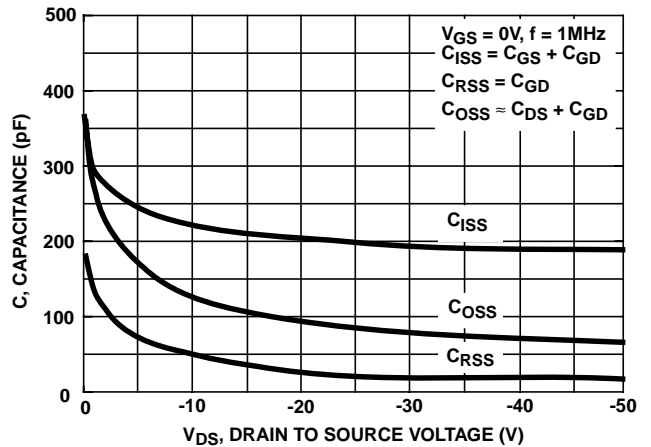

FIGURE 10. CAPACITANCE vs DRAIN TO SOURCE VOLTAGE

**Typical Performance Curves** Unless Otherwise Specified (Continued)

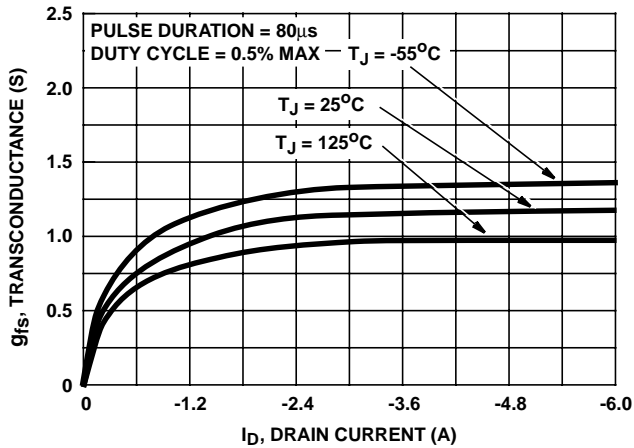

FIGURE 11. TRANSCONDUCTANCE vs DRAIN CURRENT

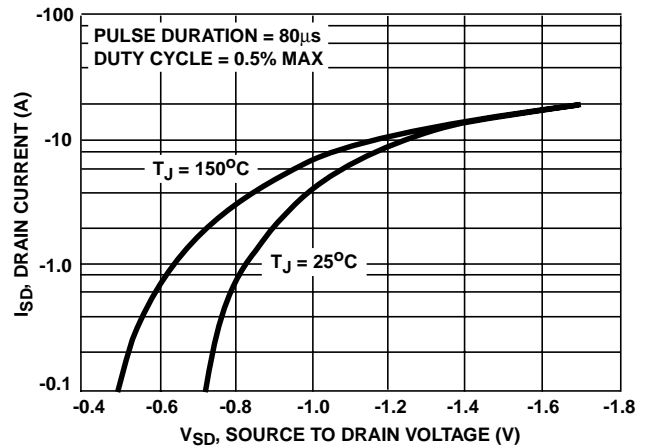

FIGURE 12. SOURCE TO DRAIN DIODE VOLTAGE

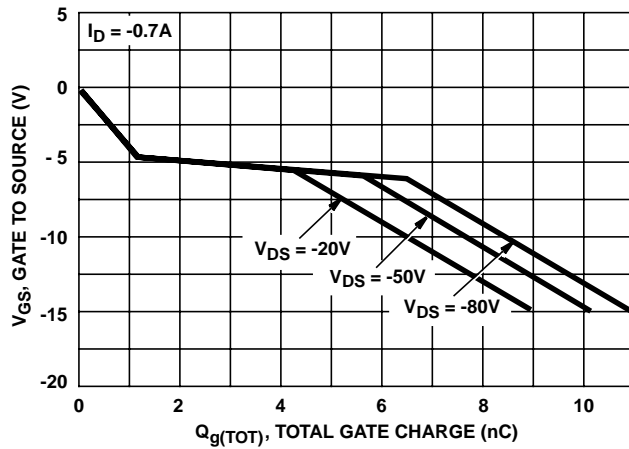

FIGURE 13. GATE TO SOURCE VOLTAGE vs GATE CHARGE

**Test Circuits and Waveforms**

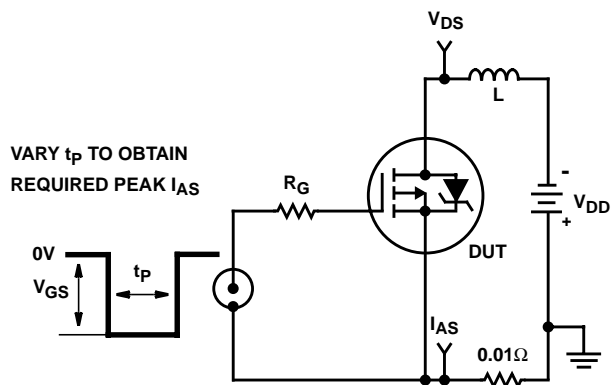

FIGURE 14. UNCLAMPED ENERGY TEST CIRCUIT

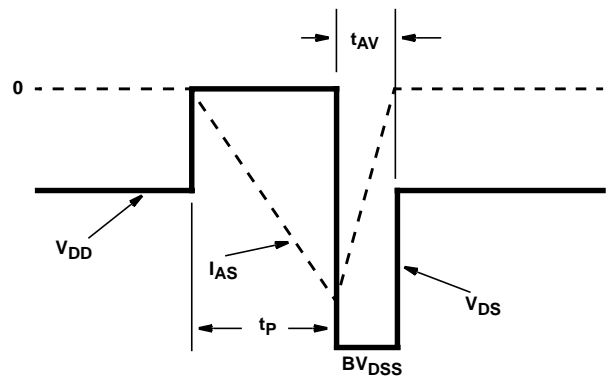

FIGURE 15. UNCLAMPED ENERGY WAVEFORMS

Test Circuits and Waveforms (Continued)

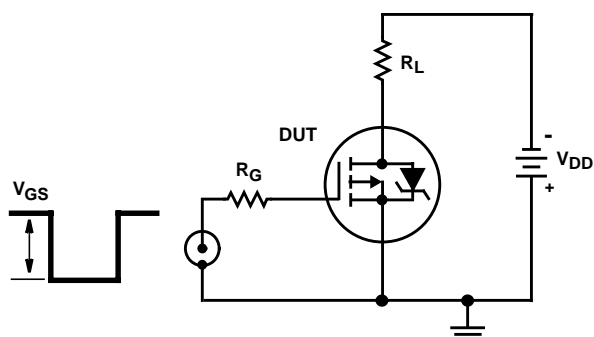

FIGURE 16. SWITCHING TIME TEST CIRCUIT

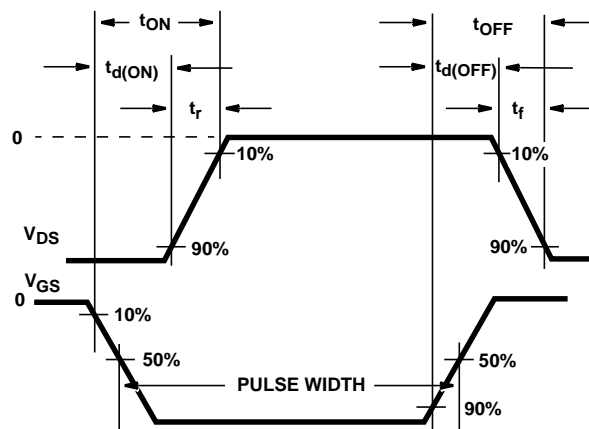

FIGURE 17. RESISTIVE SWITCHING WAVEFORMS

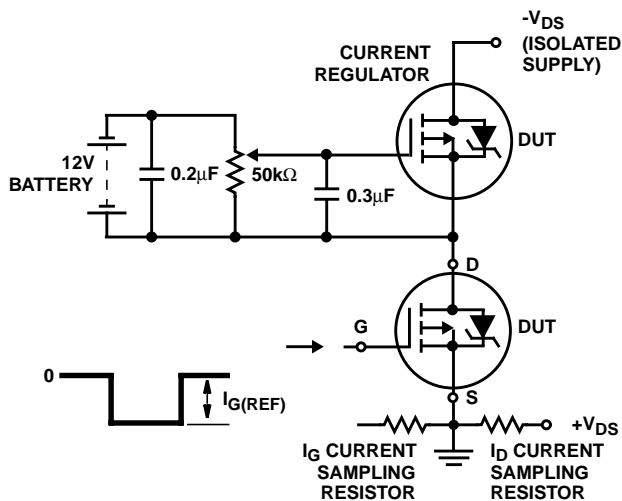

FIGURE 18. GATE CHARGE TEST CIRCUIT

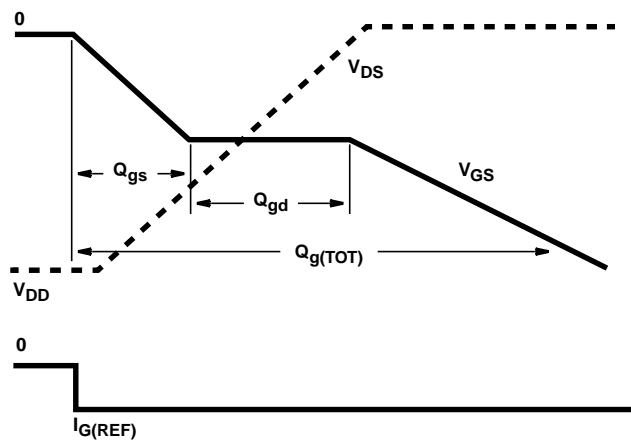

FIGURE 19. GATE CHARGE WAVEFORMS

All Intersil semiconductor products are manufactured, assembled and tested under **ISO9000** quality systems certification.

*Intersil semiconductor products are sold by description only. Intersil Corporation reserves the right to make changes in circuit design and/or specifications at any time without notice. Accordingly, the reader is cautioned to verify that data sheets are current before placing orders. Information furnished by Intersil is believed to be accurate and reliable. However, no responsibility is assumed by Intersil or its subsidiaries for its use; nor for any infringements of patents or other rights of third parties which may result from its use. No license is granted by implication or otherwise under any patent or patent rights of Intersil or its subsidiaries.*

For information regarding Intersil Corporation and its products, see web site <http://www.intersil.com>

**Sales Office Headquarters**

**NORTH AMERICA**  
Intersil Corporation  
P. O. Box 883, Mail Stop 53-204  
Melbourne, FL 32902  
TEL: (407) 724-7000  
FAX: (407) 724-7240

**EUROPE**  
Intersil SA  
Mercure Center  
100, Rue de la Fusee  
1130 Brussels, Belgium  
TEL: (32) 2.724.2111  
FAX: (32) 2.724.22.05

**ASIA**  
Intersil (Taiwan) Ltd.  
7F-6, No. 101 Fu Hsing North Road  
Taipei, Taiwan  
Republic of China  
TEL: (886) 2 2716 9310  
FAX: (886) 2 2715 3029