

International IR Rectifier

REPETITIVE AVALANCHE AND dv/dt RATED
HEXFET® TRANSISTOR

PD - 9.1718A

IRFE330
JANTX2N6800U
JANTXV2N6800U
[REF:MIL-PRF-19500/557]
N-CHANNEL

400Volt, 1.0Ω, HEXFET

The leadless chip carrier (LCC) package represents the logical next step in the continual evolution of surface mount technology. The LCC provides designers the extra flexibility they need to increase circuit board density. International Rectifier has engineered the LCC package to meet the specific needs of the power market by increasing the size of the bottom source pad, thereby enhancing the thermal and electrical performance. The lid of the package is grounded to the source to reduce RF interference.

HEXFET transistors also feature all of the well-established advantages of MOSFETs, such as voltage control, very fast switching, ease of paralleling and electrical parameter temperature stability. They are well-suited for applications such as switching power supplies, motor controls, inverters, choppers, audio amplifiers and high-energy pulse circuits, and virtually any application where high reliability is required.

Product Summary

| Part Number | BV _{ss} | R _{DS(on)} | I _D |
|-------------|------------------|---------------------|----------------|
| IRFE330 | 400V | 1.0Ω | 3.0A |

Features:

- Hermetically Sealed
- Simple Drive Requirements
- Ease of Paralleling
- Small footprint
- Surface Mount
- Lightweight

Absolute Maximum Ratings

| | Parameter | IRFE330, JANTX-, JANTXV-, 2N6800U | Units |
|---|---------------------------------|-----------------------------------|-------|
| I _D @ V _{GS} = -10V, T _C = 25°C | Continuous Drain Current | 3.0 | A |
| I _D @ V _{GS} = -10V, T _C = 100°C | Continuous Drain Current | 2.0 | |
| I _{DM} | Pulsed Drain Current ① | 12 | |
| P _D @ T _C = 25°C | Max. Power Dissipation | 25 | W |
| | Linear Derating Factor | 0.20 | W/K ⑤ |
| V _{GS} | Gate-to-Source Voltage | ±20 | V |
| EAS | Single Pulse Avalanche Energy ② | 0.51 | mJ |
| dv/dt | Peak Diode Recovery dv/dt ③ | 8.4 | V/ns |
| T _J | Operating Junction | -55 to 150 | °C |
| T _{STG} | Storage Temperature Range | | |
| | Surface Temperature | 300 (for 5 seconds) | |
| | Weight | 0.42 (typical) | g |

IRFE330, JANTX-, JANTXV-, 2N6800U Device

Electrical Characteristics @ T_J = 25°C (Unless Otherwise Specified)

| | Parameter | Min | Typ | Max | Units | Test Conditions |
|--|--|-----|------|-------------|--------|--|
| B _V D _{SS} | Drain-to-Source Breakdown Voltage | 400 | — | — | V | V _{GS} = 0 V, I _D = 1.0mA |
| ΔB _V D _{SS} /ΔT _J | Temperature Coefficient of Breakdown Voltage | — | 0.35 | — | V/°C | Reference to 25°C, I _D = 1.0mA |
| R _{DS(on)} | Static Drain-to-Source On-State Resistance | — | — | 1.0 1.15 | Ω | V _{GS} = 10V, I _D = 2.0A V _{GS} = 10V, I _D = 3.0A ④ |
| V _{GS(th)} | Gate Threshold Voltage | 2.0 | — | 4.0 | V | V _{DS} = V _{GS} , I _D = 250μA |
| g _{fs} | Forward Transconductance | 2.4 | — | — | S (r̄) | V _{DS} > 15V, I _{DS} = 2.0A ④ |
| I _{DSS} | Zero Gate Voltage Drain Current | — | — | 25 250 | μA | V _{DS} = 0.8 x Max Rating, V _{GS} = 0V V _{DS} = 0.8 x Max Rating V _{GS} = 0V, T _J = 125°C |
| I _{GSS} | Gate-to-Source Leakage Forward | — | — | 100 | nA | V _{GS} = 20 V |
| I _{GSS} | Gate-to-Source Leakage Reverse | — | — | -100 | nA | V _{GS} = -20V |
| Q _g | Total Gate Charge | — | — | 33 | nC | V _{GS} = 10V, I _D = 3.0A |
| Q _{gs} | Gate-to-Source Charge | — | — | 5.8 | nC | V _{DS} = Max Rating x 0.5 |
| Q _{gd} | Gate-to-Drain ('Miller') Charge | — | — | 17 | nC | |
| t _{d(on)} | Turn-On Delay Time | — | — | 30 | ns | V _{DD} = 200V, I _D = 3.0A, R _G = 7.5Ω |
| t _r | Rise Time | — | — | 35 | | |
| t _{d(off)} | Turn-Off Delay Time | — | — | 55 | | |
| t _f | Fall Time | — | — | 35 | | |
| L _D | Internal Drain Inductance | — | 1.8 | — | nH | Measured from drain pad to die. Modified MOSFET symbol showing the internal inductances.  |
| L _S | Internal Source Inductance | — | 4.3 | — | | |
| C _{iss} | Input Capacitance | — | 660 | — | pF | V _{GS} = 0V, V _{DS} = 25 V f = 1.0MHz |
| C _{oss} | Output Capacitance | — | 190 | — | | |
| C _{rss} | Reverse Transfer Capacitance | — | 68 | — | | |

Source-Drain Diode Ratings and Characteristics

| | Parameter | Min | Typ | Max | Units | Test Conditions |
|-----------------|--|--|-----|-----|-------|--|
| I _S | Continuous Source Current (Body Diode) | — | — | 3.0 | A | Modified MOSFET symbol showing the integral reverse p-n junction rectifier.  |
| I _{SM} | Pulse Source Current (Body Diode) ① | — | — | 12 | | |
| V _{SD} | Diode Forward Voltage | — | — | 1.4 | V | T _J = 25°C, I _S = 3.0A, V _{GS} = 0V ④ |
| t _{rr} | Reverse Recovery Time | — | — | 700 | ns | T _J = 25°C, I _F = 3.0A, di/dt ≤ 100A/μs |
| Q _{RR} | Reverse Recovery Charge | — | — | 6.2 | μC | V _{DD} ≤ 50V ④ |
| t _{on} | Forward Turn-On Time | Intrinsic turn-on time is negligible. Turn-on speed is substantially controlled by L _S + L _D . | | | | |

Thermal Resistance

| | Parameter | Min | Typ | Max | Units | Test Conditions |
|---------------------|----------------------|-----|-----|-----|-------|------------------------------------|
| R _{thJC} | Junction-to-Case | — | — | 5.0 | K/W ⑤ | |
| R _{thJPCB} | Junction-to-PC Board | — | — | 19 | | Soldered to a copper clad PC board |

Details of notes ① through ⑤ are on the last page

IRFE330, JANTX-, JANTXV-, 2N6800U Device

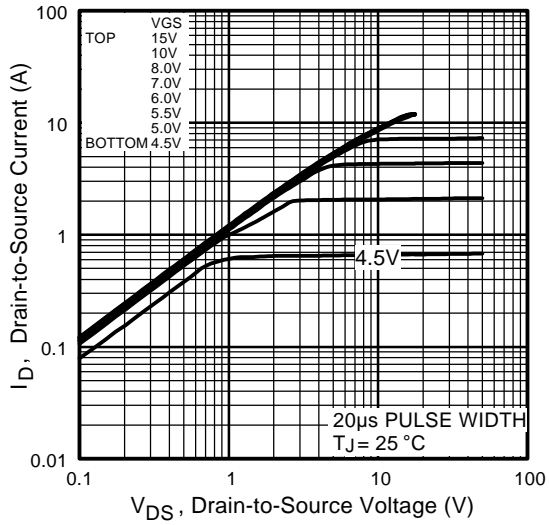

Fig 1. Typical Output Characteristics

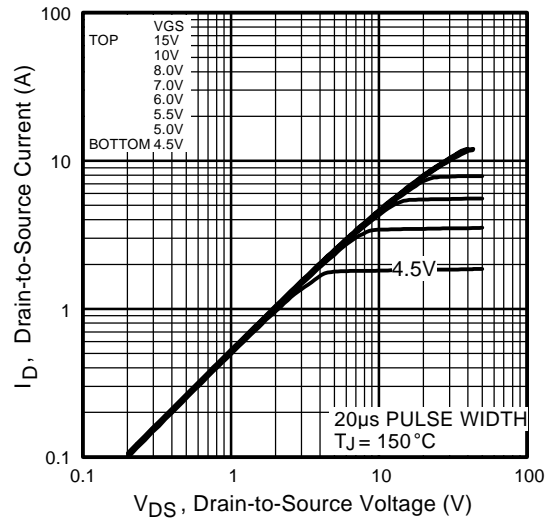

Fig 2. Typical Output Characteristics

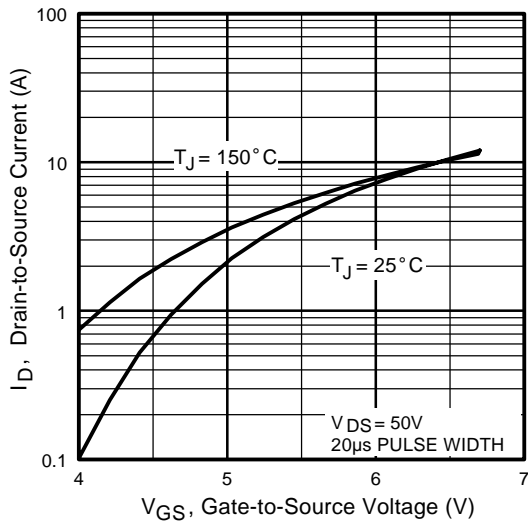

Fig 3. Typical Transfer Characteristics

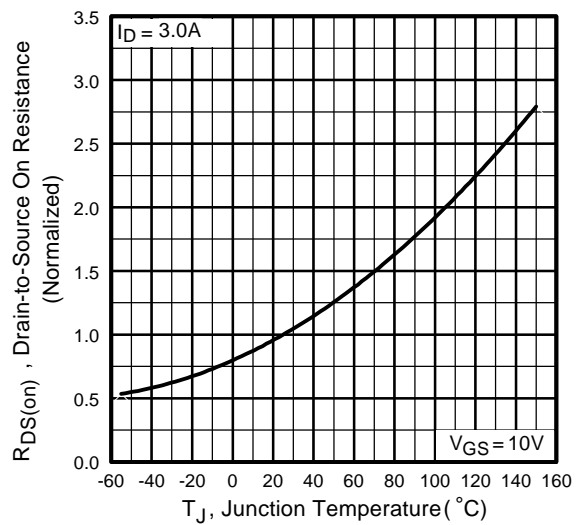

Fig 4. Normalized On-Resistance Vs. Temperature

IRFE330, JANTX-, JANTXV-, 2N6800U Device

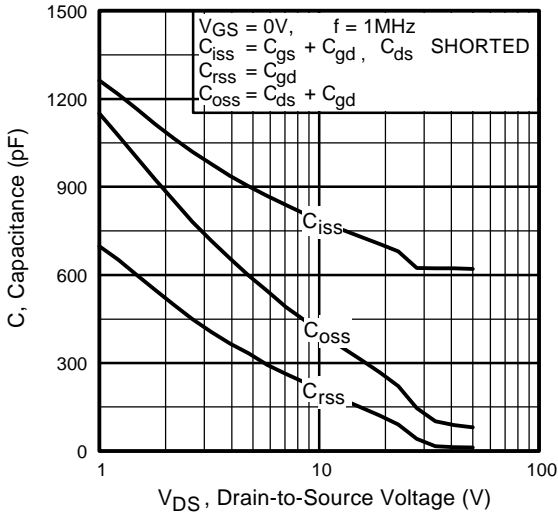

Fig 5. Typical Capacitance Vs. Drain-to-Source Voltage

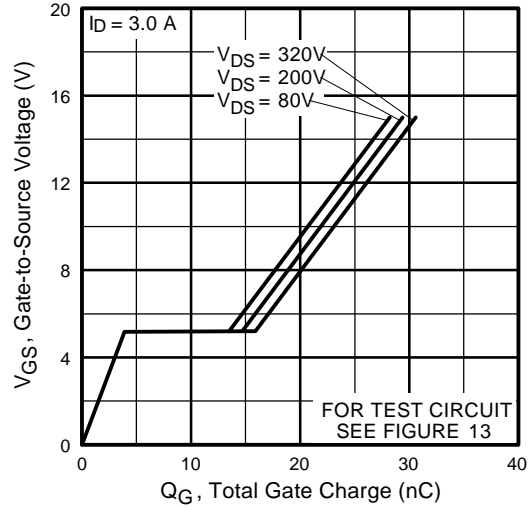

Fig 6. Typical Gate Charge Vs. Gate-to-Source Voltage

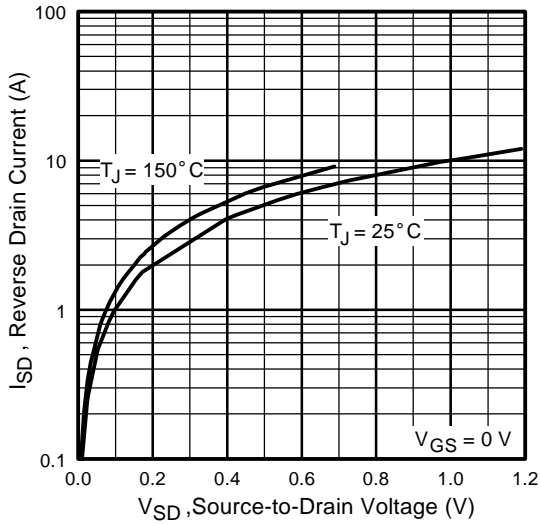

Fig 7. Typical Source-Drain Diode Forward Voltage

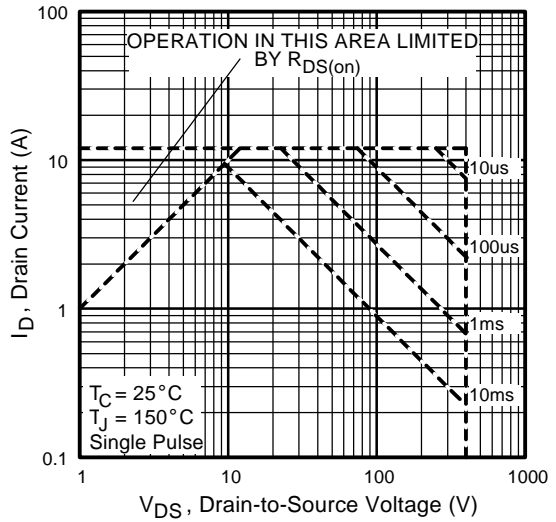

Fig 8. Maximum Safe Operating Area

IRFE330, JANTX-, JANTXV-, 2N6800U Device

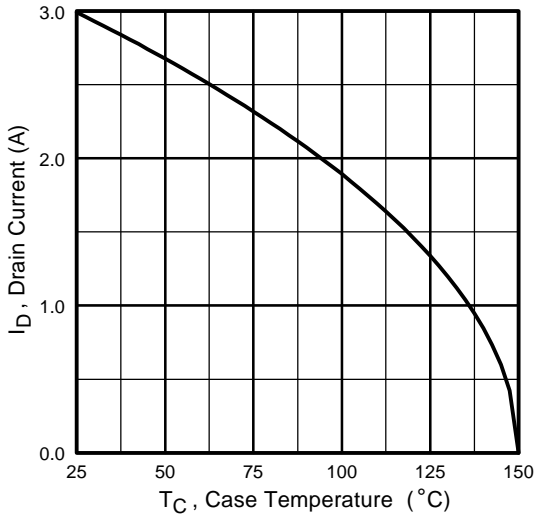

Fig 9. Maximum Drain Current Vs. Case Temperature

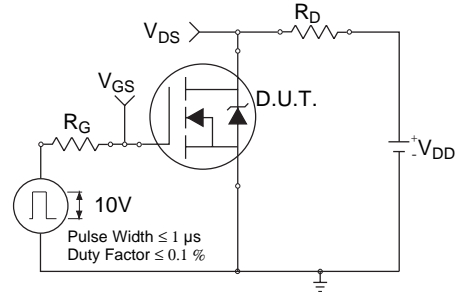

Fig 10a. Switching Time Test Circuit

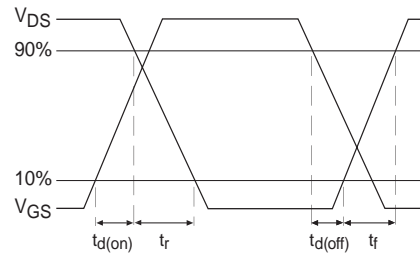

Fig 10b. Switching Time Waveforms

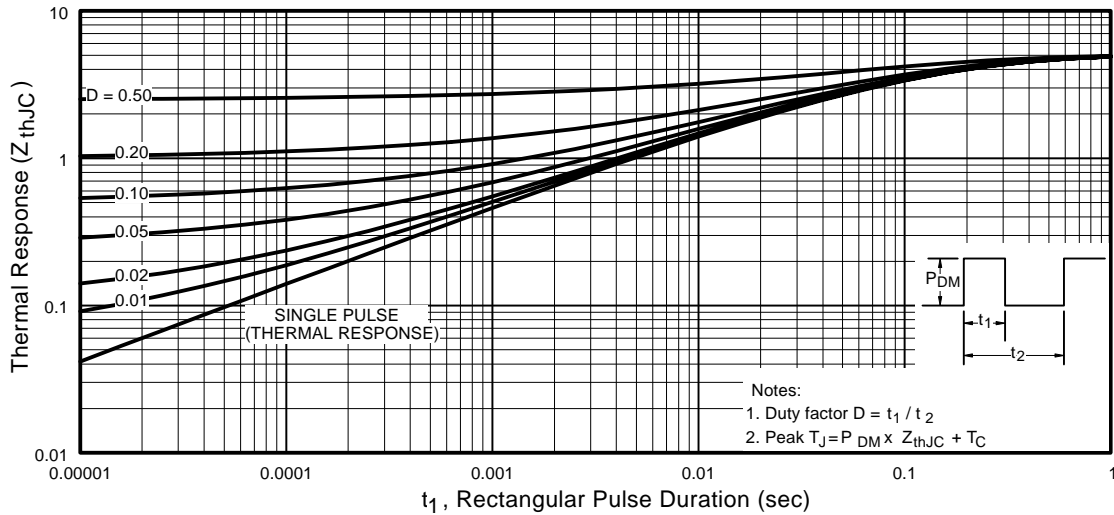

Fig 11. Maximum Effective Transient Thermal Impedance, Junction-to-Case

IRFE330, JANTX-, JANTXV-, 2N6800U Device

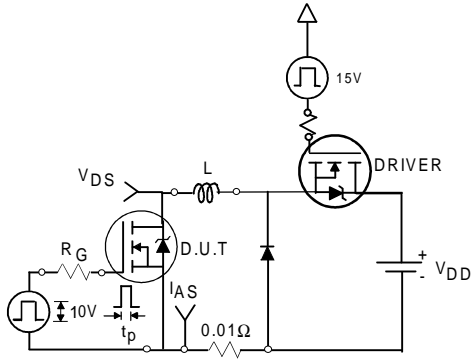

Fig 12a. Unclamped Inductive Test Circuit

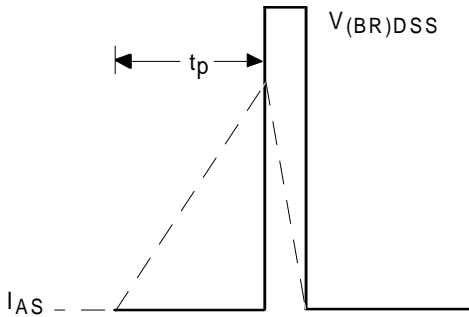

Fig 12b. Unclamped Inductive Waveforms

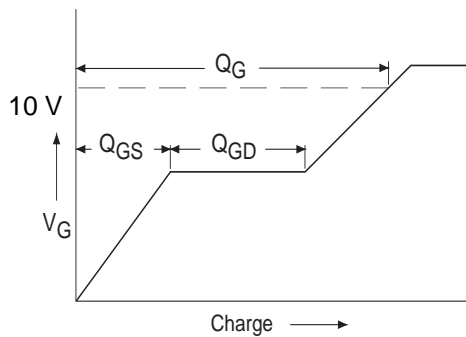

Fig 13a. Basic Gate Charge Waveform

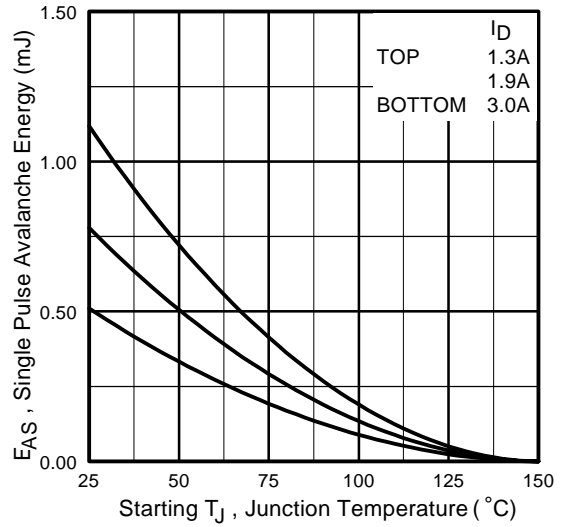

Fig 12c. Maximum Avalanche Energy Vs. Drain Current

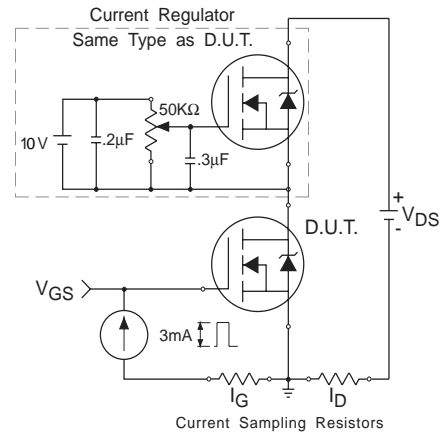
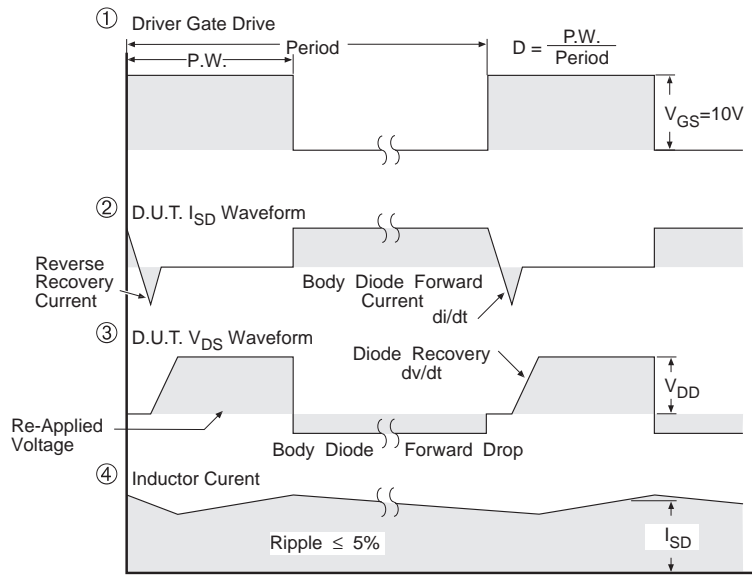
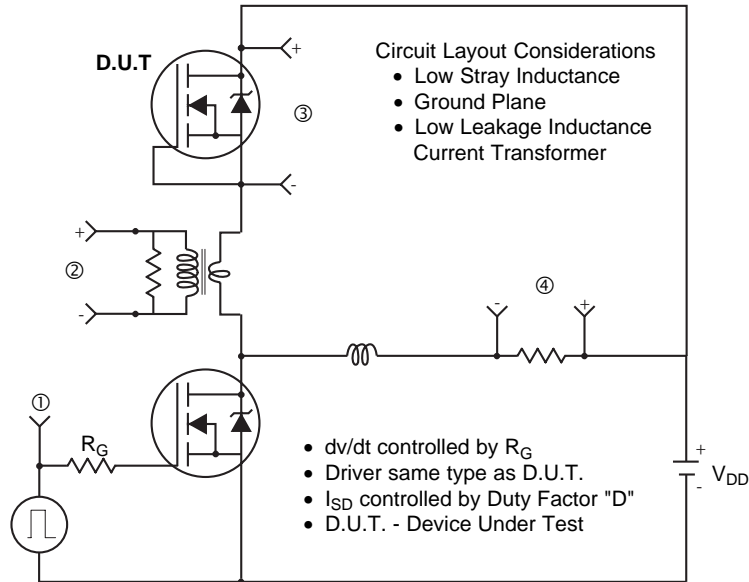

Fig 13b. Gate Charge Test Circuit

IRFE330, JANTX-, JANTXV-, 2N6800U Device

Peak Diode Recovery dv/dt Test Circuit



* $V_{GS} = 5V$ for Logic Level Devices

Fig 14. For N-Channel HEXFETS

IRFE330, JANTX-, JANTXV-, 2N6800U Device

Notes:

- ① Repetitive Rating; Pulse width limited by maximum junction temperature. Refer to current HEXFET reliability report.
 ② @ $V_{DD} = 50\text{ V}$, Starting $T_J = 25^\circ\text{C}$,
 $EAS = [0.5 \cdot L \cdot (I_L^2)]$
 Peak $I_L = 3.0\text{ A}$, $V_{GS} = 10\text{ V}$, $25 \leq R_G \leq 200\Omega$
 ③ $I_{SD} \leq 3.0\text{ A}$, $di/dt \leq 63\text{ A}/\mu\text{s}$,
 $V_{DD} \leq BV_{DSS}$, $T_J \leq 150^\circ\text{C}$
 Suggested $R_G = 2.35\Omega$
 ④ Pulse width $\leq 300\ \mu\text{s}$; Duty Cycle $\leq 2\%$ ⑤ $K/W = ^\circ\text{C}/\text{W}$

Case Outline and Dimensions — Leadless Chip Carrier (LCC) Package

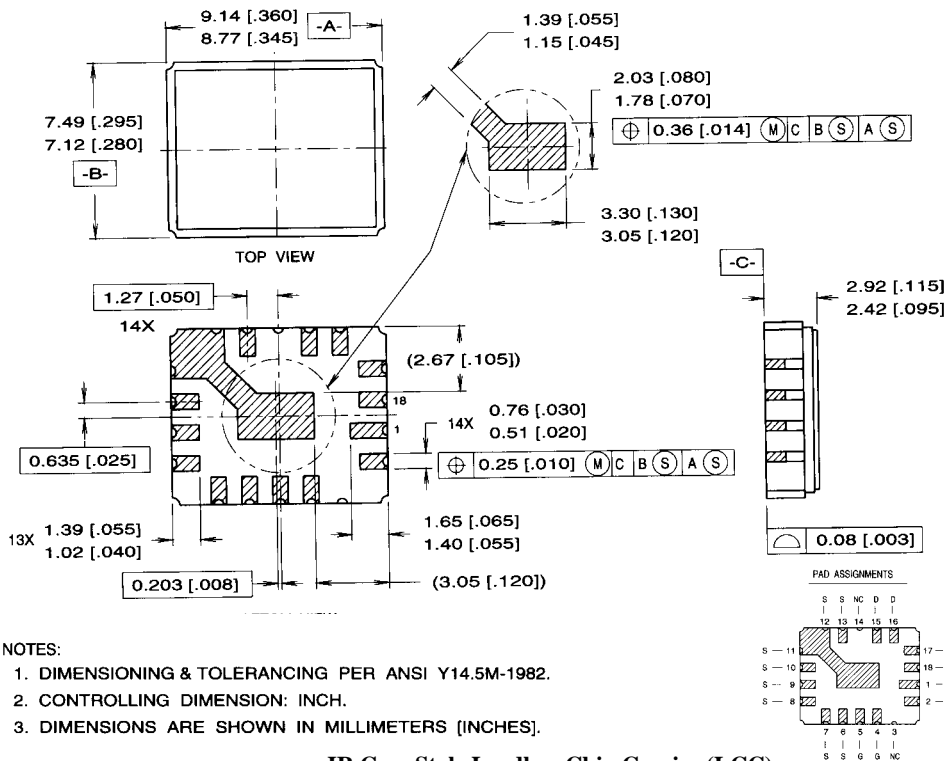

IR Case Style Leadless Chip Carrier (LCC)

International
IR Rectifier

WORLD HEADQUARTERS: 233 Kansas St., El Segundo, California 90245, Tel: (310) 322 3331

EUROPEAN HEADQUARTERS: Hurst Green, Oxted, Surrey RH8 9BB, UK Tel: ++ 44 1883 732020

IR CANADA: 7321 Victoria Park Ave., Suite 201, Markham, Ontario L3R 2Z8, Tel: (905) 475 1897

IR GERMANY: Saalburgstrasse 157, 61350 Bad Homburg Tel: ++ 49 6172 96590

IR ITALY: Via Liguria 49, 10071 Borgaro, Torino Tel: ++ 39 11 451 0111

IR FAR EAST: K&H Bldg., 2F, 30-4 Nishi-Ikebukuro 3-Chome, Toshima-Ku, Tokyo Japan 171 Tel: 81 3 3983 0086

IR SOUTHEAST ASIA: 315 Outram Road, #10-02 Tan Boon Liat Building, Singapore 0316 Tel: 65 221 8371

<http://www.irf.com/> Data and specifications subject to change without notice. 3/98