

## POWER MOSFET THRU-HOLE (MO-036AB)

## IRFG5110 100V, Combination 2N-2P-CHANNEL HEXFET<sup>®</sup> MOSFET TECHNOLOGY

### Product Summary

Part Number	R <sub>DS(on)</sub>	I <sub>D</sub>	CHANNEL
IRFG5110	0.7Ω	1.0A	N
IRFG5110	0.7Ω	-1.0A	P

HEXFET<sup>®</sup> MOSFET technology is the key to International Rectifier's advanced line of power MOSFET transistors. The efficient geometry design achieves very low on-state resistance combined with high transconductance. HEXFET transistors also feature all of the well-established advantages of MOSFETs, such as voltage control, very fast switching, ease of paralleling and electrical parameter temperature stability. They are well-suited for applications such as switching power supplies, motor controls, inverters, choppers, audio amplifiers, high energy pulse circuits, and virtually any application where high reliability is required. The HEXFET transistor's totally isolated package eliminates the need for additional isolating material between the device and the heatsink. This improves thermal efficiency and reduces drain capacitance.

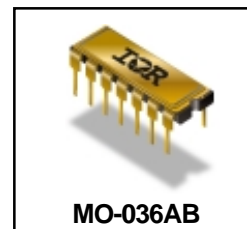

### Features:

- Simple Drive Requirements
- Ease of Paralleling
- Hermetically Sealed
- Electrically Isolated
- Dynamic dv/dt Rating
- Light-weight

### Absolute Maximum Ratings (Per Die)

	Parameter	N-Channel	P-Channel	Units
I <sub>D</sub> @ V <sub>GS</sub> = ±10V, T <sub>C</sub> = 25°C	Continuous Drain Current	1.0	-1.0	A
I <sub>D</sub> @ V <sub>GS</sub> = ±10V, T <sub>C</sub> = 100°C	Continuous Drain Current	0.6	-0.6	
I <sub>DM</sub>	Pulsed Drain Current <sup>①</sup>	4.0	-4.0	
P <sub>D</sub> @ T <sub>C</sub> = 25°C	Max. Power Dissipation	1.4	1.4	W
	Linear Derating Factor	0.011	0.011	W/°C
V <sub>GS</sub>	Gate-to-Source Voltage	±20	±20	V
E <sub>AS</sub>	Single Pulse Avalanche Energy	75 <sup>②</sup>	75 <sup>⑤</sup>	mJ
I <sub>AR</sub>	Avalanche Current <sup>①</sup>	—	—	A
E <sub>AR</sub>	Repetitive Avalanche Energy <sup>①</sup>	—	—	mJ
dv/dt	Peak Diode Recovery dv/dt	5.5 <sup>③</sup>	-5.5 <sup>⑥</sup>	V/ns
T <sub>J</sub>	Operating Junction	-55 to 150		°C
T <sub>STG</sub>	Storage Temperature Range			
	Lead Temperature	300 (0.63 in./1.6 mm from case for 10s)		
	Weight	1.3 (Typical)		g

For footnotes refer to the last page

**Electrical Characteristics For Each N-Channel Device @ T<sub>J</sub> = 25°C (Unless Otherwise Specified)**

	Parameter	Min	Typ	Max	Units	Test Conditions
BVDSS	Drain-to-Source Breakdown Voltage	100	—	—	V	V <sub>GS</sub> = 0V, I <sub>D</sub> = 1.0mA
ΔBVDSS/ΔT <sub>J</sub>	Temperature Coefficient of Breakdown Voltage	—	0.13	—	V/°C	Reference to 25°C, I <sub>D</sub> = 1.0mA
RDS(on)	Static Drain-to-Source On-State Resistance	—	—	0.7	Ω	V <sub>GS</sub> = 10V, I <sub>D</sub> = 0.6A ④
		—	—	0.8		
VGS(th)	Gate Threshold Voltage	2.0	—	4.0	V	V <sub>DS</sub> = V <sub>GS</sub> , I <sub>D</sub> = 250μA
gfs	Forward Transconductance	0.86	—	—	S (Ω)	V <sub>DS</sub> > 15V, I <sub>DS</sub> = 0.6A ④
IDSS	Zero Gate Voltage Drain Current	—	—	25	μA	V <sub>DS</sub> = 80V, V <sub>GS</sub> = 0V
		—	—	250		
IGSS	Gate-to-Source Leakage Forward	—	—	100	nA	V <sub>GS</sub> = 20V
IGSS	Gate-to-Source Leakage Reverse	—	—	-100	nA	V <sub>GS</sub> = -20V
Qg	Total Gate Charge	—	—	15	nC	V <sub>GS</sub> = 10V, I <sub>D</sub> = 1.0A, V <sub>DS</sub> = 50V
Qgs	Gate-to-Source Charge	—	—	7.5		
Qgd	Gate-to-Drain ('Miller') Charge	—	—	7.5		
td(on)	Turn-On Delay Time	—	—	20	ns	V <sub>DD</sub> = 50V, I <sub>D</sub> = 1.0A, V <sub>GS</sub> = 10V, R <sub>G</sub> = 24Ω
t <sub>r</sub>	Rise Time	—	—	25		
td(off)	Turn-Off Delay Time	—	—	40		
t <sub>f</sub>	Fall Time	—	—	40		
LS + LD	Total Inductance	—	10	—	nH	Measured from drain lead (6mm/ 0.25in. from package) to source lead (6mm/0.25in. from package)
Ciss	Input Capacitance	—	180	—	pF	V <sub>GS</sub> = 0V, V <sub>DS</sub> = 25V f = 1.0MHz
Coss	Output Capacitance	—	82	—		
Crss	Reverse Transfer Capacitance	—	15	—		

**Source-Drain Diode Ratings and Characteristics (Per Die)**

	Parameter	Min	Typ	Max	Units	Test Conditions
I <sub>S</sub>	Continuous Source Current (Body Diode)	—	—	1.0	A	T <sub>J</sub> = 25°C, I <sub>S</sub> = 1.0A, V <sub>GS</sub> = 0V ④
I <sub>SM</sub>	Pulse Source Current (Body Diode) ①	—	—	4.0		
V <sub>SD</sub>	Diode Forward Voltage	—	—	1.5	V	T <sub>J</sub> = 25°C, I <sub>F</sub> = 1.0A, di/dt ≤ 100A/μs
t <sub>rr</sub>	Reverse Recovery Time	—	—	200	nS	V <sub>DD</sub> ≤ 50V ④
Q <sub>RR</sub>	Reverse Recovery Charge	—	—	0.83	nC	
t <sub>on</sub>	Forward Turn-On Time	Intrinsic turn-on time is negligible. Turn-on speed is substantially controlled by L <sub>S</sub> + L <sub>D</sub> .				

**Thermal Resistance (Per Die)**

	Parameter	Min	Typ	Max	Units	Test Conditions
R <sub>thJC</sub>	Junction-to-Case	—	—	17	°C/W	Typical socket mount
R <sub>thJA</sub>	Junction-to-Ambient	—	—	90		

Note: Corresponding Spice and Saber models are available on the G&S Website.

For footnotes refer to the last page

**Electrical Characteristics For Each P-Channel Device @ T<sub>J</sub> = 25°C (Unless Otherwise Specified)**

	Parameter	Min	Typ	Max	Units	Test Conditions
BV <sub>DSS</sub>	Drain-to-Source Breakdown Voltage	-100	—	—	V	V <sub>GS</sub> = 0V, I <sub>D</sub> = -1.0mA
ΔBV <sub>DSS</sub> /ΔT <sub>J</sub>	Temperature Coefficient of Breakdown Voltage	—	-0.22	—	V/°C	Reference to 25°C, I <sub>D</sub> = -1.0mA
R <sub>DS(on)</sub>	Static Drain-to-Source On-State Resistance	—	—	0.7	Ω	V <sub>GS</sub> = -10V, I <sub>D</sub> = -0.6A ④
		—	—	0.8		
V <sub>GS(th)</sub>	Gate Threshold Voltage	-2.0	—	-4.0	V	V <sub>DS</sub> = V <sub>GS</sub> , I <sub>D</sub> = -250μA
g <sub>fs</sub>	Forward Transconductance	1.1	—	—	S (Ω)	V <sub>DS</sub> > -15V, I <sub>DS</sub> = -0.6A ④
I <sub>DSS</sub>	Zero Gate Voltage Drain Current	—	—	-25	μA	V <sub>DS</sub> = -80V, V <sub>GS</sub> = 0V
		—	—	-250		V <sub>DS</sub> = -80V, V <sub>GS</sub> = 0V, T <sub>J</sub> = 125°C
I <sub>GSS</sub>	Gate-to-Source Leakage Forward	—	—	-100	nA	V <sub>GS</sub> = -20V
I <sub>GSS</sub>	Gate-to-Source Leakage Reverse	—	—	100		V <sub>GS</sub> = 20V
Q <sub>g</sub>	Total Gate Charge	—	—	22	nC	V <sub>GS</sub> = -10V, I <sub>D</sub> = -1.0A, V <sub>DS</sub> = -50V
Q <sub>gs</sub>	Gate-to-Source Charge	—	—	8.0		
Q <sub>gd</sub>	Gate-to-Drain ('Miller') Charge	—	—	14		
t <sub>d(on)</sub>	Turn-On Delay Time	—	—	30	ns	V <sub>DD</sub> = -50V, I <sub>D</sub> = -1.0A, V <sub>GS</sub> = -10V, R <sub>G</sub> = 24Ω
t <sub>r</sub>	Rise Time	—	—	60		
t <sub>d(off)</sub>	Turn-Off Delay Time	—	—	60		
t <sub>f</sub>	Fall Time	—	—	60		
L <sub>S</sub> + L <sub>D</sub>	Total Inductance	—	10	—	nH	Measured from drain lead (6mm/ 0.25in. from package) to source lead (6mm/0.25in. from package)
C <sub>iss</sub>	Input Capacitance	—	390	—	pF	V <sub>GS</sub> = 0V, V <sub>DS</sub> = -25V f = 1.0MHz
C <sub>oss</sub>	Output Capacitance	—	170	—		
C <sub>rss</sub>	Reverse Transfer Capacitance	—	45	—		

**Source-Drain Diode Ratings and Characteristics (Per Die)**

	Parameter	Min	Typ	Max	Units	Test Conditions
I <sub>S</sub>	Continuous Source Current (Body Diode)	—	—	-1.0	A	T <sub>J</sub> = 25°C, I <sub>S</sub> = -1.0A, V <sub>GS</sub> = 0V ④
I <sub>SM</sub>	Pulse Source Current (Body Diode) ①	—	—	-4.0		
V <sub>SD</sub>	Diode Forward Voltage	—	—	-5.5	V	T <sub>J</sub> = 25°C, I <sub>F</sub> = -1.0A, di/dt ≤ -100A/μs
t <sub>rr</sub>	Reverse Recovery Time	—	—	200	nS	V <sub>DD</sub> ≤ -50V
Q <sub>RR</sub>	Reverse Recovery Charge	—	—	0.66	nC	
t <sub>on</sub>	Forward Turn-On Time	Intrinsic turn-on time is negligible. Turn-on speed is substantially controlled by L <sub>S</sub> + L <sub>D</sub> .				

**Thermal Resistance (Per Die)**

	Parameter	Min	Typ	Max	Units	Test Conditions
R <sub>thJC</sub>	Junction-to-Case	—	—	17	°C/W	Typical socket mount
R <sub>thJA</sub>	Junction-to-Ambient	—	—	90		

For footnotes refer to the last page

N-Channel  
Q1,Q3

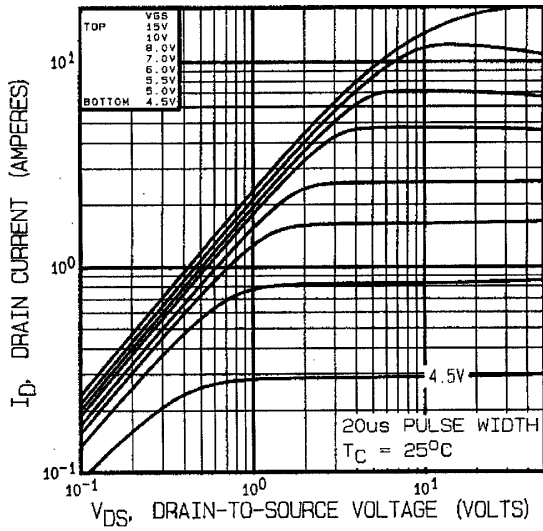

Fig 1. Typical Output Characteristics

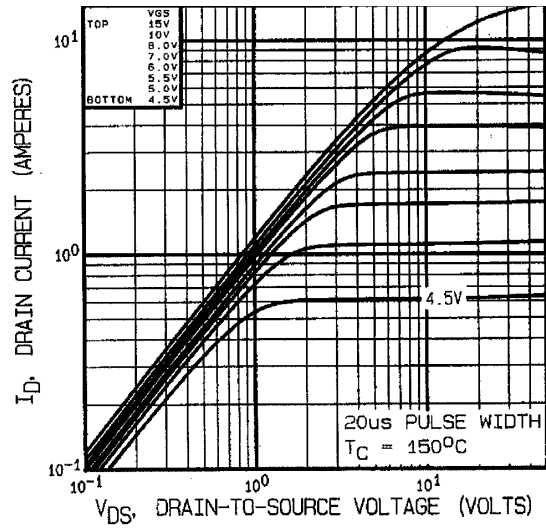

Fig 2. Typical Output Characteristics

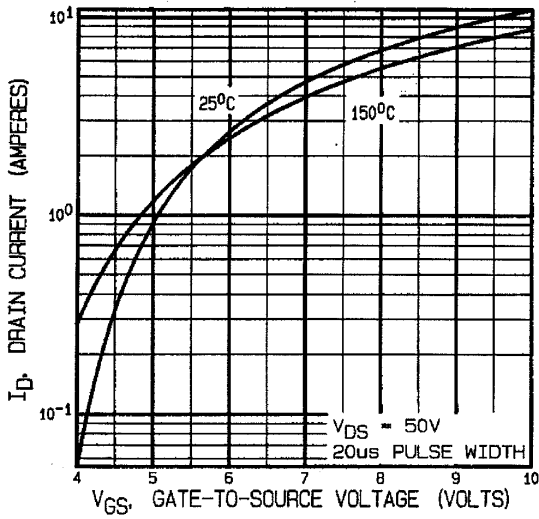

Fig 3. Typical Transfer Characteristics

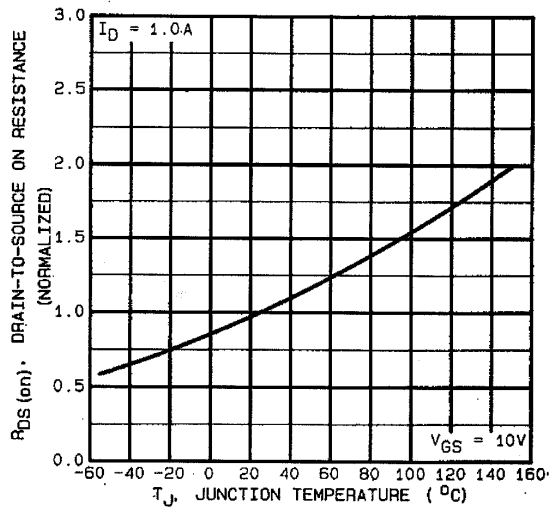

Fig 4. Normalized On-Resistance  
Vs. Temperature

N-Channel  
Q1,Q3

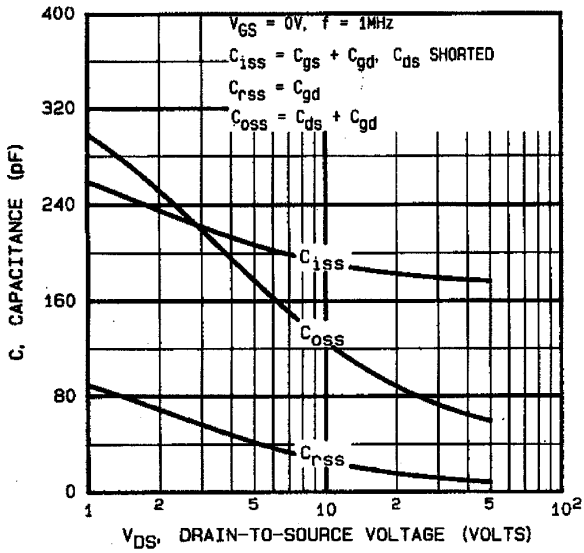

Fig 5. Typical Capacitance Vs. Drain-to-Source Voltage

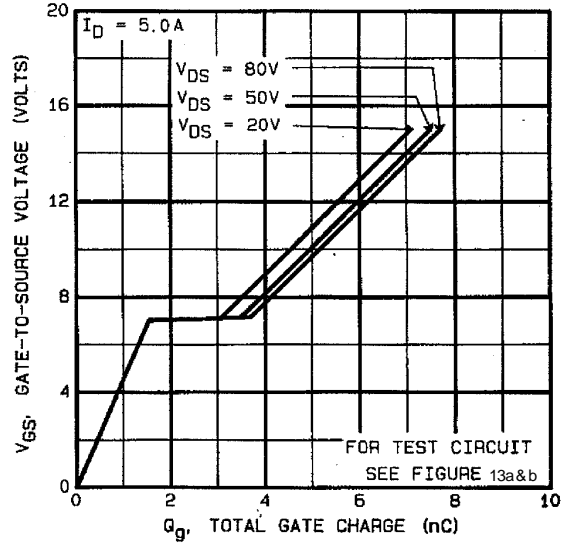

Fig 6. Typical Gate Charge Vs. Gate-to-Source Voltage

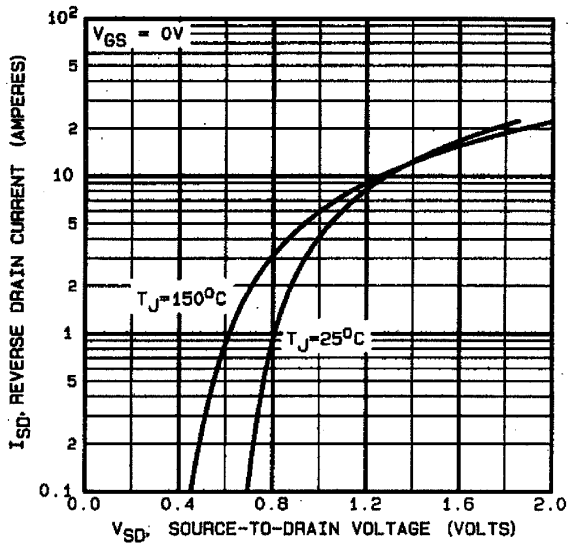

Fig 7. Typical Source-Drain Diode Forward Voltage

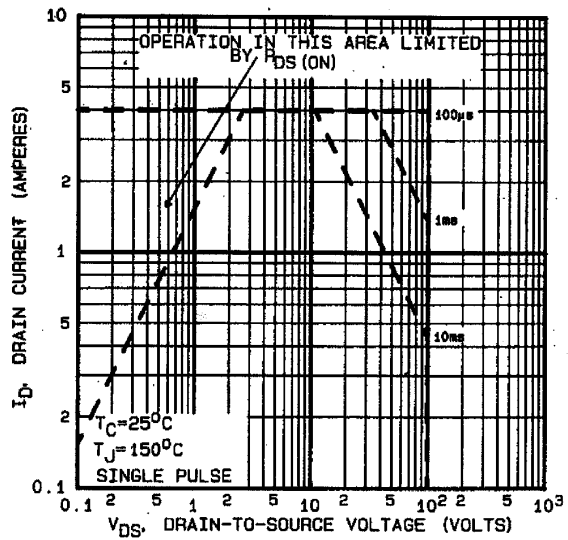

Fig 8. Maximum Safe Operating Area

N-Channel  
Q1,Q3

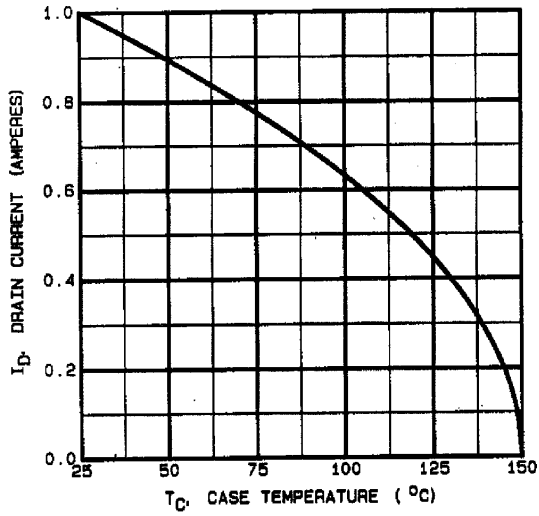

Fig 9. Maximum Drain Current Vs. Case Temperature

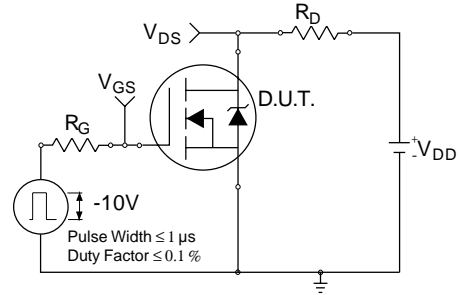

Fig 10a. Switching Time Test Circuit

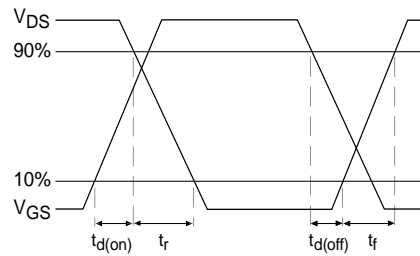

Fig 10b. Switching Time Waveforms

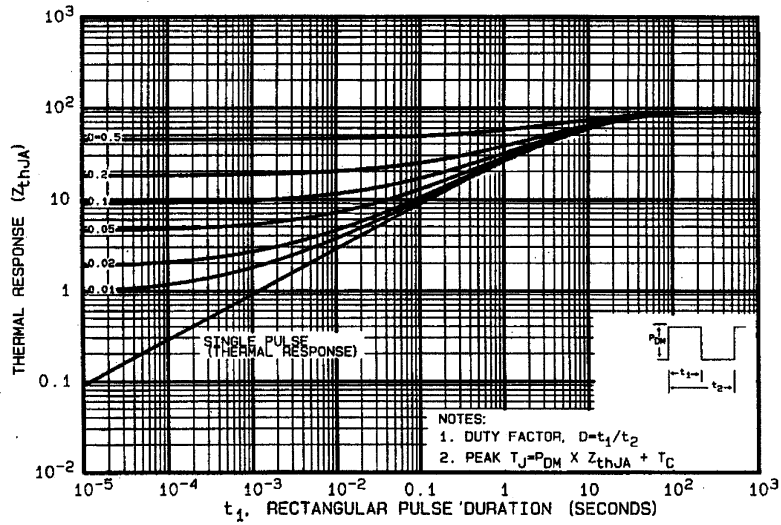

Fig 11. Maximum Effective Transient Thermal Impedance, Junction-to-Ambient

N-Channel  
Q1,Q3

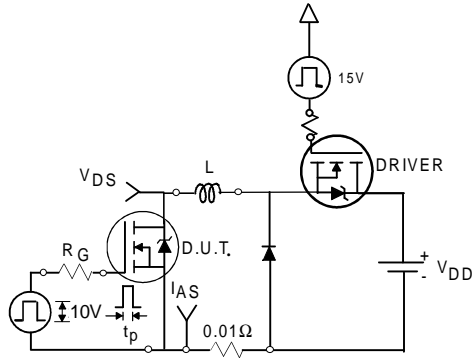

Fig 12a. Unclamped Inductive Test Circuit

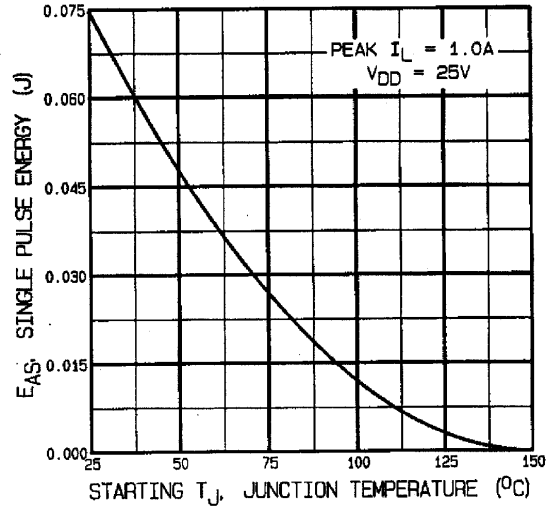

Fig 12c. Maximum Avalanche Energy Vs. Drain Current

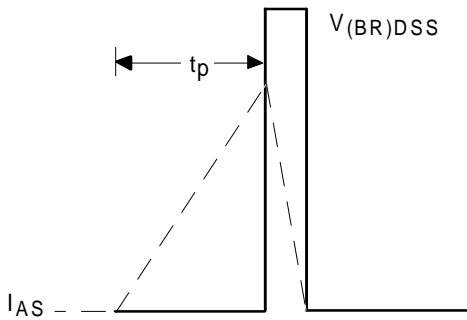

Fig 12b. Unclamped Inductive Waveforms

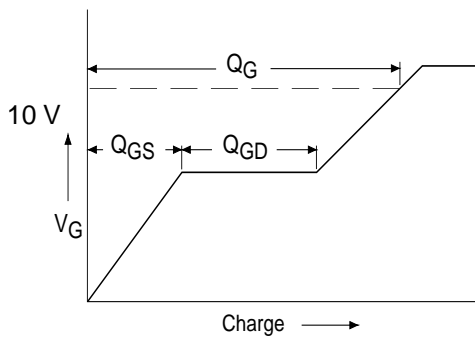

Fig 13a. Basic Gate Charge Waveform

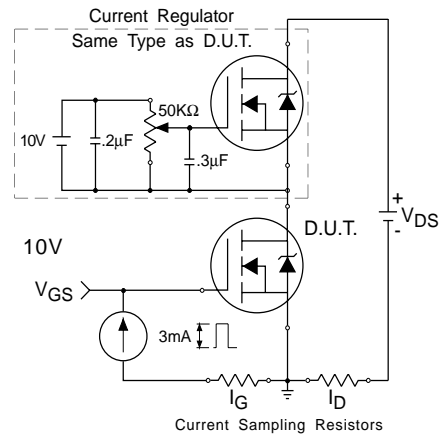

Fig 13b. Gate Charge Test Circuit

P-Channel  
Q2,Q4

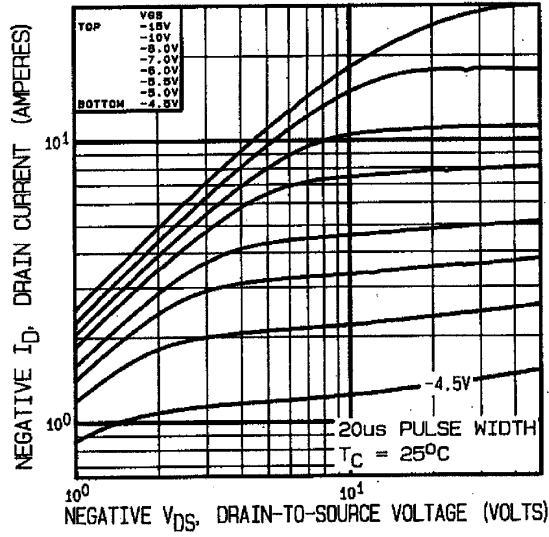

Fig 14. Typical Output Characteristics

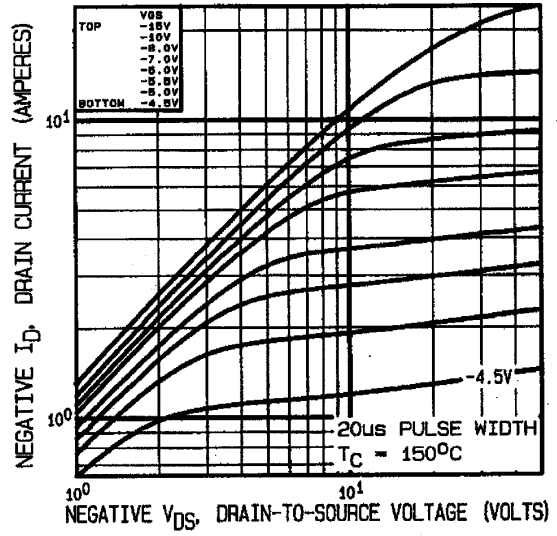

Fig 15. Typical Output Characteristics

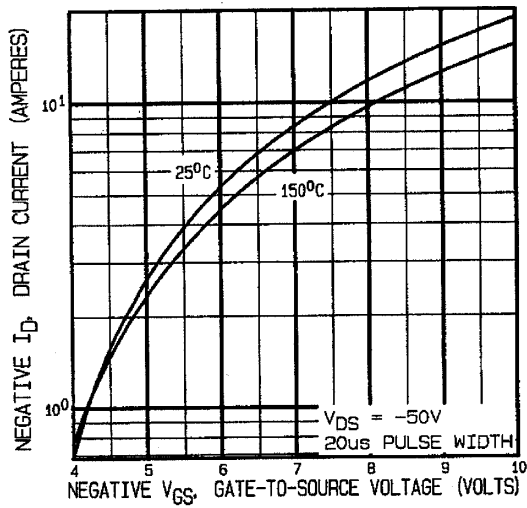

Fig 16. Typical Transfer Characteristics

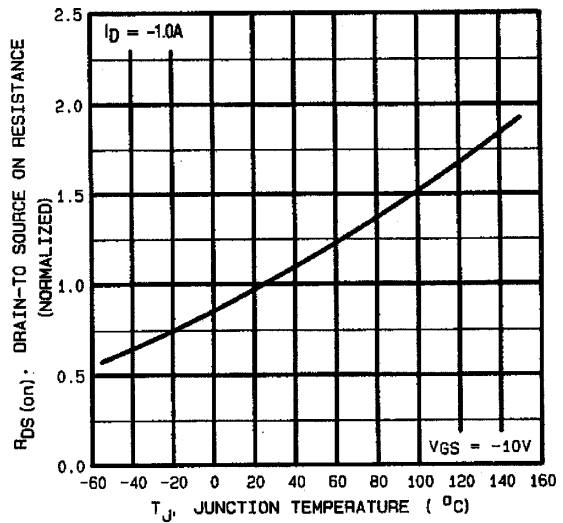

Fig 17. Normalized On-Resistance  
Vs. Temperature



P-Channel  
Q2,Q4

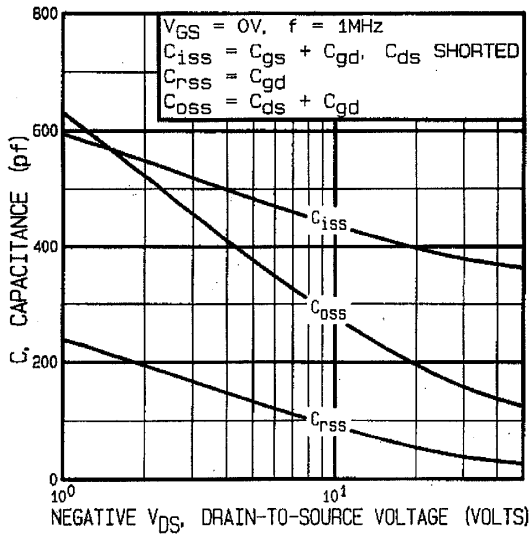

Fig 18. Typical Capacitance Vs. Drain-to-Source Voltage

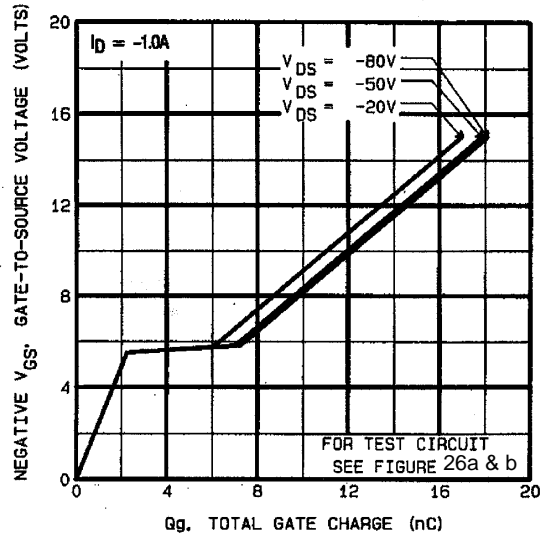

Fig 19. Typical Gate Charge Vs. Gate-to-Source Voltage

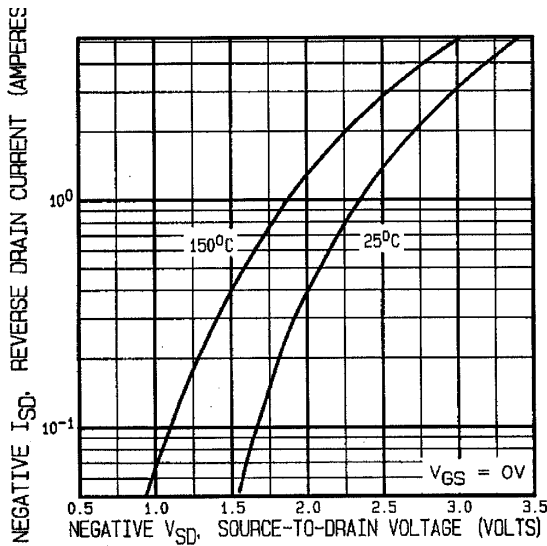

Fig20. Typical Source-Drain Diode Forward Voltage

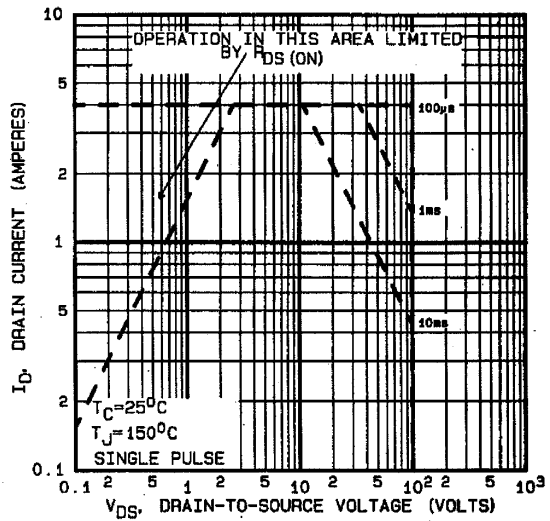

Fig 21. Maximum Safe Operating Area

P-Channel  
Q2,Q4

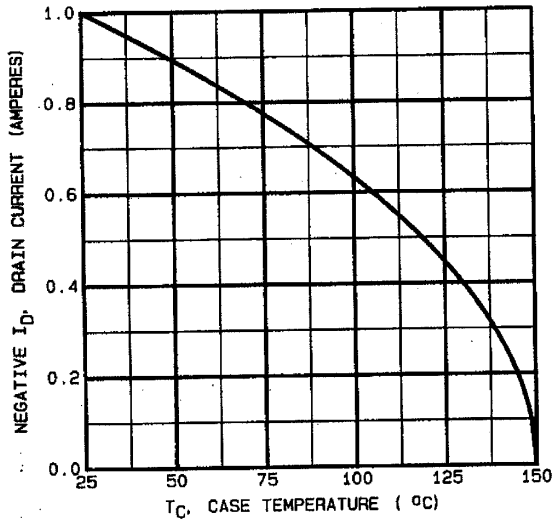

Fig 22. Maximum Drain Current Vs. Case Temperature

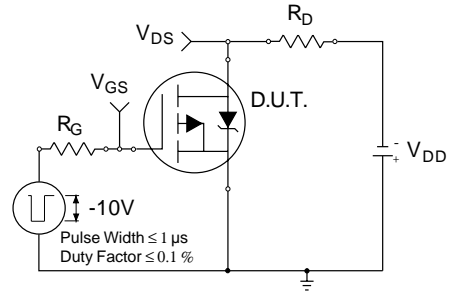

Fig 23a. Switching Time Test Circuit

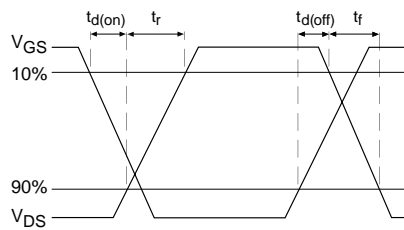

Fig 23b. Switching Time Waveforms

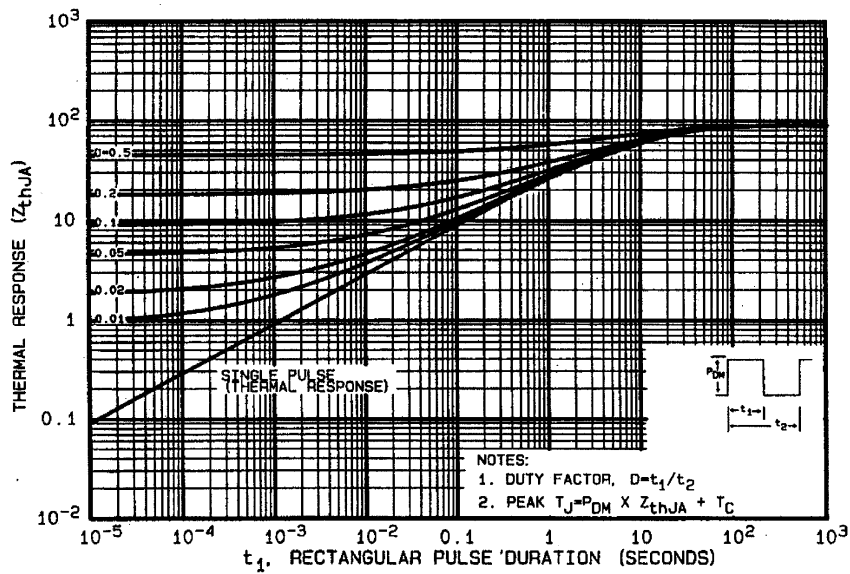
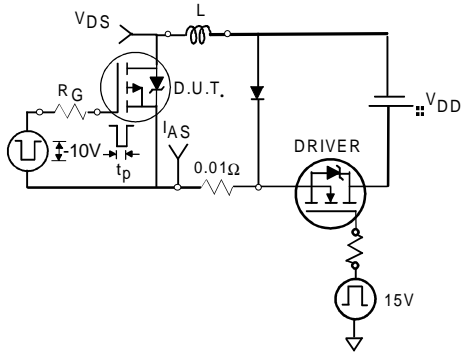
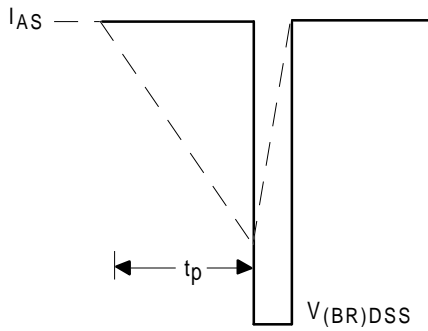

Fig 24. Maximum Effective Transient Thermal Impedance, Junction-to-Ambient

**P-Channel  
Q2,Q4**



**Fig 25a.** Unclamped Inductive Test Circuit



**Fig 25b.** Unclamped Inductive Waveforms

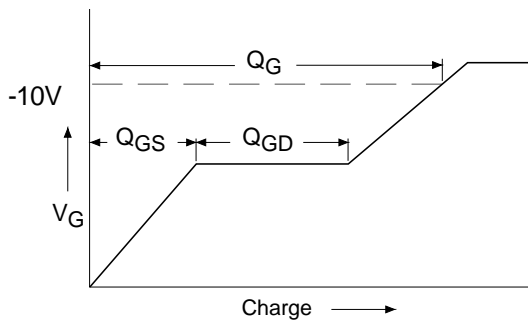

**Fig 26a.** Basic Gate Charge Waveform

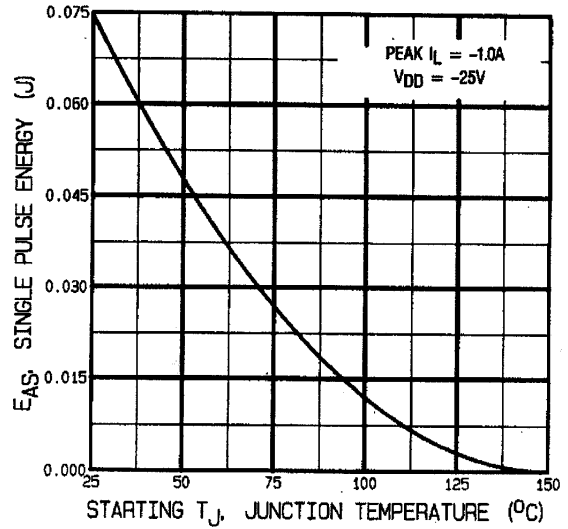

**Fig 25c.** Maximum Avalanche Energy Vs. Drain Current

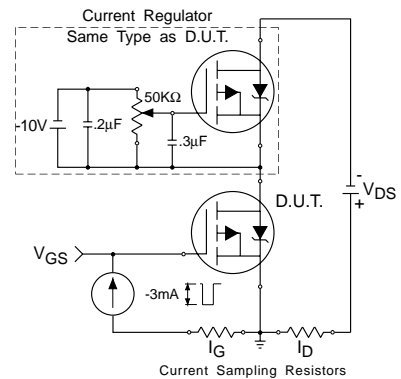

**Fig 26b.** Gate Charge Test Circuit

# IRFG5110



## Footnotes:

- ① Repetitive Rating; Pulse width limited by maximum junction temperature.
- ②  $V_{DD} = 50V$ , starting  $T_J = 25^\circ C$ ,  $L = 150mH$ , Peak  $I_L = 1.0A$ ,  $V_{GS} = 10V$
- ③  $I_{SD} \leq 1.0A$ ,  $di/dt \leq 75A/\mu s$ ,  $V_{DD} \leq 100V$ ,  $T_J \leq 150^\circ C$
- ④ Pulse width  $\leq 300 \mu s$ ; Duty Cycle  $\leq 2\%$
- ⑤  $V_{DD} = -25V$ , starting  $T_J = 25^\circ C$ ,  $L = 150mH$ , Peak  $I_L = -1.0A$ ,  $V_{GS} = -10V$
- ⑥  $I_{SD} \leq -1.0A$ ,  $di/dt \leq -110A/\mu s$ ,  $V_{DD} \leq -100V$ ,  $T_J \leq 150^\circ C$

## Case Outline and Dimensions — MO-036AB

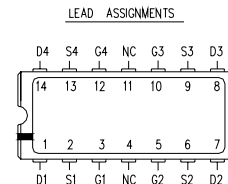
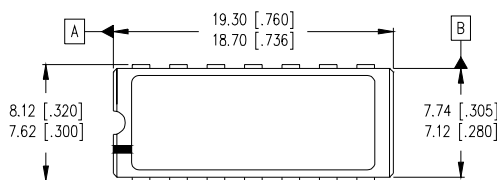

LEGEND  
 G = GATE      S = SOURCE  
 D = DRAIN    NC = NO CONNECTION

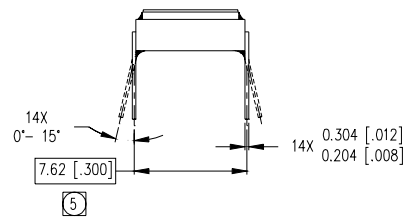
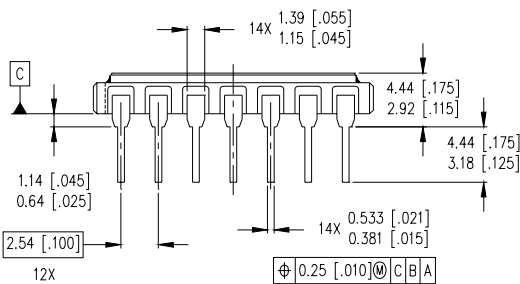

- NOTES:
1. DIMENSIONING & TOLERANCING PER ASME Y14.5M-1994.
  2. CONTROLLING DIMENSION: INCH.
  3. DIMENSIONS ARE SHOWN IN MILLIMETERS [INCHES].
  4. OUTLINE CONFORMS TO JEDEC OUTLINE MO-036AB.
  - ⑤ MEASURED WITH THE LEADS CONSTRAINED TO BE PERPENDICULAR TO DATUM PLANE C.



IR WORLD HEADQUARTERS: 233 Kansas St., El Segundo, California 90245, USA Tel: (310) 252-7105  
 TAC Fax: (310) 252-7903

Visit us at [www.irf.com](http://www.irf.com) for sales contact information.  
 Data and specifications subject to change without notice.04/02