

HEXFET® POWER MOSFET

IRFN054 N-CHANNEL

60 Volt, 0.020Ω HEXFET

HEXFET technology is the key to International Rectifier's advanced line of power MOSFET transistors. The efficient geometry achieves very low on-state resistance combined with high transconductance.

HEXFET transistors also feature all of the well-established advantages of MOSFETs, such as voltage control, very fast switching, ease of paralleling and electrical parameter temperature stability. They are well-suited for applications such as switching power supplies, motor controls, inverters, choppers, audio amplifiers, and high energy pulse circuits.

The Surface Mount Device (SMD-1) package represents another step in the continual evolution of surface mount technology. The SMD-1 will give designers the extra flexibility they need to increase circuit board density. International Rectifier has engineered the SMD-1 package to meet the specific needs of the power market by increasing the size of the termination pads, thereby enhancing thermal and electrical performance.

Product Summary

Part Number	BV _{DSS}	R _{DS(on)}	I _D
IRFN054	60V	0.020Ω	55A*

Features:

- Avalanche Energy Rating
- Dynamic dv/dt Rating
- Simple Drive Requirements
- Ease of Paralleling
- Hermetically Sealed
- Surface Mount
- Light-weight

Absolute Maximum Ratings

	Parameter	IRFN054	Units
I _D @ V _{GS} = 10V, T _C = 25°C	Continuous Drain Current	55*	A
I _D @ V _{GS} = 10V, T _C = 100°C	Continuous Drain Current	40	
I _{DM}	Pulsed Drain Current ①	256	
P _D @ T _C = 25°C	Max. Power Dissipation	150	W
	Linear Derating Factor	1.2	W/K ⑤
V _{GS}	Gate-to-Source Voltage	±20	V
E _{AS}	Single Pulse Avalanche Energy ②	480	mJ
I _{AR}	Avalanche Current ①	55	A
E _{AR}	Repetitive Avalanche Energy ①	15	mJ
dv/dt	Peak Diode Recovery dv/dt ③	4.5	V/ns
T _J	Operating Junction	-55 to 150	°C
T _{STG}	Storage Temperature Range		
	Package Mounting Surface Temperature		
	Weight	2.6 (typical)	g

Electrical Characteristics @ Tj = 25°C (Unless Otherwise Specified)

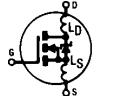
	Parameter	Min.	Typ.	Max.	Units	Test Conditions
BV_{DSS}	Drain-to-Source Breakdown Voltage	60	—	—	V	$V_{GS} = 0V, I_D = 1.0 \text{ mA}$
$\Delta BV_{DSS}/\Delta T_J$	Temperature Coefficient of Breakdown Voltage	—	0.68	—	V/°C	Reference to 25°C, $I_D = 1.0 \text{ mA}$
RDS(on)	Static Drain-to-Source On-State Resistance	—	—	0.020	Ω	$V_{GS} = 10V, I_D = 40A$ ④
		—	—	0.031		$V_{GS} = 10V, I_D = 55A$
$V_{GS(th)}$	Gate Threshold Voltage	2.0	—	4.0	V	$V_{DS} = V_{GS}, I_D = 250\mu A$
g_{fs}	Forward Transconductance	20	—	—	S (r)	$V_{DS} > 15V, I_{DS} = 40A$ ④
IDSS	Zero Gate Voltage Drain Current	—	—	25	μA	$V_{DS} = 0.8 \times \text{Max Rating}, V_{GS} = 0V$
		—	—	250		$V_{DS} = 0.8 \times \text{Max Rating}, V_{GS} = 0V, T_J = 125^\circ C$
IGSS	Gate-to-Source Leakage Forward	—	—	100	nA	$V_{GS} = 20V$
IGSS	Gate-to-Source Leakage Reverse	—	—	-100	nA	$V_{GS} = -20V$
Q_g	Total Gate Charge	39	—	88	nC	$V_{GS} = 10V, I_D = 55A$
Q_{gs}	Gate-to-Source Charge	20	—	45		$V_{DS} = \text{Max. Rating} \times 0.5$
Q_{gd}	Gate-to-Drain ("Miller") Charge	34	—	105		see figures 6 and 13
$t_{d(on)}$	Turn-On Delay Time	—	—	33	ns	$V_{DD} = 30V, I_D = 55A, R_G = 2.35\Omega, V_{GS} = 10V$
t_r	Rise Time	—	—	180		
$t_{d(off)}$	Turn-Off Delay Time	—	—	100		
t_f	Fall Time	—	—	100		
LD	Internal Drain Inductance	—	2.0	—	nH	<p>Measured from the drain lead, 6mm (0.25 in.) from package to center of die.</p> <p>Measured from the source lead, 6mm (0.25 in.) from package to source bonding pad.</p> 
LS	Internal Source Inductance	—	4.1	—		
C_{iss}	Input Capacitance	—	1660	—	pF	$V_{GS} = 0V, V_{DS} = 25V$ $f = 1.0 \text{ MHz}$ see figure 5
C_{oss}	Output Capacitance	—	2000	—		
C_{rss}	Reverse Transfer Capacitance	—	340	—		

Source-Drain Diode Ratings and Characteristics

	Parameter	Min.	Typ.	Max.	Units	Test Conditions
I_S	Continuous Source Current (Body Diode)	—	—	55	A	Modified MOSFET symbol showing the integral reverse p-n junction rectifier. 
I_{SM}	Pulse Source Current (Body Diode) ①	—	—	256		
V_{SD}	Diode Forward Voltage	—	—	2.5	V	$T_J = 25^\circ C, I_S = 55A, V_{GS} = 0V$ ④
t_{rr}	Reverse Recovery Time	—	—	280	ns	$T_J = 25^\circ C, I_F = 55A, di/dt \leq 100A/\mu s$ $V_{DD} \leq 50V$ ④
Q_{RR}	Reverse Recovery Charge	—	—	2.2	μC	
t_{on}	Forward Turn-On Time	Intrinsic turn-on time is negligible. Turn-on speed is substantially controlled by $L_S + L_D$.				

Thermal Resistance

	Parameter	Min.	Typ.	Max.	Units	Test Conditions
R_{thJC}	Junction-to-Case	—	—	0.83	K/W	Soldered to a copper clad PC board
$R_{thJ-PCB}$	Junction-to-PC Board	—	TBD	—		

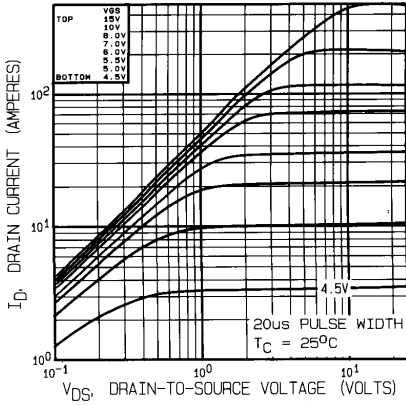

Fig. 1 — Typical Output Characteristics
 $T_C = 25^\circ\text{C}$

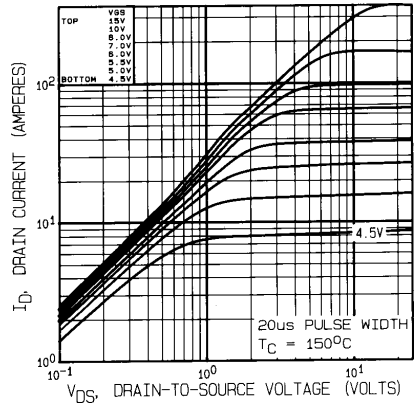

Fig. 2 — Typical Output Characteristics
 $T_C = 150^\circ\text{C}$

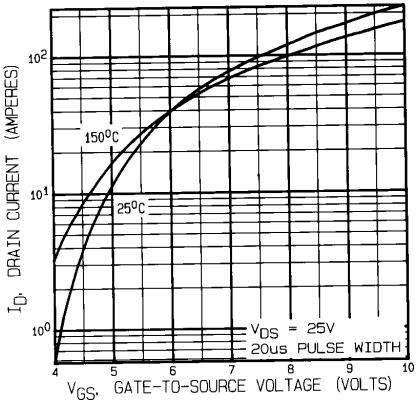

Fig. 3 — Typical Transfer Characteristics

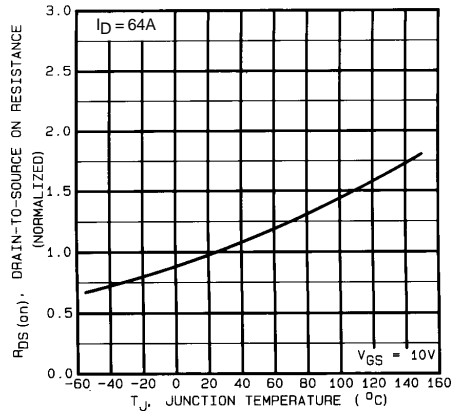

Fig. 4 — Normalized On-Resistance Vs. Temperature

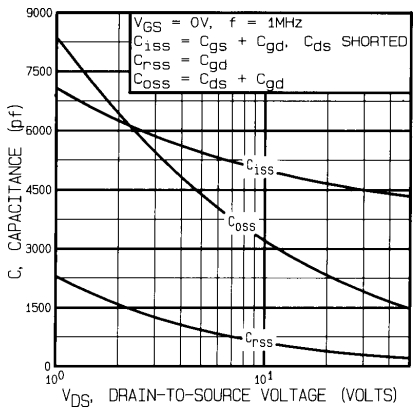

Fig. 5 — Typical Capacitance Vs. Drain-to-Source Voltage

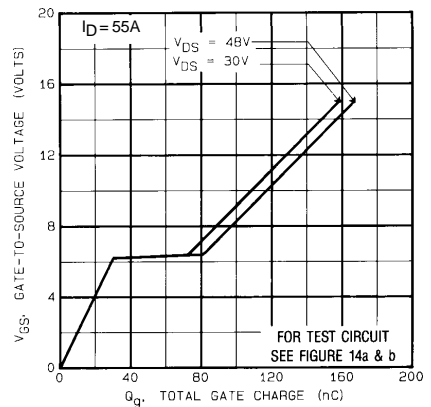

Fig. 6 — Typical Gate Charge Vs. Gate-to-Source Voltage

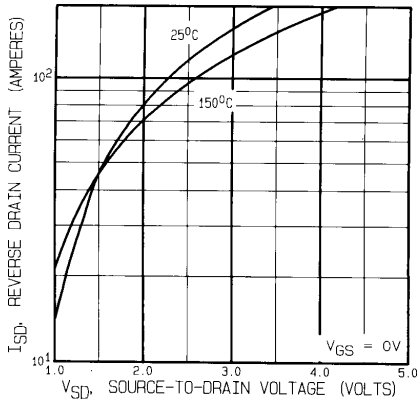

Fig. 7 — Typical Source-to-Drain Diode Forward Voltage

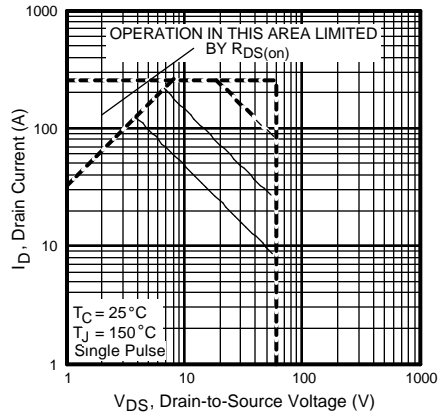

Fig. 8 — Maximum Safe Operating Area

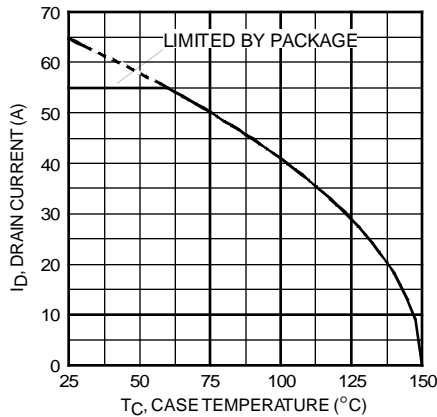

Fig. 9 — Maximum Drain Current Vs. Case Temperature

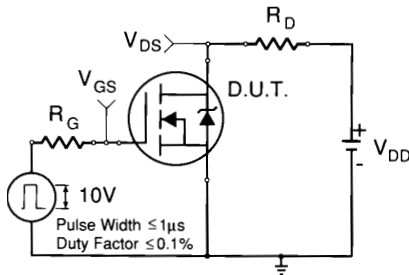

Fig. 10a — Switching Time Test Circuit

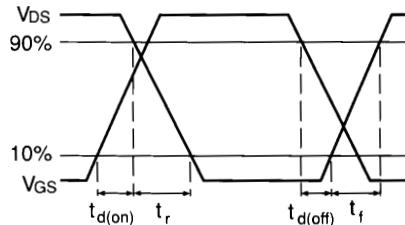

Fig. 10b — Switching Time Waveforms

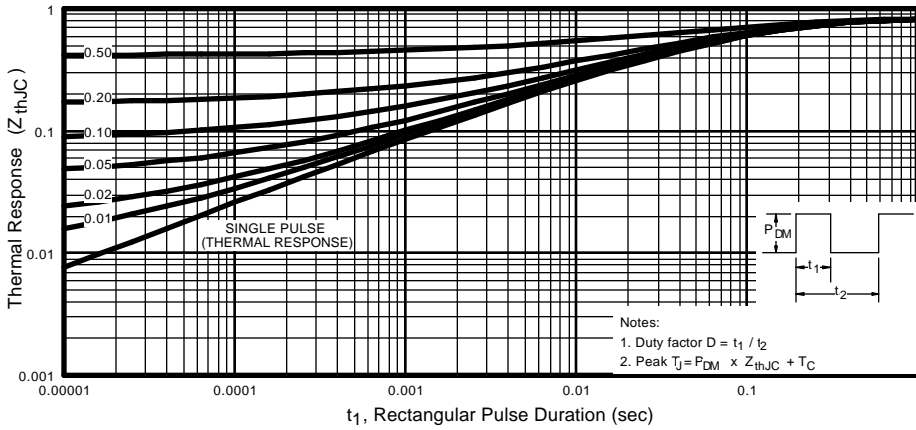

Fig. 11 — Maximum Effective Transient Thermal Impedance, Junction-to-Case Vs. Pulse Duration

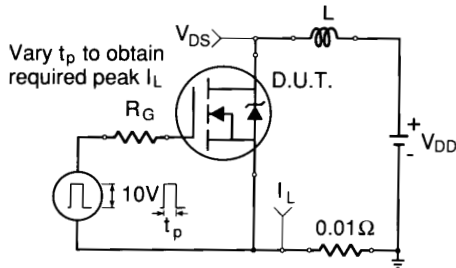

Fig. 12a — Unclamped Inductive Test Circuit

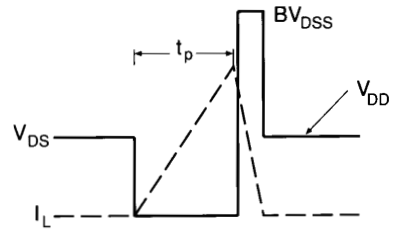

Fig. 12b — Unclamped Inductive Waveforms

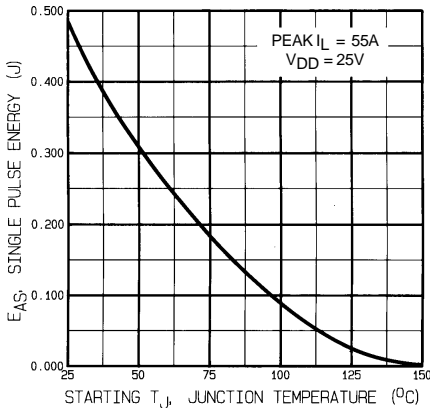

Fig. 12c — Max. Avalanche Energy vs. Current

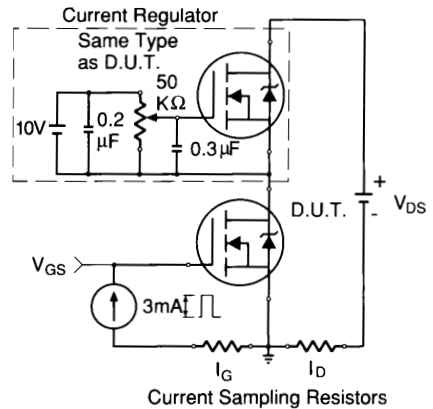

Fig. 13a — Gate Charge Test Circuit

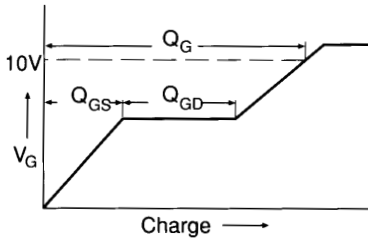
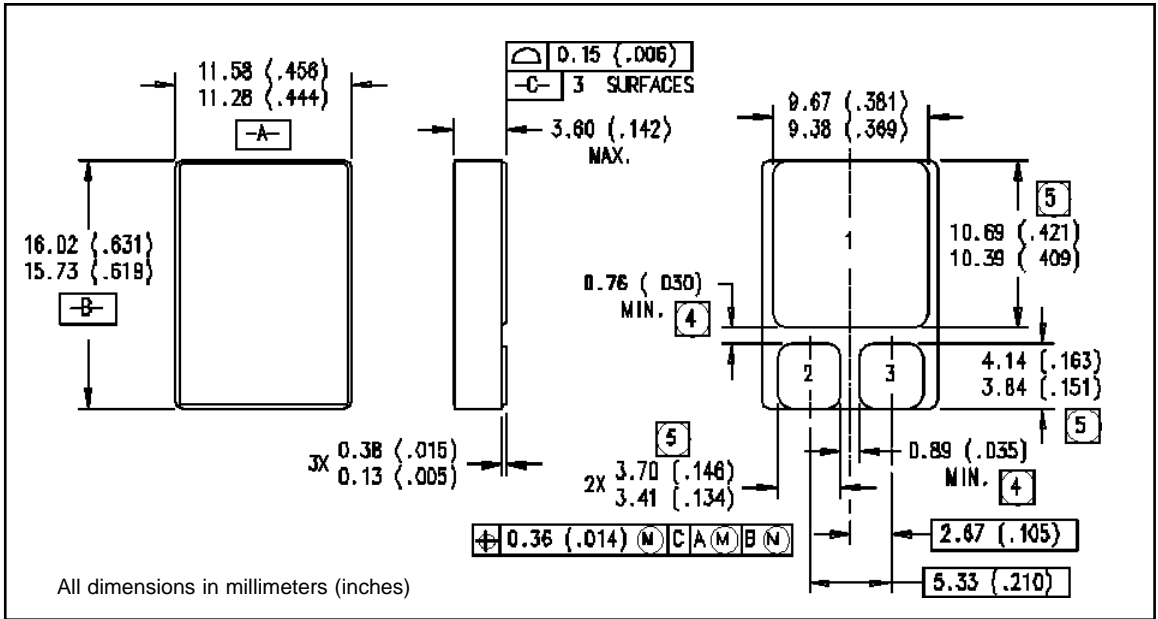

Fig. 13b — Basic Gate Charge Waveform

- ① Repetitive Rating; Pulse width limited by maximum junction temperature. (see figure 11)
- ② @ $V_{DD} = 25V$, Starting $T_J = 25^\circ C$,
 $EAS = [0.5 * L * (I_L^2) * [BV_{DSS}/(BV_{DSS}-V_{DD})]$
 Peak $I_L = 55A$, $V_{GS} = 10V$, $25 \leq R_G \leq 200\Omega$
- ③ $I_{SD} \leq 55A$, $di/dt \leq 200A/\mu s$,
 $V_{DD} \leq BV_{DSS}$, $T_J \leq 150^\circ C$
- ④ Pulse width $\leq 300 \mu s$; Duty Cycle $\leq 2\%$
- ⑤ $K/W = ^\circ C/W$
 $W/K = W/^\circ C$

Case Outline and Dimensions — SMD-1



International
IR Rectifier

WORLD HEADQUARTERS: 233 Kansas St., El Segundo, California 90245, Tel: (310) 322 3331
EUROPEAN HEADQUARTERS: Hurst Green, Oxted, Surrey RH8 9BB, UK Tel: ++ 44 1883 732020
IR CANADA: 7321 Victoria Park Ave., Suite 201, Markham, Ontario L3R 2Z8, Tel: (905) 475 1897
IR GERMANY: Saalburgstrasse 157, 61350 Bad Homburg Tel: ++ 49 6172 96590
IR ITALY: Via Liguria 49, 10071 Borgaro, Torino Tel: ++ 39 11 451 0111
IR FAR EAST: K&H Bldg., 2F, 3-30-4 Nishi-Ikeburo 3-Chome, Toshima-Ki, Tokyo Japan 171 Tel: 81 3 3983 0086
IR SOUTHEAST ASIA: 315 Outram Road, #10-02 Tan Boon Liat Building, Singapore 0316 Tel: 65 221 8371