

International
IR Rectifier
 HEXFET[®] Power MOSFET

PD-95669

IRFP044PbF

- Dynamic dv/dt Rating
- Isolated Central Mounting Hole
- 175°C Operating Temperature
- Fast Switching
- Ease of Paralleling
- Simple Drive Requirements

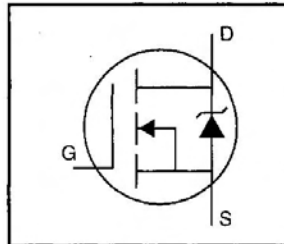

$V_{DSS} = 60V$
 $R_{DS(on)} = 0.028\Omega$
 $I_D = 57A$

• Lead-Free

Description

Third Generation HEXFETs from International Rectifier provide the designer with the best combination of fast switching, ruggedized device design, low on-resistance and cost-effectiveness.

The TO-247 package is preferred for commercial-industrial applications where higher power levels preclude the use of TO-220 devices. The TO-247 is similar but superior to the earlier TO-218 package because of its isolated mounting hole. It also provides greater creepage distance between pins to meet the requirements of most safety specifications.

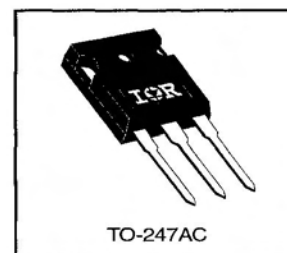

Absolute Maximum Ratings

	Parameter	Max.	Units
$I_D @ T_C = 25^\circ C$	Continuous Drain Current, $V_{GS} @ 10 V$	57	A
$I_D @ T_C = 100^\circ C$	Continuous Drain Current, $V_{GS} @ 10 V$	40	
I_{DM}	Pulsed Drain Current ①	230	
$P_D @ T_C = 25^\circ C$	Power Dissipation	180	W
	Linear Derating Factor	1.2	W/°C
V_{GS}	Gate-to-Source Voltage	± 20	V
E_{AS}	Single Pulse Avalanche Energy ②	53	mJ
dv/dt	Peak Diode Recovery dv/dt ③	4.5	V/ns
T_J T_{STG}	Operating Junction and Storage Temperature Range	-55 to +175	°C
	Soldering Temperature, for 10 seconds	300 (1.6mm from case)	
	Mounting Torque, 6-32 or M3 screw	10 lbf•in (1.1 N•m)	

Thermal Resistance

	Parameter	Min.	Typ.	Max.	Units
$R_{\theta JC}$	Junction-to-Case	—	—	0.83	°C/W
$R_{\theta CS}$	Case-to-Sink, Flat, Greased Surface	—	0.24	—	
$R_{\theta JA}$	Junction-to-Ambient	—	—	40	

IRFP044PbF

International
IR Rectifier

Electrical Characteristics @ $T_J = 25^\circ\text{C}$ (unless otherwise specified)

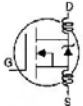
	Parameter	Min.	Typ.	Max.	Units	Test Conditions
$V_{(BR)DSS}$	Drain-to-Source Breakdown Voltage	60	—	—	V	$V_{GS}=0V, I_D=250\mu A$
$\Delta V_{(BR)DSS}/\Delta T_J$	Breakdown Voltage Temp. Coefficient	—	0.060	—	V/ $^\circ\text{C}$	Reference to 25°C , $I_D=1\text{mA}$
$R_{DS(on)}$	Static Drain-to-Source On-Resistance	—	—	0.028	Ω	$V_{GS}=10V, I_D=34A$ ④
$V_{GS(th)}$	Gate Threshold Voltage	2.0	—	4.0	V	$V_{DS}=V_{GS}, I_D=250\mu A$
g_{fs}	Forward Transconductance	17	—	—	S	$V_{DS}=25V, I_D=34A$ ④
I_{DSS}	Drain-to-Source Leakage Current	—	—	25	μA	$V_{DS}=60V, V_{GS}=0V$
		—	—	250		$V_{DS}=48V, V_{GS}=0V, T_J=150^\circ\text{C}$
I_{GSS}	Gate-to-Source Forward Leakage	—	—	100	nA	$V_{GS}=20V$
	Gate-to-Source Reverse Leakage	—	—	-100		$V_{GS}=-20V$
Q_g	Total Gate Charge	—	—	95	nC	$I_D=52A$
Q_{gs}	Gate-to-Source Charge	—	—	27		$V_{DS}=48V$
Q_{gd}	Gate-to-Drain ("Miller") Charge	—	—	46		$V_{GS}=10V$ See Fig. 6 and 13 ④
$t_{d(on)}$	Turn-On Delay Time	—	19	—	ns	$V_{DD}=30V$
t_r	Rise Time	—	120	—		$I_D=52A$
$t_{d(off)}$	Turn-Off Delay Time	—	55	—		$R_G=9.1\Omega$
t_f	Fall Time	—	86	—		$R_D=0.56\Omega$ See Figure 10 ④
L_D	Internal Drain Inductance	—	5.0	—	nH	Between lead, 6 mm (0.25in.) from package and center of die contact 
L_S	Internal Source Inductance	—	13	—		
C_{iss}	Input Capacitance	—	2500	—	pF	$V_{GS}=0V$
C_{oss}	Output Capacitance	—	1200	—		$V_{DS}=25V$
C_{riss}	Reverse Transfer Capacitance	—	200	—		$f=1.0\text{MHz}$ See Figure 5

Source-Drain Ratings and Characteristics

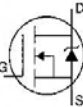
	Parameter	Min.	Typ.	Max.	Units	Test Conditions
I_S	Continuous Source Current (Body Diode)	—	—	57	A	MOSFET symbol showing the integral reverse p-n junction diode. 
I_{SM}	Pulsed Source Current (Body Diode) ①	—	—	230		
V_{SD}	Diode Forward Voltage	—	—	2.5	V	$T_J=25^\circ\text{C}, I_S=57A, V_{GS}=0V$ ④
t_{rr}	Reverse Recovery Time	—	140	300	ns	$T_J=25^\circ\text{C}, I_F=52A$
Q_{rr}	Reverse Recovery Charge	—	1.2	2.8	μC	$di/dt=100A/\mu s$ ④
t_{on}	Forward Turn-On Time	Intrinsic turn-on time is negligible (turn-on is dominated by L_S+L_D)				

Notes:

- ① Repetitive rating; pulse width limited by max. junction temperature (See Figure 11)
- ② $V_{DD}=25V$, starting $T_J=25^\circ\text{C}$, $L=19\mu H$, $R_G=25\Omega$, $I_{AS}=57A$ (See Figure 12)
- ③ $I_{SD}\leq 52A$, $di/dt\leq 250A/\mu s$, $V_{DD}\leq V_{(BR)DSS}$, $T_J\leq 175^\circ\text{C}$
- ④ Pulse width $\leq 300\mu s$; duty cycle $\leq 2\%$.

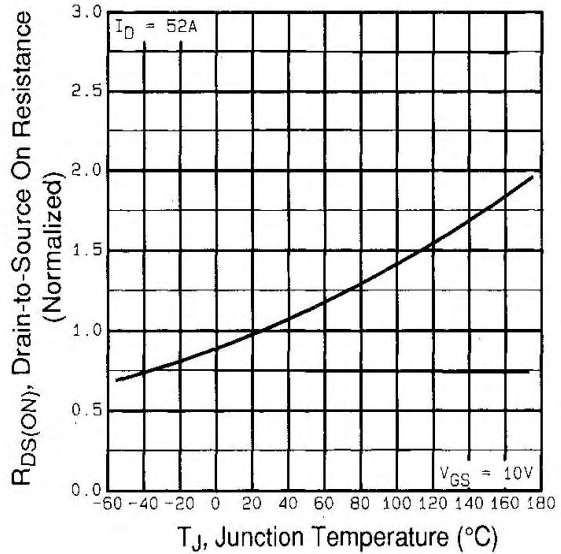
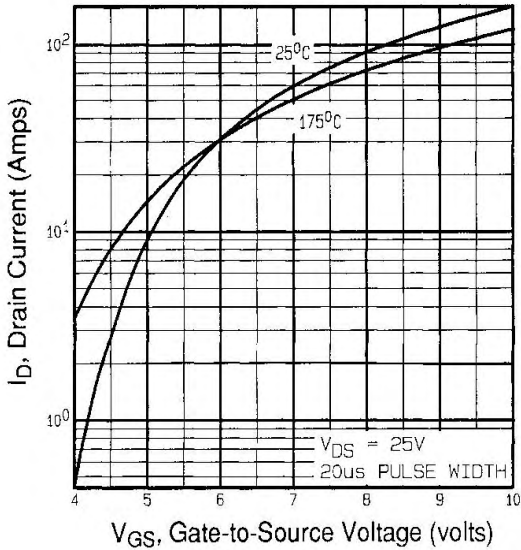
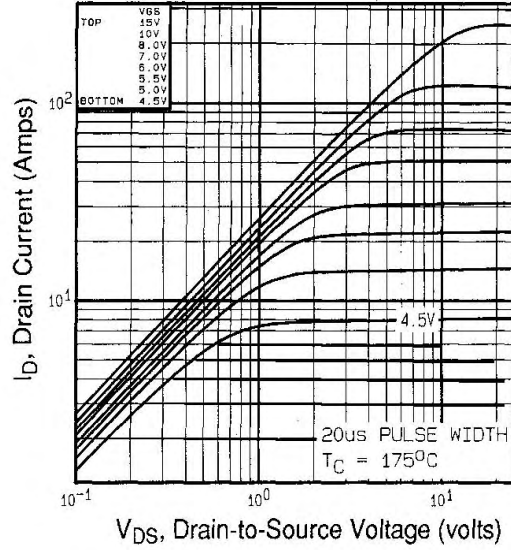
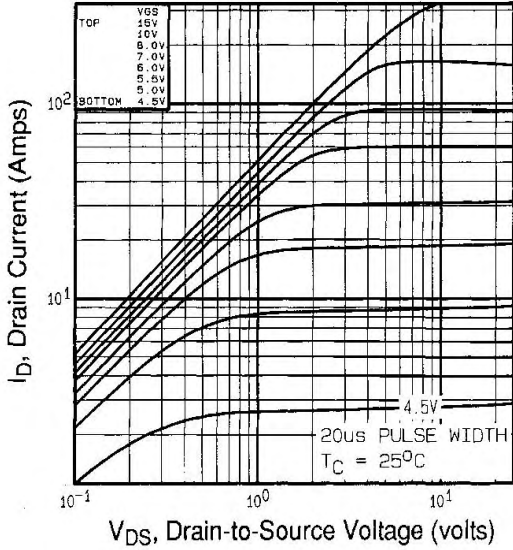

IRFP044PbF

International
IR Rectifier

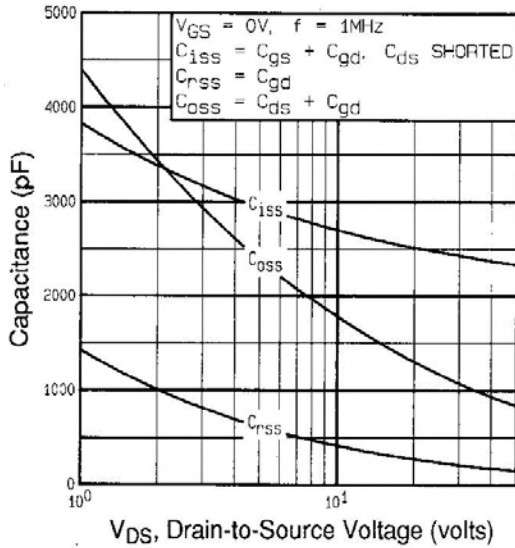

Fig 5. Typical Capacitance Vs. Drain-to-Source Voltage

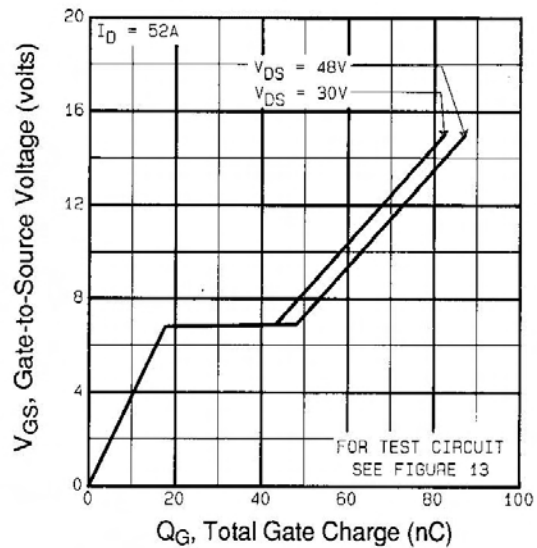

Fig 6. Typical Gate Charge Vs. Gate-to-Source Voltage

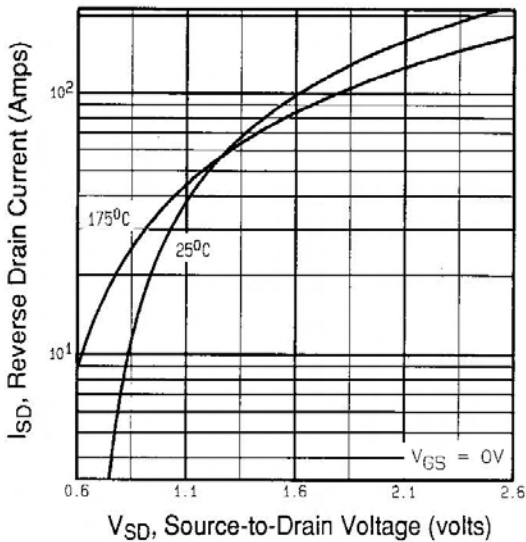

Fig 7. Typical Source-Drain Diode Forward Voltage

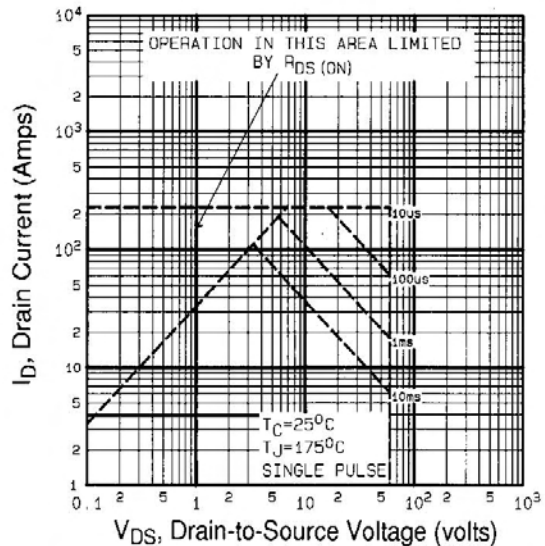

Fig 8. Maximum Safe Operating Area

IRFP044PbF

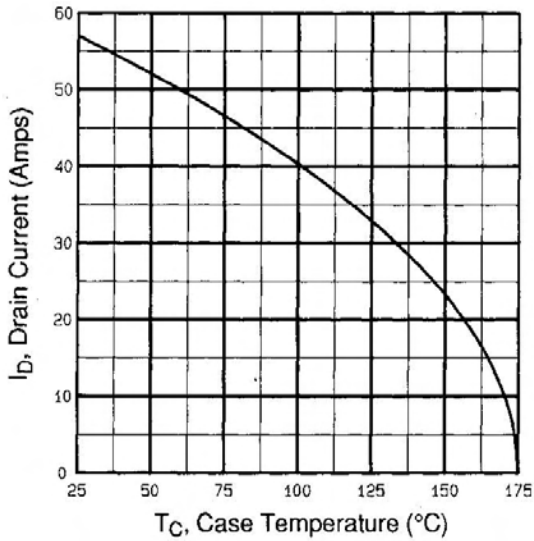

Fig 9. Maximum Drain Current Vs. Case Temperature

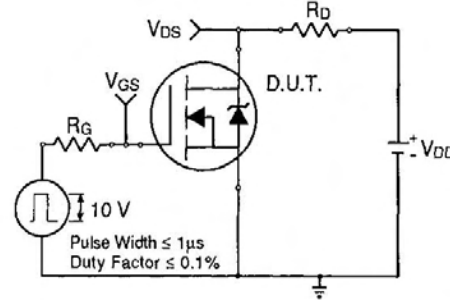

Fig 10a. Switching Time Test Circuit

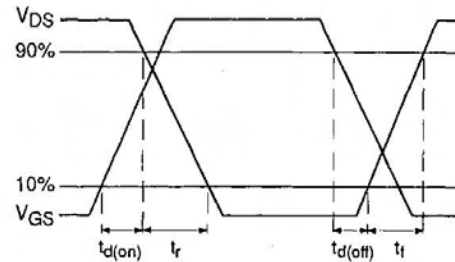

Fig 10b. Switching Time Waveforms

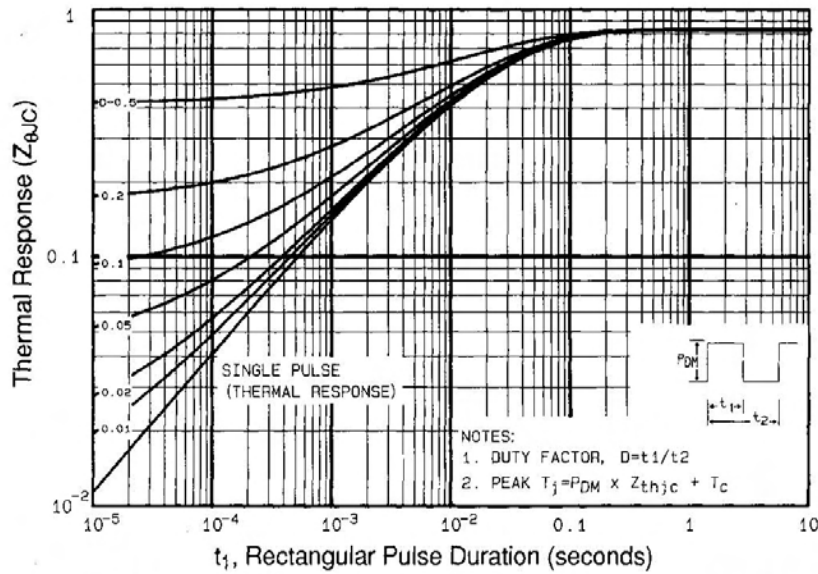

Fig 11. Maximum Effective Transient Thermal Impedance, Junction-to-Case

IRFP044PbF

International
IR Rectifier

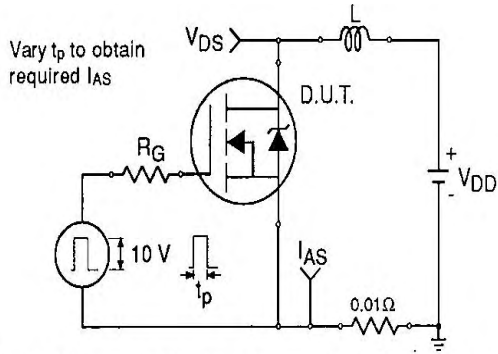

Fig 12a. Unclamped Inductive Test Circuit

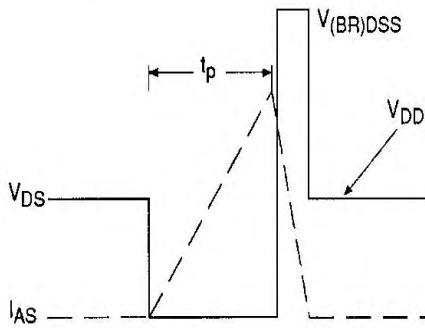

Fig 12b. Unclamped Inductive Waveforms

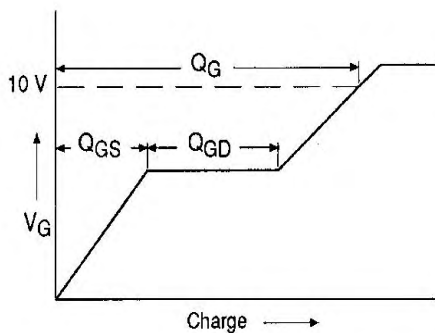

Fig 13a. Basic Gate Charge Waveform

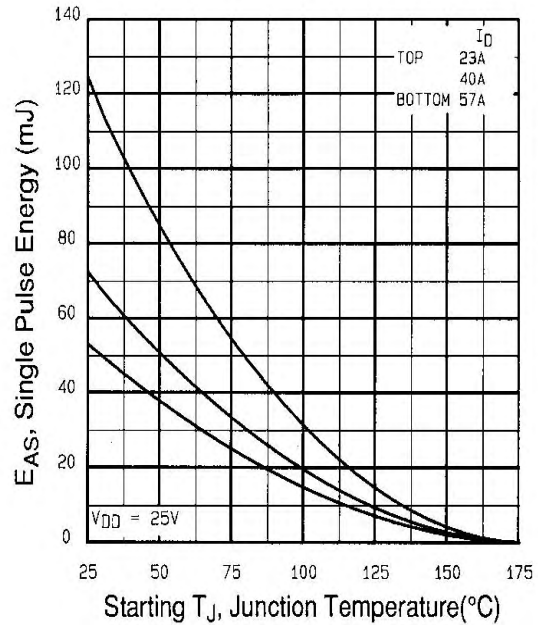

Fig 12c. Maximum Avalanche Energy Vs. Drain Current

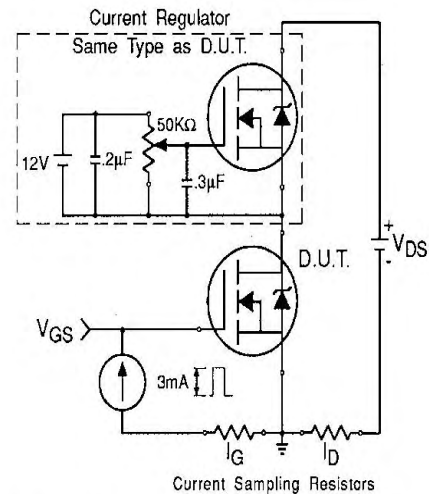
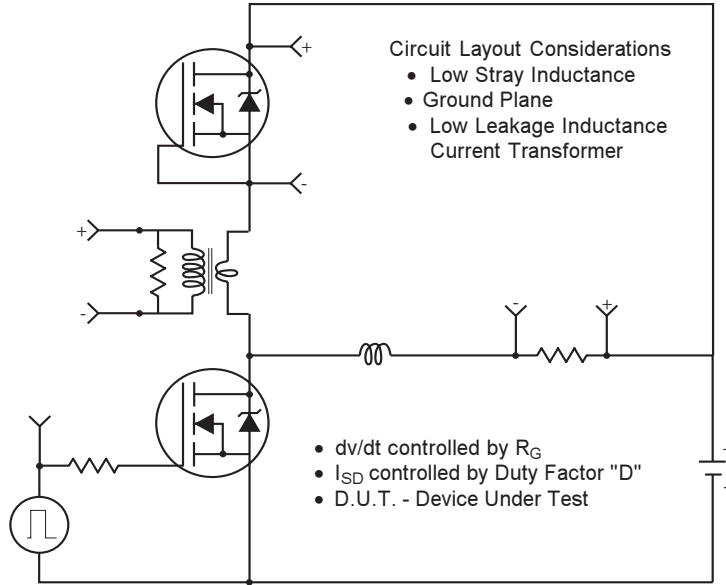

Fig 13b. Gate Charge Test Circuit

Peak Diode Recovery dv/dt Test Circuit



* Reverse Polarity for P-Channel

** Use P-Channel Driver for P-Channel Measurements

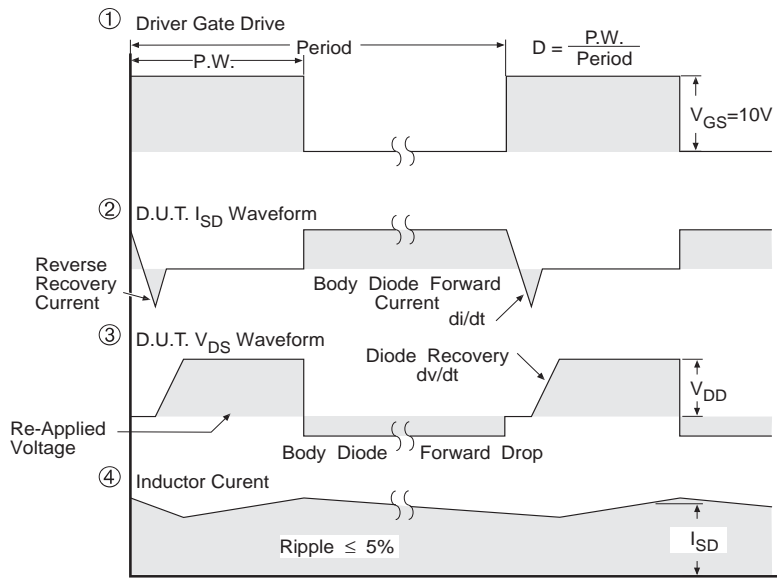

*** $V_{GS} = 5.0V$ for Logic Level and 3V Drive Devices

Fig -14 For N Channel HEXFETS

IRFP044PbF

International
IR Rectifier

TO-247AC Package Outline Dimensions are shown in millimeters (inches)

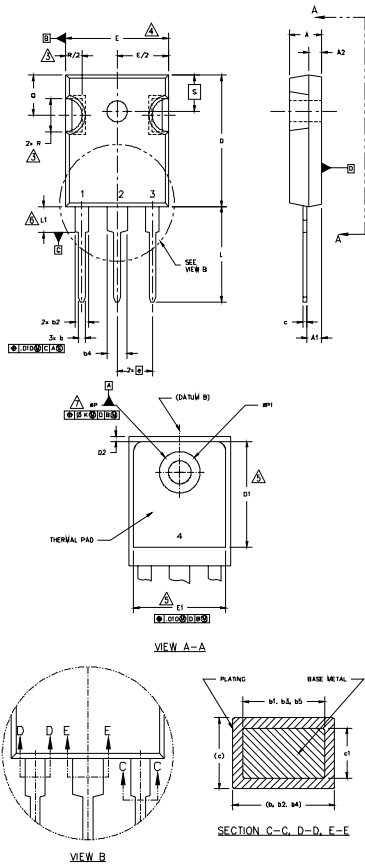

NOTES:

- DIMENSIONING AND TOLERANCING PER ASME Y14.5M 1994.
- DIMENSIONS ARE SHOWN IN INCHES [MILLIMETERS]
- CONTOUR OF SLOT OPTIONAL.
- DIMENSION D & E DO NOT INCLUDE MOLD FLASH. MOLD FLASH SHALL NOT EXCEED .005" (0.127) PER SIDE. THESE DIMENSIONS ARE MEASURED AT THE OUTERMOST EXTREMES OF THE PLASTIC BODY.
- THERMAL PAD CONTOUR OPTIONAL WITHIN DIMENSIONS D1 & E1.
- LEAD FINISH UNCONTROLLED IN L1.
- ØP TO HAVE A MAXIMUM DRAFT ANGLE OF 1.5 ° TO THE TOP OF THE PART WITH A MAXIMUM HOLE DIAMETER OF .154" [3.91].
- OUTLINE CONFORMS TO JEDEC OUTLINE TO-247 WITH THE EXCEPTION OF DIMENSION c.

SYMBOL	DIMENSIONS				NOTES
	INCHES		MILLIMETERS		
	MIN.	MAX.	MIN.	MAX.	
A	.183	.209	4.65	5.31	
A1	.087	.102	2.21	2.59	
A2	.059	.098	1.50	2.49	
b	.039	.055	0.99	1.40	
b1	.039	.053	0.99	1.35	
b2	.065	.094	1.65	2.39	
b3	.065	.092	1.65	2.37	
b4	.102	.135	2.59	3.43	
b5	.102	.133	2.59	3.38	
c	.015	.034	0.38	0.86	
c1	.015	.030	0.38	0.76	
D	.776	.815	19.71	20.70	4
D1	.515	-	13.08	-	5
D2	.020	.030	0.51	0.76	
E	.602	.625	15.29	15.87	4
E1	.540	-	15.72	-	
e	.215 BSC		5.46 BSC		
ek	.010		2.54		
L	.559	.634	14.20	16.10	
L1	.146	.169	3.71	4.29	
N	3		7.62 BSC		
ØP	.140	.144	3.56	3.66	
ØP1	-	.275	-	6.98	
Q	.209	.224	5.31	5.69	
R	.178	.216	4.52	5.49	
S	.217 BSC		5.51 BSC		

LEAD ASSIGNMENTS

HEXFET

1.- GATE
2.- DRAIN
3.- SOURCE
4.- DRAIN

IGBTs, CoPACK

1.- GATE
2.- COLLECTOR
3.- EMITTER
4.- COLLECTOR

DIODES

1.- ANODE/OPEN
2.- CATHODE
3.- ANODE

TO-247AC Part Marking Information

EXAMPLE: THIS IS AN IRFPE30
WITH ASSEMBLY
LOT CODE 5657
ASSEMBLED ON WW 35, 2000
IN THE ASSEMBLY LINE "H"

Note: "P" in assembly line position indicates "Lead-Free"

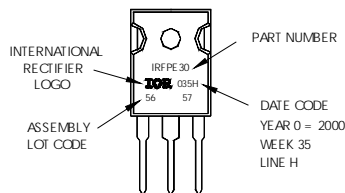

Data and specifications subject to change without notice.

International
IR Rectifier

IR WORLD HEADQUARTERS: 233 Kansas St., El Segundo, California 90245, USA Tel: (310) 252-7105

TAC Fax: (310) 252-7903

Visit us at www.irf.com for sales contact information. 08/04

www.irf.com