

iscN-Channel MOSFET Transistor
IRFP064
• FEATURES

- Low drain-source on-resistance:
 $R_{DS(ON)} \leq 9m\Omega @V_{GS}=10V$
- Enhancement mode:
 $V_{th} = 2.0 \text{ to } 4.0V (V_{DS} = 10 V, I_D=0.25mA)$
- 100% avalanche tested
- Minimum Lot-to-Lot variations for robust device performance and reliable operation

• DESCRIPTION

- Switching Voltage Regulators

• ABSOLUTE MAXIMUM RATINGS($T_a=25^\circ C$)

SYMBOL	PARAMETER	VALUE	UNIT
V_{DSS}	Drain-Source Voltage	60	V
V_{GS}	Gate-Source Voltage	± 20	V
I_D	Drain Current-Continuous	70	A
I_{DM}	Drain Current-Single Pulsed	520	A
P_D	Total Dissipation @ $T_c=25^\circ C$	300	W
T_j	Max. Operating Junction Temperature	-55~175	$^\circ C$
T_{stg}	Storage Temperature	-55~175	$^\circ C$

• THERMAL CHARACTERISTICS

SYMBOL	PARAMETER	MAX	UNIT
$R_{th(ch-c)}$	Channel-to-case thermal resistance	0.5	$^\circ C/W$

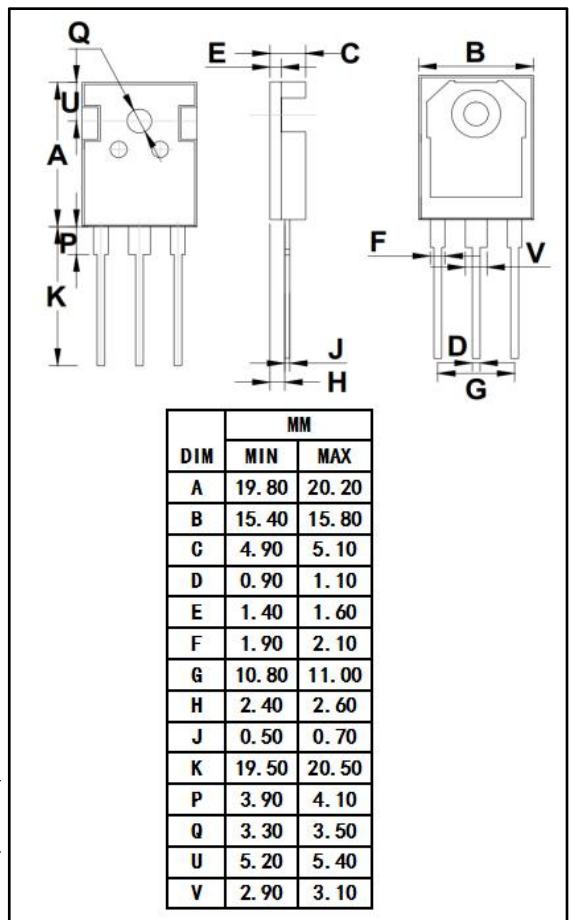
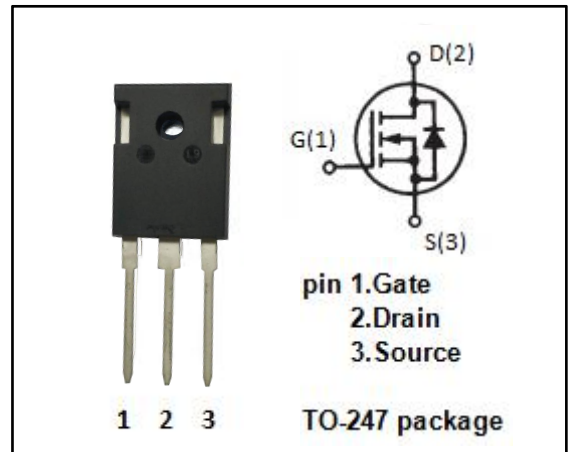

iscN-Channel MOSFET Transistor

IRFP064

ELECTRICAL CHARACTERISTICS

T_c=25°C unless otherwise specified

SYMBOL	PARAMETER	CONDITIONS	MIN	TYP	MAX	UNIT
BV _{DSS}	Drain-Source Breakdown Voltage	V _{GS} =0V; I _D = 0.25mA	60			V
V _{GS(th)}	Gate Threshold Voltage	V _{DS} = 10V; I _D =0.25mA	2.0		4.0	V
R _{DS(on)}	Drain-Source On-Resistance	V _{GS} =10V; I _D =78A			9	mΩ
I _{GSS}	Gate-Source Leakage Current	V _{GS} = ±20V; V _{DS} = 0V			± 100	nA
I _{DSS}	Drain-Source Leakage Current	V _{DS} =60V; V _{GS} = 0V V _{DS} =48V; V _{GS} = 0V; T _J =125°C			25 250	uA
V _{SDF}	Diode forward voltage	I _{DR} =130A, V _{GS} = 0 V			3.0	V

NOTICE:

ISC reserves the rights to make changes of the content herein the datasheet at any time without notification. The information contained herein is presented only as a guide for the applications of our products.

ISC products are intended for usage in general electronic equipment. The products are not designed for use in equipment which require specialized quality and/or reliability, or in equipment which could have applications in hazardous environments, aerospace industry, or medical field. Please contact us if you intend our products to be used in these special applications.

ISC makes no warranty or guarantee regarding the suitability of its products for any particular purpose, nor does ISC assume any liability arising from the application or use of any products, and specifically disclaims any and all liability, including without limitation special, consequential or incidental damages.