

HEXFET® Power MOSFET

Application

- High Efficiency Synchronous Rectification in SMPS
- Uninterruptible Power Supply
- High Speed Power Switching
- Hard Switched and High Frequency Circuits

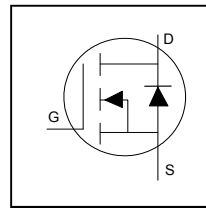

V_{DSS}	300V
R_{DS(on)} typ.	56mΩ
	69mΩ
I_D	38A

Benefits

- Improved Gate, Avalanche and Dynamic dV/dt Ruggedness
- Fully Characterized Capacitance and Avalanche SOA
- Enhanced body diode dV/dt and dI/dt Capability
- Lead-Free, RoHS Compliant

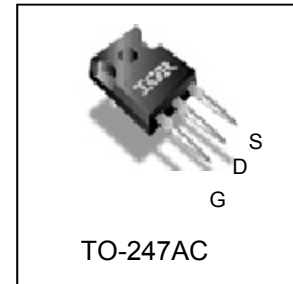

G	D	S
Gate	Drain	Source

Base part number	Package Type	Standard Pack		Orderable Part Number
		Form	Quantity	
IRFP4137PbF	TO-247AC	Tube	25	IRFP4137PbF

	Parameter	Max.	Units
I _D @ T _C = 25°C	Continuous Drain Current, V _{GS} @ 10V	38	A
I _D @ T _C = 100°C	Continuous Drain Current, V _{GS} @ 10V	27	
I _{DM}	Pulsed Drain Current ①	152	
P _D @ T _C = 25°C	Maximum Power Dissipation	341	W
	Linear Derating Factor	2.3	W/°C
V _{GS}	Gate-to-Source Voltage	± 20	V
dv/dt	Peak Diode Recovery dv/dt③	8.9	V/ns
T _J T _{STG}	Operating Junction and Storage Temperature Range	-55 to + 175	°C
	Soldering Temperature, for 10 seconds (1.6mm from case)	300	
	Mounting Torque, 6-32 or M3 Screw	10 lbf-in (1.1 N·m)	

Avalanche Characteristics

E _{AS} (Thermally limited)	Single Pulse Avalanche Energy ②	541	mJ
-------------------------------------	---------------------------------	-----	----

Thermal Resistance

	Parameter	Typ.	Max.	Units
R _{θJC}	Junction-to-Case ④	—	0.44	°C/W
R _{θCS}	Case-to-Sink, Flat Greased Surface	0.24	—	
R _{θJA}	Junction-to-Ambient ⑦⑧	—	40	

Static @ T_J = 25°C (unless otherwise specified)

	Parameter	Min.	Typ.	Max.	Units	Conditions
V _{(BR)DSS}	Drain-to-Source Breakdown Voltage	300	—	—	V	V _{GS} = 0V, I _D = 250μA
ΔV _{(BR)DSS} /ΔT _J	Breakdown Voltage Temp. Coefficient	—	0.24	—	V/°C	Reference to 25°C, I _D = 3.5mA
R _{DS(on)}	Static Drain-to-Source On-Resistance	—	56	69	mΩ	V _{GS} = 10V, I _D = 24A ④
V _{GS(th)}	Gate Threshold Voltage	3.0	—	5.0	V	V _{DS} = V _{GS} , I _D = 250μA
I _{DSS}	Drain-to-Source Leakage Current	—	—	20	μA	V _{DS} = 300V, V _{GS} = 0V
		—	—	250		V _{DS} = 300V, V _{GS} = 0V, T _J = 125°C
I _{GSS}	Gate-to-Source Forward Leakage	—	—	100	nA	V _{GS} = 20V
	Gate-to-Source Reverse Leakage	—	—	-100		V _{GS} = -20V
R _G	Gate Resistance	—	1.3	—	Ω	

Dynamic Electrical Characteristics @ T_J = 25°C (unless otherwise specified)

g _{fs}	Forward Transconductance	45	—	—	S	V _{DS} = 50V, I _D = 24A
Q _g	Total Gate Charge	—	83	125	nC	I _D = 24A
Q _{gs}	Gate-to-Source Charge	—	28	42		V _{DS} = 150V
Q _{gd}	Gate-to-Drain Charge	—	26	39		V _{GS} = 10V
t _{d(on)}	Turn-On Delay Time	—	18	—	ns	V _{DD} = 195V
t _r	Rise Time	—	23	—		I _D = 24A
t _{d(off)}	Turn-Off Delay Time	—	34	—		R _G = 2.2Ω
t _f	Fall Time	—	20	—		V _{GS} = 10V
C _{iss}	Input Capacitance	—	5168	—	pF	V _{GS} = 0V
C _{oss}	Output Capacitance	—	300	—		V _{DS} = 50V
C _{rss}	Reverse Transfer Capacitance	—	77	—		f = 1.0MHz
C _{oss eff.(ER)}	Effective Output Capacitance (Energy Related)	—	196	—		V _{GS} = 0V, V _{DS} = 0V to 240V ^⑥
C _{oss eff.(TR)}	Output Capacitance (Time Related)	—	265	—		See Fig.11
						V _{GS} = 0V, V _{DS} = 0V to 240V ^⑤

Diode Characteristics

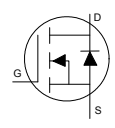
	Parameter	Min.	Typ.	Max.	Units	Conditions
I _S	Continuous Source Current (Body Diode) ①	—	—	40	A	MOSFET symbol showing the integral reverse p-n junction diode. 
I _{SM}	Pulsed Source Current (Body Diode) ①	—	—	160		
V _{SD}	Diode Forward Voltage	—	—	1.3	V	T _J = 25°C, I _S = 24A, V _{GS} = 0V ④
t _{rr}	Reverse Recovery Time	—	302	—	ns	T _J = 25°C V _{DD} = 255V
		—	379	—		T _J = 125°C I _F = 24A,
Q _{rr}	Reverse Recovery Charge	—	1739	—	nC	T _J = 25°C di/dt = 100A/μs ④
		—	2497	—		T _J = 125°C
I _{RSM}	Reverse Recovery Current	—	13	—	A	T _J = 25°C

Notes:

- ① Repetitive rating; pulse width limited by max. junction temperature.
- ② Recommended max EAS limit, starting T_J = 25°C, L = 2.05mH, R_G = 50Ω, I_{AS} = 24A, V_{GS} = 10V.
- ③ I_{SD} ≤ 24A, di/dt ≤ 1771A/μs, V_{DD} ≤ V_{(BR)DSS}, T_J ≤ 175°C.
- ④ Pulse width ≤ 400μs; duty cycle ≤ 2%.
- ⑤ C_{oss eff. (TR)} is a fixed capacitance that gives the same charging time as C_{oss} while V_{DS} is rising from 0 to 80% V_{DSS}.
- ⑥ C_{oss eff. (ER)} is a fixed capacitance that gives the same energy as C_{oss} while V_{DS} is rising from 0 to 80% V_{DSS}.
- ⑦ When mounted on 1" square PCB (FR-4 or G-10 Material). For recommended footprint and soldering techniques refer to application note #AN-994
- ⑧ R_θ is measured at T_J approximately 90°C

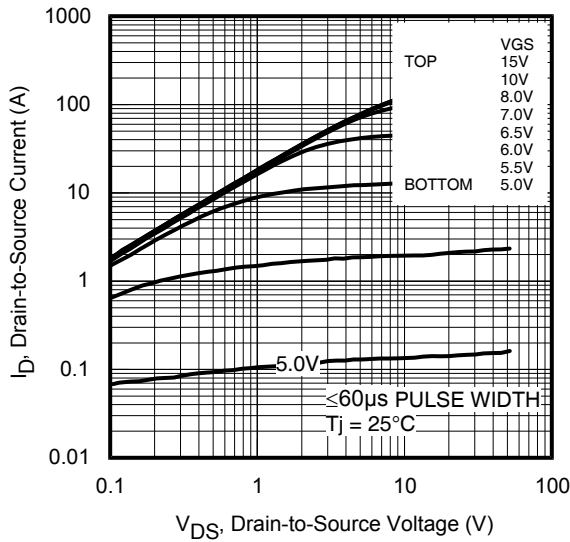
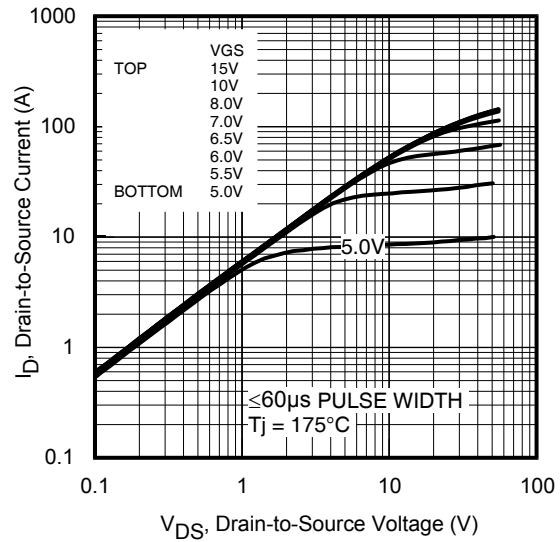
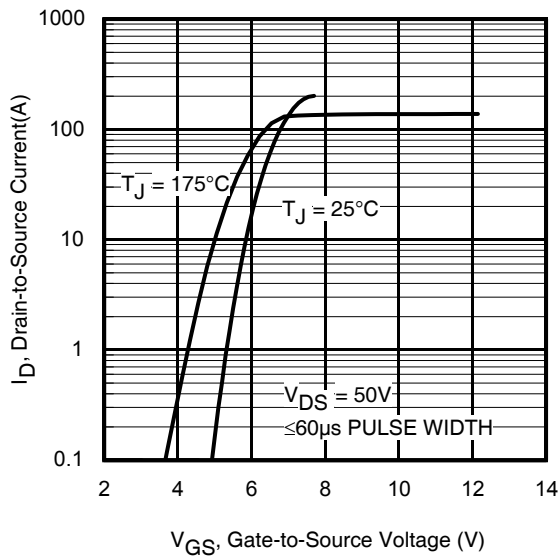
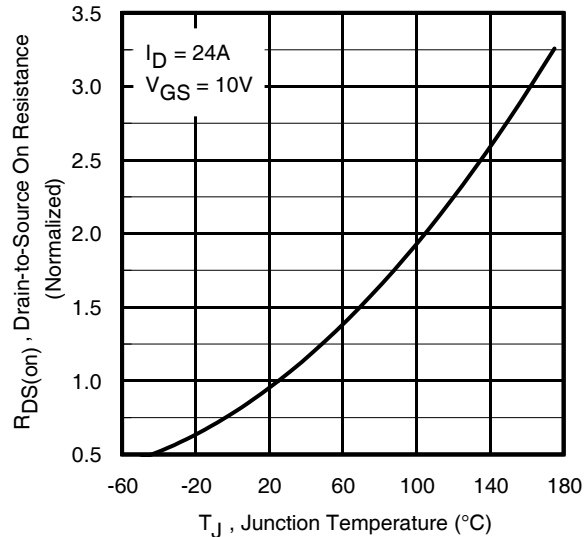
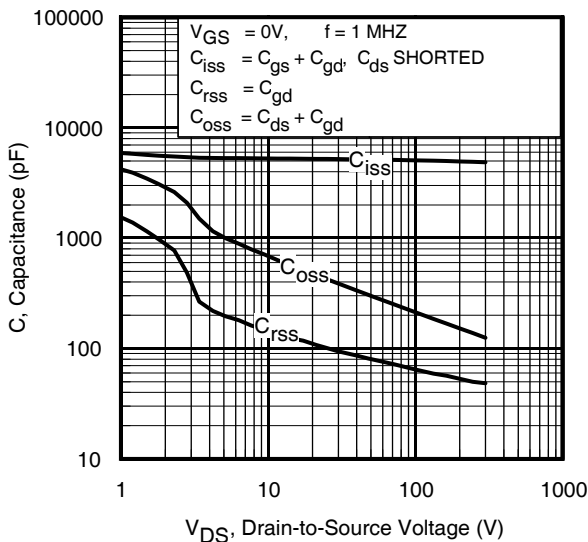
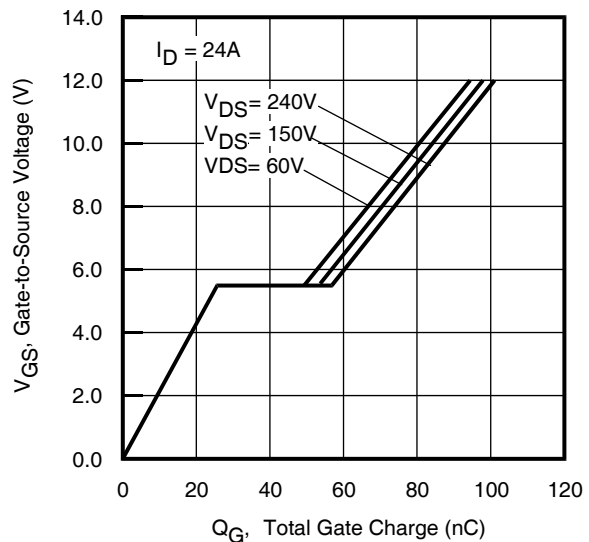
Fig 1. Typical Output Characteristics

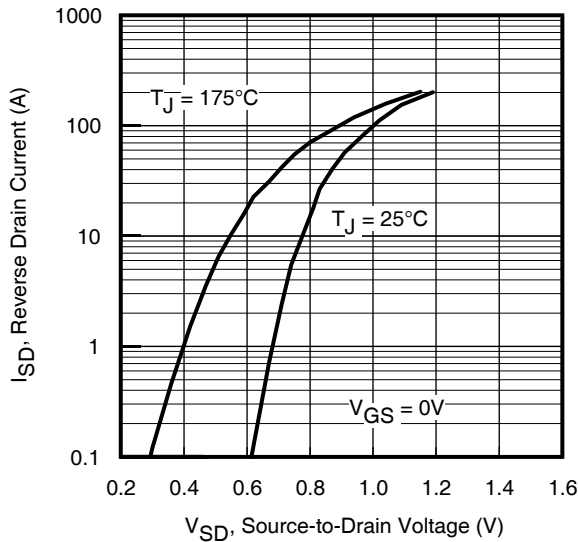
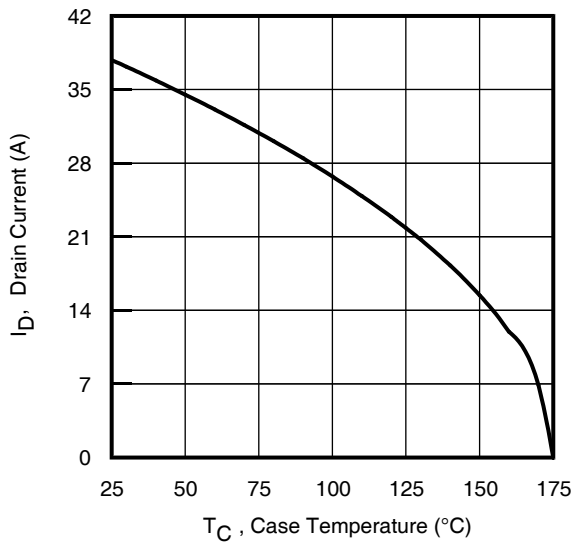
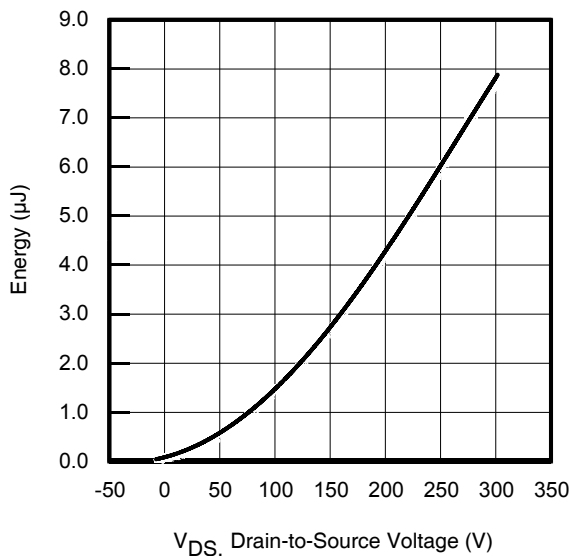
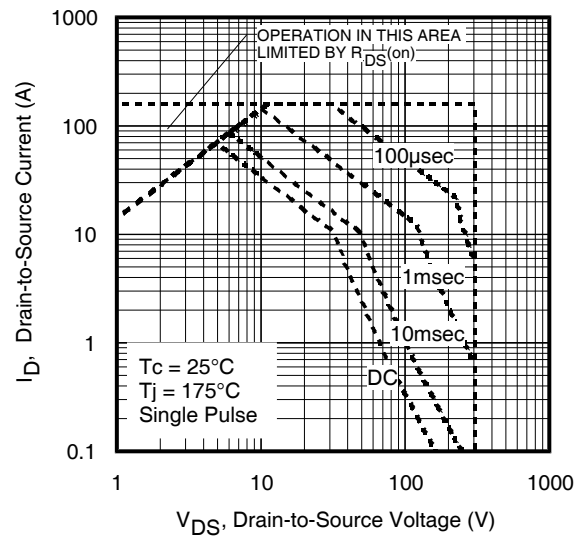
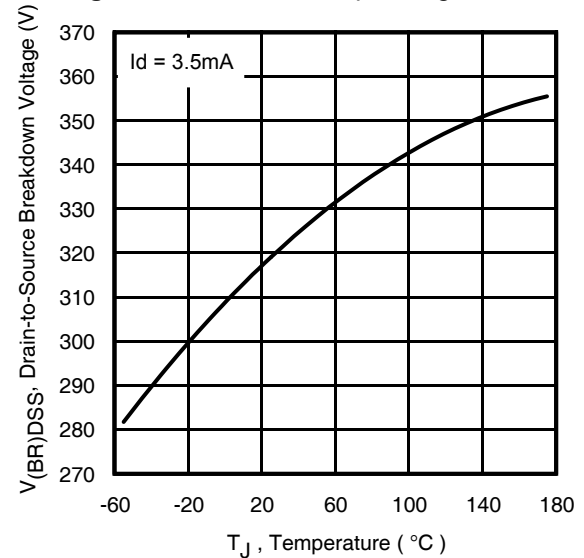
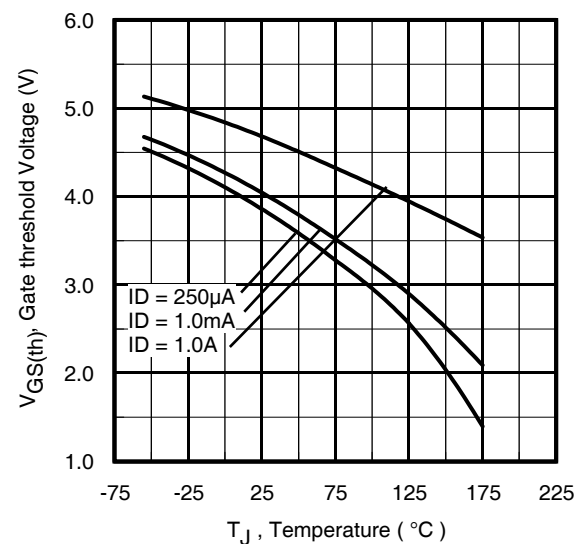
Fig 2. Typical Output Characteristics

Fig 3. Typical Transfer Characteristics

Fig 4. Normalized On-Resistance vs. Temperature

Fig 5. Typical Capacitance vs. Drain-to-Source Voltage

Fig 6. Typical Gate Charge vs. Gate-to-Source Voltage

Fig 7. Typical Source-Drain Diode Forward Voltage

Fig 9. Maximum Drain Current vs. Case Temperature

Fig 11. Typical C_{oss} Stored Energy

Fig 8. Maximum Safe Operating Area

Fig 10. Drain-to-Source Breakdown Voltage

Fig 12. Threshold Voltage vs. Temperature

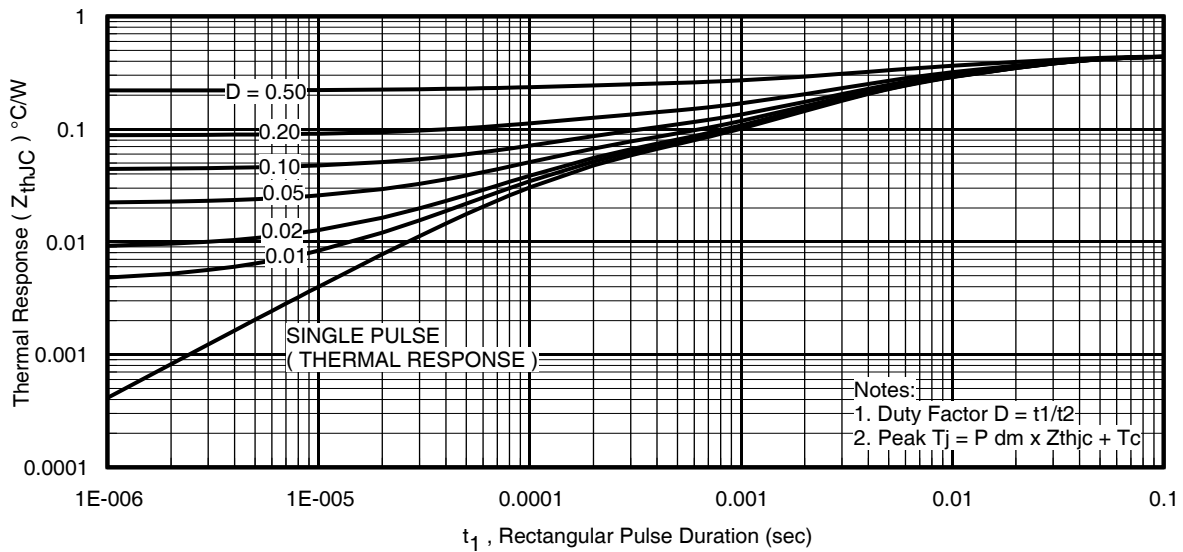

Fig 13. Maximum Effective Transient Thermal Impedance, Junction-to-Case

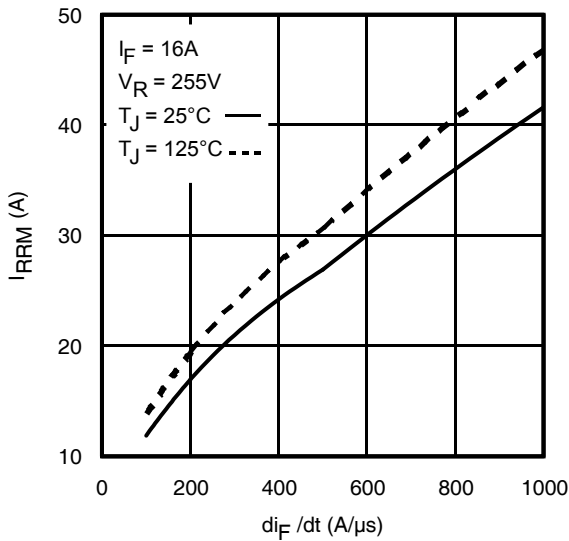

Fig 14. Typical Recovery Current vs. dif/dt

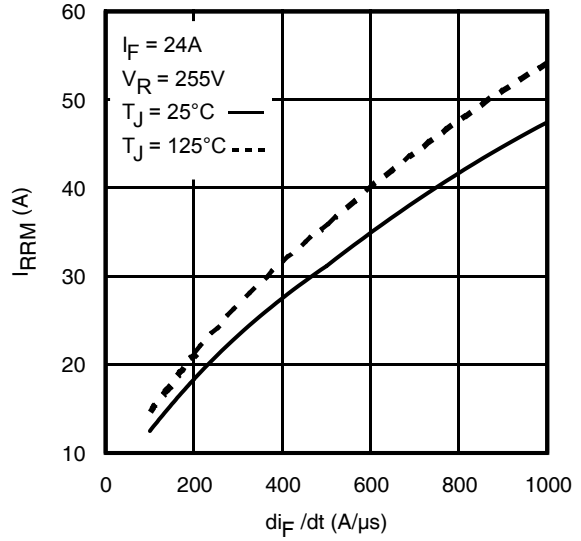

Fig 15. Typical Recovery Current vs. dif/dt

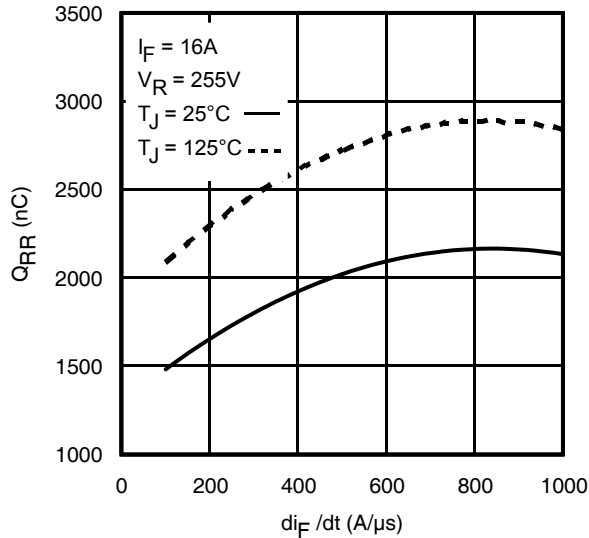

Fig 16. Typical Stored Charge vs. dif/dt

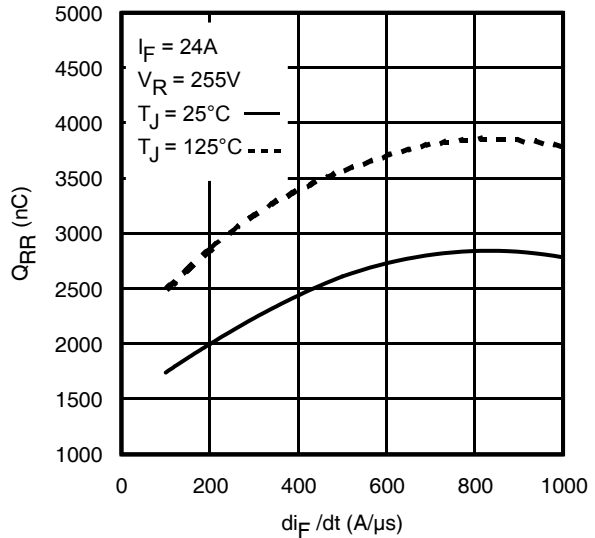
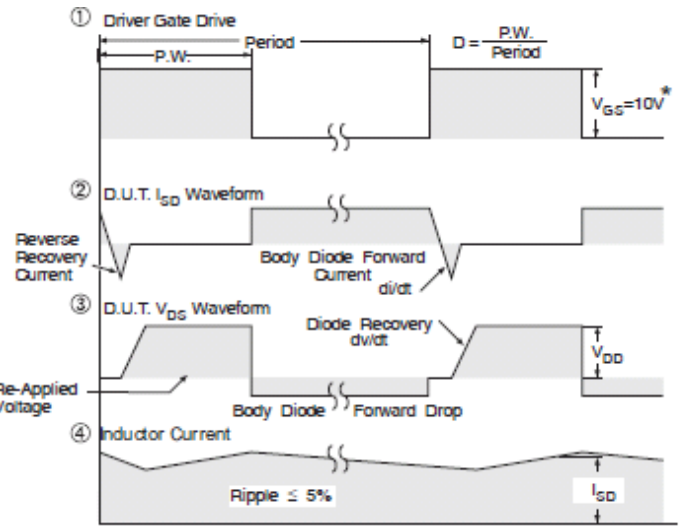
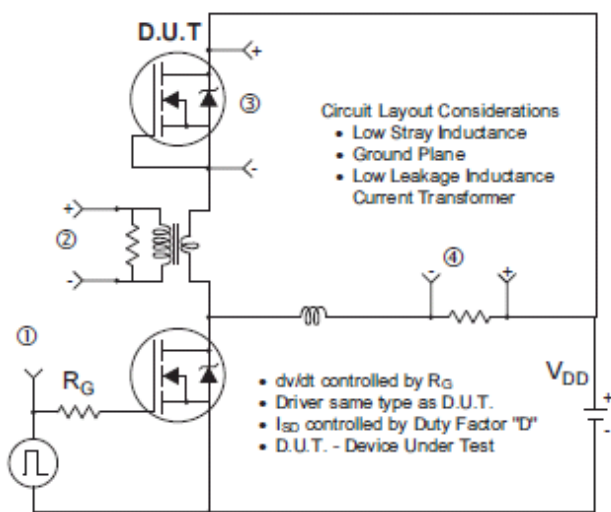

Fig 17. Typical Stored Charge vs. dif/dt



* $V_{GS} = 5V$ for Logic Level Devices

Fig 18. Peak Diode Recovery dv/dt Test Circuit for N-Channel HEXFET® Power MOSFETs

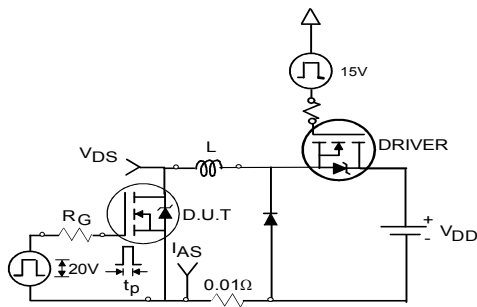

Fig 19a. Unclamped Inductive Test Circuit

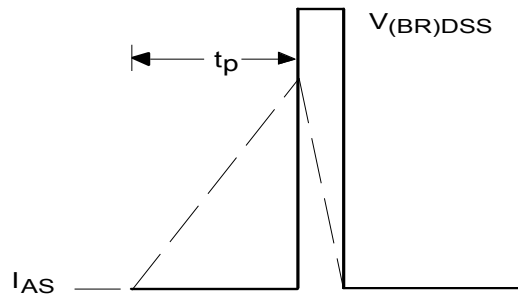

Fig 19b. Unclamped Inductive Waveforms

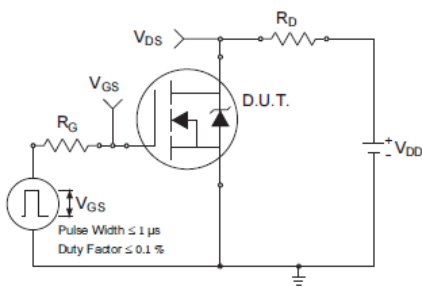

Fig 20a. Switching Time Test Circuit

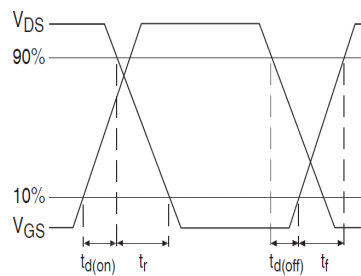

Fig 20b. Switching Time Waveforms

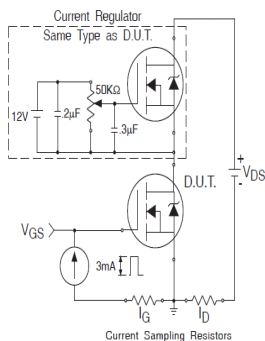

Fig 21a. Gate Charge Test Circuit

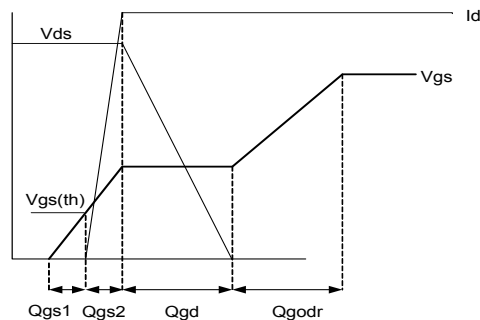
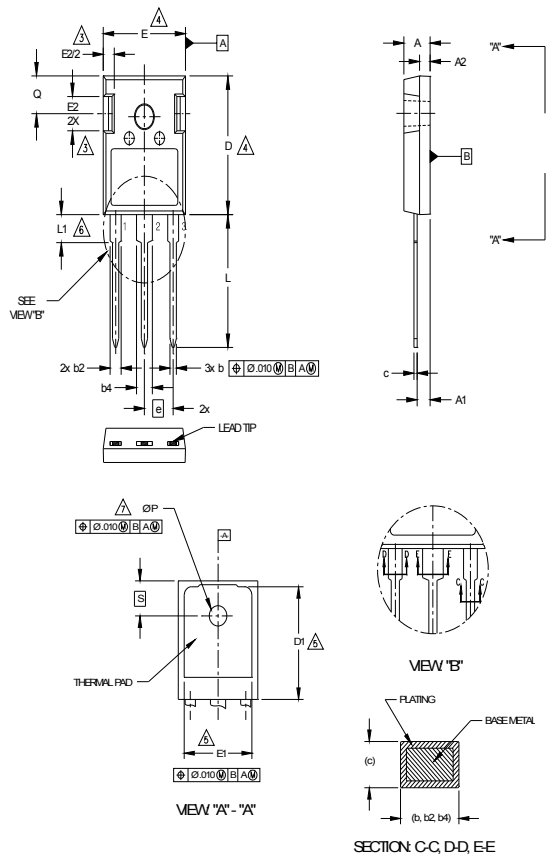

Fig 21b. Gate Charge Waveform

TO-247AC Package Outline

Dimensions are shown in millimeters (inches)



SYMBOL	DIMENSIONS				NOTES
	INCHES		MILLIMETERS		
	MIN.	MAX.	MIN.	MAX.	
A	.190	.204	4.83	5.20	
A1	.090	.100	2.29	2.54	
A2	.075	.085	1.91	2.16	
b	.042	.052	1.07	1.33	
b2	.075	.094	1.91	2.41	
b4	.113	.133	2.87	3.38	
c	.022	.026	0.55	0.68	
D	.819	.830	20.80	21.10	4
D1	.640	.694	16.25	17.65	5
E	.620	.635	15.75	16.13	4
E1	.512	.570	13.00	14.50	
E2	.145	.196	3.68	5.00	
e	.215 Typical		5.45 Typical		
L	.780	.800	19.80	20.32	
L1	.161	.173	4.10	4.40	
Ø P	.138	.143	3.51	3.65	
Q	.216	.236	5.49	6.00	
S	.238	.248	6.04	6.30	

LEAD ASSIGNMENTS
HEXFET

- 1.- GATE
- 2.- DRAIN
- 3.- SOURCE
- 4.- DRAIN

IGBTs, CoPACK

- 1.- GATE
- 2.- COLLECTOR
- 3.- EMITTER
- 4.- COLLECTOR

DIODES

- 1.- ANODE/OPEN
- 2.- CATHODE
- 3.- ANODE

NOTES:

- 1 DIMENSIONING AND TOLERANCING AS PER ASME Y14.5M 1994.
- 2 DIMENSIONS ARE SHOWN IN INCHES AND MILLIMETERS.
- △ CONTOUR OF SLOT OPTIONAL.
- △ DIMENSION D & E DO NOT INCLUDE MOLD FLASH. MOLD FLASH SHALL NOT EXCEED .005" (0.127) PER SIDE. THESE DIMENSIONS ARE MEASURED AT THE OUTERMOST EXTREMES OF THE PLASTIC BODY.
- △ THERMAL PAD CONTOUR OPTIONAL WITHIN DIMENSIONS D1 & E1.
- △ LEAD FINISH UNCONTROLLED IN L1.
- △ Ø P TO HAVE A MAXIMUM DRAFT ANGLE OF 1.5 ° TO THE TOP OF THE PART WITH A MAXIMUM HOLE DIAMETER OF .154 INCH.

TO-247AC Part Marking Information

Notes: This part marking information applies to devices produced after 02/26/2001

EXAMPLE: THIS IS AN IRFPE30
WITH ASSEMBLY
LOT CODE 5657
ASSEMBLED ON WW 35, 2001
IN THE ASSEMBLY LINE "H"

Note: "P" in assembly line position
indicates "Lead-Free"

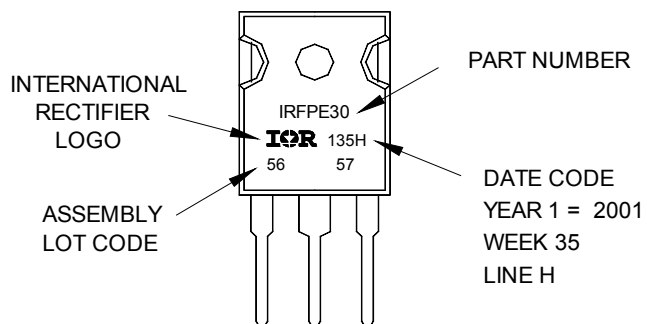

TO-247AC package is not recommended for Surface Mount Application.

Note: For the most current drawing please refer to IR website at <http://www.irf.com/package/>

Qualification Information†

Qualification Level	Industrial (per JEDEC JESD47F) ††	
Moisture Sensitivity Level	TO-247AC	N/A
RoHS Compliant	Yes	

† Qualification standards can be found at International Rectifier’s web site: <http://www.irf.com/product-info/reliability/>

†† Applicable version of JEDEC standard at the time of product release.

Data and specifications subject to change without notice.



IR WORLD HEADQUARTERS: 101N Sepulveda., El Segundo, California 90245, USA Tel: (310) 252-7105

TAC Fax: (310) 252-7903

Visit us at www.irf.com for sales contact information.