

FEATURES

- Avalanche Rugged Technology
- Rugged Gate Oxide Technology
- Lower Input Capacitance
- Improved Gate Charge
- Extended Safe Operating Area
- Lower Leakage Current : 10 μ A (Max.) @ $V_{DS} = 400V$
- Lower $R_{DS(ON)}$: 1.408 Ω (Typ.)

$$BV_{DSS} = 400 V$$

$$R_{DS(on)} = 1.8 \Omega$$

$$I_D = 3.1 A$$

D-PAK I-PAK

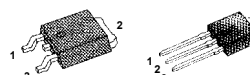

1. Gate 2. Drain 3. Source

Absolute Maximum Ratings

| Symbol | Characteristic | Value | Units |
|----------------|---|--------------|---------------|
| V_{DSS} | Drain-to-Source Voltage | 400 | V |
| I_D | Continuous Drain Current ($T_C=25^\circ C$) | 3.1 | A |
| | Continuous Drain Current ($T_C=100^\circ C$) | 2 | |
| I_{DM} | Drain Current-Pulsed ① | 12 | A |
| V_{GS} | Gate-to-Source Voltage | ± 30 | V |
| E_{AS} | Single Pulsed Avalanche Energy ② | 220 | mJ |
| I_{AR} | Avalanche Current ① | 3.1 | A |
| E_{AR} | Repetitive Avalanche Energy ① | 4.1 | mJ |
| dv/dt | Peak Diode Recovery dv/dt ③ | 4.0 | V/ns |
| P_D | Total Power Dissipation ($T_A=25^\circ C$) * | 2.5 | W |
| | Total Power Dissipation ($T_C=25^\circ C$) | 41 | W |
| | Linear Derating Factor | 0.33 | W/ $^\circ C$ |
| T_J, T_{STG} | Operating Junction and Storage Temperature Range | - 55 to +150 | $^\circ C$ |
| T_L | Maximum Lead Temp. for Soldering Purposes, 1/8" from case for 5-seconds | 300 | |

Thermal Resistance

| Symbol | Characteristic | Typ. | Max. | Units |
|-----------------|-----------------------|------|------|--------------|
| $R_{\theta JC}$ | Junction-to-Case | -- | 3.05 | $^\circ C/W$ |
| $R_{\theta JA}$ | Junction-to-Ambient * | -- | 50 | |
| $R_{\theta JA}$ | Junction-to-Ambient | -- | 110 | |

* When mounted on the minimum pad size recommended (PCB Mount).

Electrical Characteristics ($T_C=25^\circ\text{C}$ unless otherwise specified)

| Symbol | Characteristic | Min. | Typ. | Max. | Units | Test Condition |
|------------------------|---|------|------|------|------------|---|
| BV_{DSS} | Drain-Source Breakdown Voltage | 400 | -- | -- | V | $V_{GS}=0V, I_D=250\mu A$ |
| $\Delta BV/\Delta T_J$ | Breakdown Voltage Temp. Coeff. | -- | 0.54 | -- | V/°C | $I_D=250\mu A$ See Fig 7 |
| $V_{GS(th)}$ | Gate Threshold Voltage | 2.0 | -- | 4.0 | V | $V_{DS}=5V, I_D=250\mu A$ |
| I_{GSS} | Gate-Source Leakage, Forward | -- | -- | 100 | nA | $V_{GS}=30V$ |
| | Gate-Source Leakage, Reverse | -- | -- | -100 | | $V_{GS}=-30V$ |
| I_{DSS} | Drain-to-Source Leakage Current | -- | -- | 10 | μA | $V_{DS}=400V$ |
| | | -- | -- | 100 | | $V_{DS}=320V, T_C=125^\circ\text{C}$ |
| $R_{DS(on)}$ | Static Drain-Source On-State Resistance | -- | -- | 1.8 | Ω | $V_{GS}=10V, I_D=1.55A$ ④ |
| g_{fs} | Forward Transconductance | -- | 2.27 | -- | S | $V_{DS}=50V, I_D=1.55A$ ④ |
| C_{iss} | Input Capacitance | -- | 385 | 500 | pF | $V_{GS}=0V, V_{DS}=25V, f=1\text{MHz}$ See Fig 5 |
| C_{oss} | Output Capacitance | -- | 60 | 70 | | |
| C_{rss} | Reverse Transfer Capacitance | -- | 27 | 33 | | |
| $t_{d(on)}$ | Turn-On Delay Time | -- | 12 | 35 | ns | $V_{DD}=200V, I_D=3.3A,$ $R_G=18\Omega$ See Fig 13 ④ ⑤ |
| t_r | Rise Time | -- | 17 | 45 | | |
| $t_{d(off)}$ | Turn-Off Delay Time | -- | 51 | 110 | | |
| t_f | Fall Time | -- | 18 | 45 | | |
| Q_g | Total Gate Charge | -- | 19 | 26 | nC | $V_{DS}=320V, V_{GS}=10V,$ $I_D=3.3A$ See Fig 6 & Fig 12 ④ ⑤ |
| Q_{gs} | Gate-Source Charge | -- | 2.7 | -- | | |
| Q_{gd} | Gate-Drain("Miller") Charge | -- | 11.1 | -- | | |

Source-Drain Diode Ratings and Characteristics

| Symbol | Characteristic | Min. | Typ. | Max. | Units | Test Condition |
|----------|---------------------------|------|------|------|---------------|---|
| I_S | Continuous Source Current | -- | -- | 3.1 | A | Integral reverse pn-diode in the MOSFET |
| I_{SM} | Pulsed-Source Current ① | -- | -- | 12 | | |
| V_{SD} | Diode Forward Voltage ④ | -- | -- | 1.5 | V | $T_J=25^\circ\text{C}, I_S=3.1A, V_{GS}=0V$ |
| t_{rr} | Reverse Recovery Time | -- | 230 | -- | ns | $T_J=25^\circ\text{C}, I_F=3.3A$ |
| Q_{rr} | Reverse Recovery Charge | -- | 1.16 | -- | μC | $di_F/dt=100A/\mu\text{s}$ ④ |

Notes ;

- ① Repetitive Rating : Pulse Width Limited by Maximum Junction Temperature
- ② $L=40\text{mH}, I_{AS}=3.1A, V_{DD}=50V, R_G=27\Omega$, Starting $T_J=25^\circ\text{C}$
- ③ $I_{SD} \leq 3.3A, di/dt \leq 110A/\mu\text{s}, V_{DD} \leq BV_{DSS}$, Starting $T_J=25^\circ\text{C}$
- ④ Pulse Test : Pulse Width = $250\mu\text{s}$, Duty Cycle $\leq 2\%$
- ⑤ Essentially Independent of Operating Temperature

Fig 1. Output Characteristics

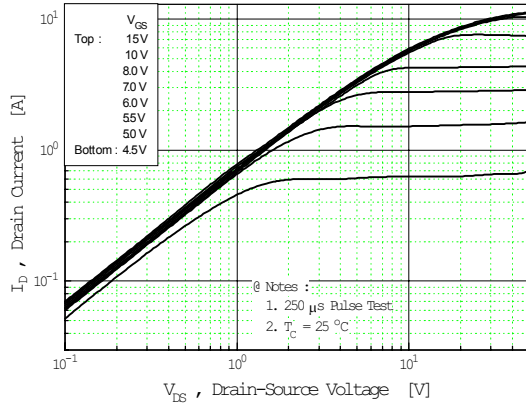

Fig 2. Transfer Characteristics

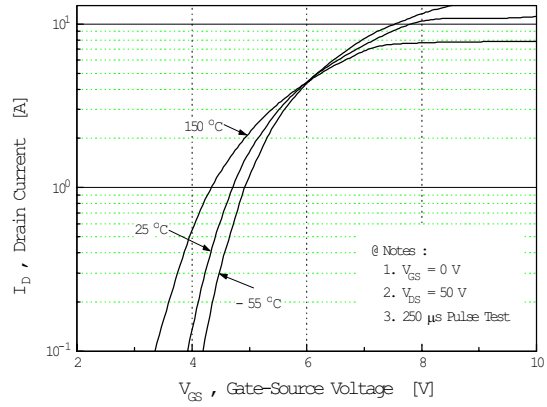

Fig 3. On-Resistance vs. Drain Current

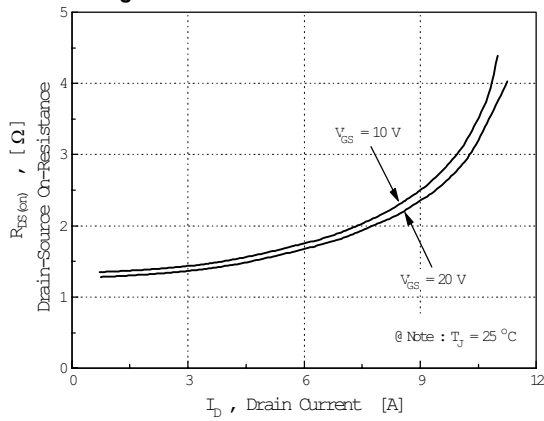

Fig 4. Source-Drain Diode Forward Voltage

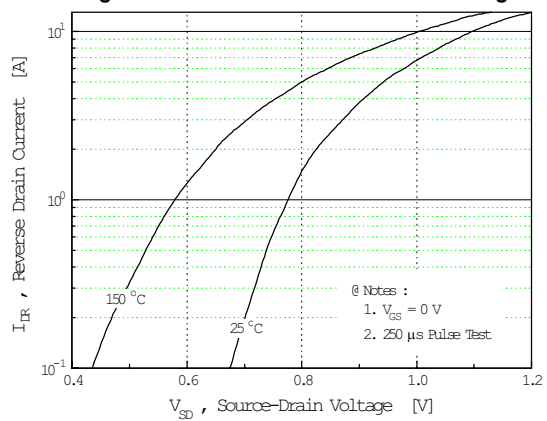

Fig 5. Capacitance vs. Drain-Source Voltage

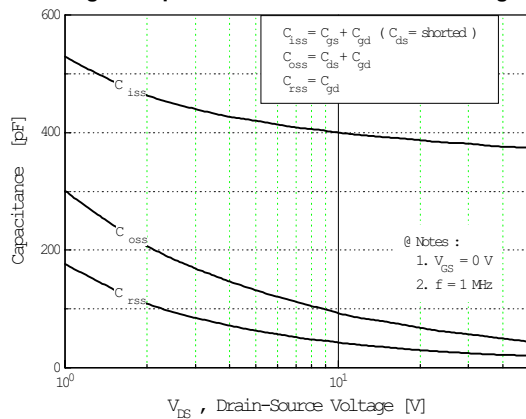
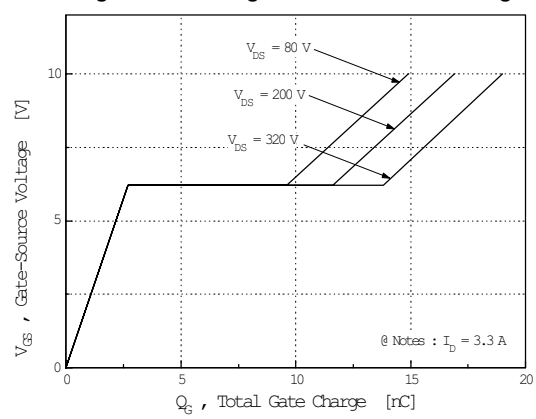

Fig 6. Gate Charge vs. Gate-Source Voltage



IRFR/U320A

N-CHANNEL POWER MOSFET

Fig 7. Breakdown Voltage vs. Temperature

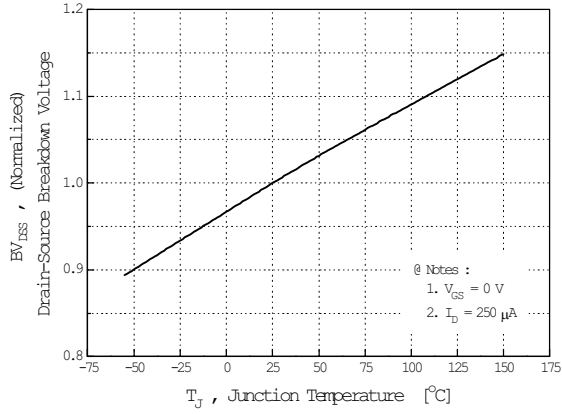

Fig 8. On-Resistance vs. Temperature

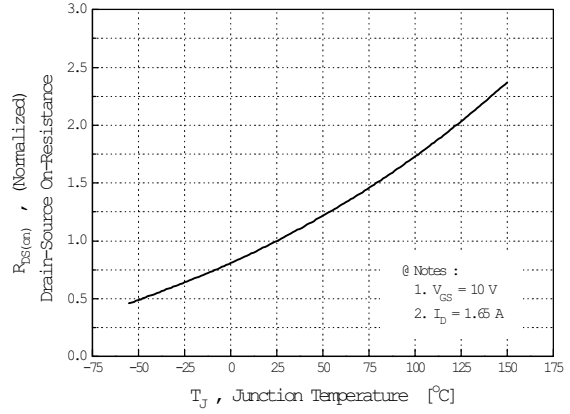

Fig 9. Max. Safe Operating Area

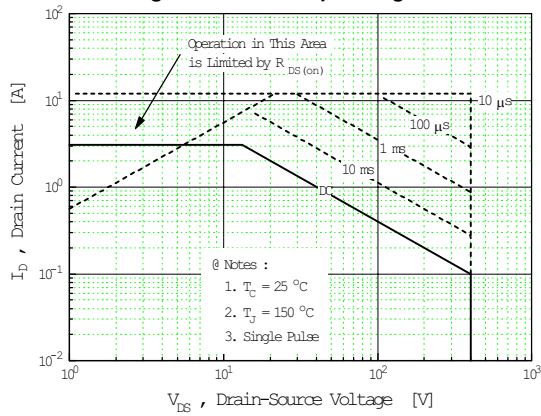

Fig 10. Max. Drain Current vs. Case Temperature

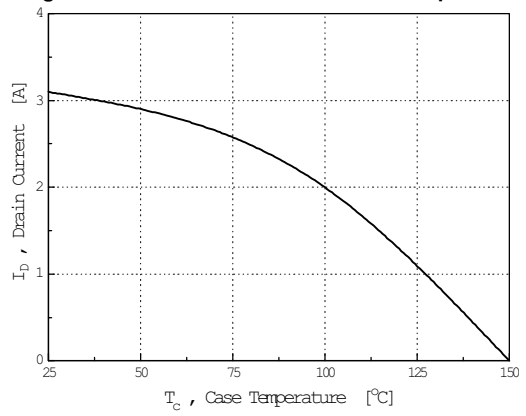

Fig 11. Thermal Response

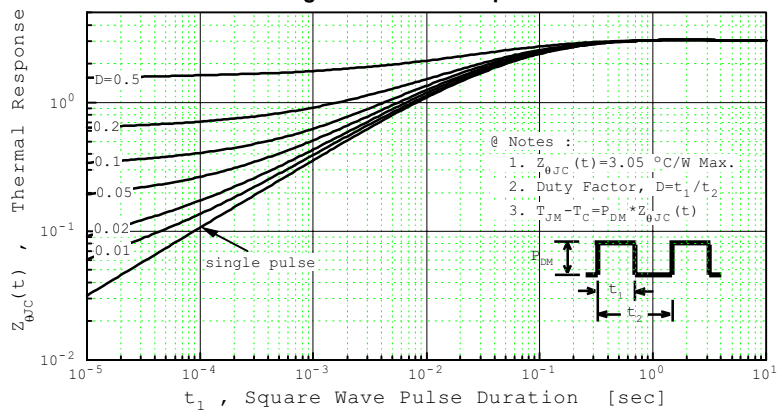

Fig 12. Gate Charge Test Circuit & Waveform

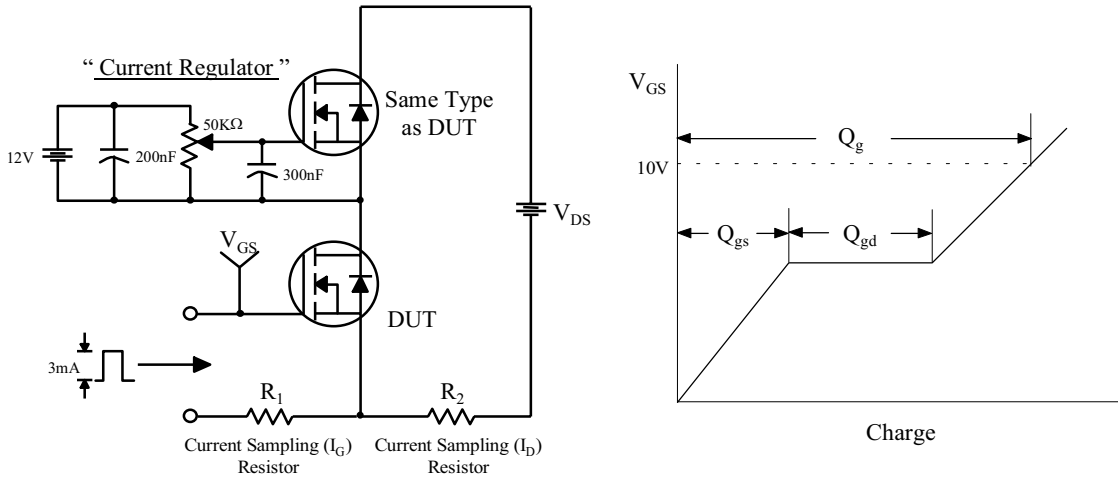

Fig 13. Resistive Switching Test Circuit & Waveforms

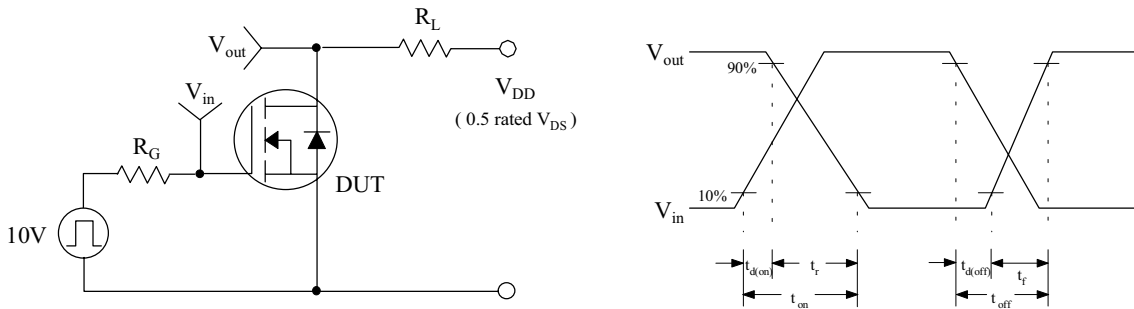

Fig 14. Unclamped Inductive Switching Test Circuit & Waveforms

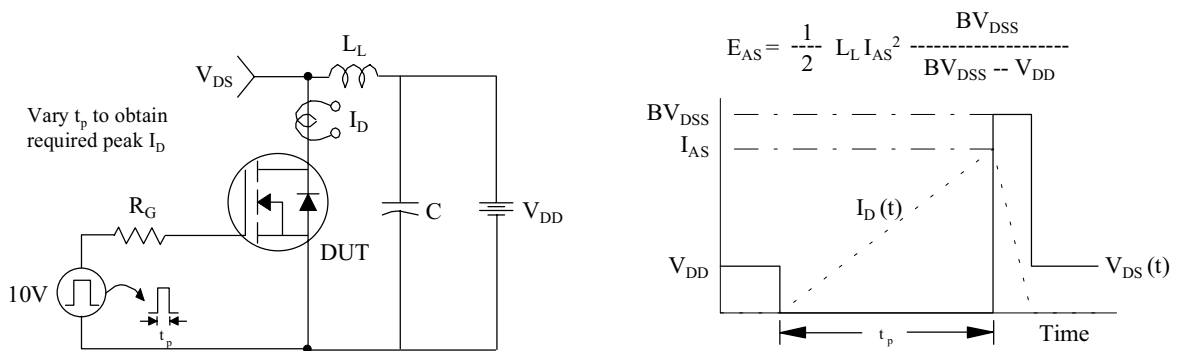

Fig 15. Peak Diode Recovery dv/dt Test Circuit & Waveforms

